

US00D600732S

(12) **United States Design Patent**  
**Kim**

(10) **Patent No.:** **US D600,732 S**

(45) **Date of Patent:** **\*\* Sep. 22, 2009**

(54) **ELECTRONIC CAMERA**

(57) **CLAIM**

(75) Inventor: **Young Soo Kim**, Bellevue, WA (US)

The ornamental design for an electronic camera, as shown and described.

(73) Assignee: **Microsoft Corporation**, Redmond, WA (US)

**DESCRIPTION**

(\*\*) Term: **14 Years**

FIG. 1 is a front perspective view of an electronic camera showing my new design;

(21) Appl. No.: **29/304,698**

FIG. 2 is a front view thereof;

(22) Filed: **Mar. 6, 2008**

FIG. 3 is a left side view thereof;

(51) **LOC (9) Cl.** ..... **16-01**

FIG. 4 is a right side view thereof;

(52) **U.S. Cl.** ..... **D16/218**

FIG. 5 is a top view thereof;

(58) **Field of Classification Search** ..... D16/200–205, D16/208, 213, 218; 396/29, 535–543; 348/373–376  
See application file for complete search history.

FIG. 6 is a bottom view thereof; and

FIG. 7 is a rear view thereof.

(56) **References Cited**

FIG. 8 is a front perspective view of an electronic camera showing an alternate embodiment of my new design;

**U.S. PATENT DOCUMENTS**

FIG. 9 is a front view thereof;

FIG. 10 is a rear view thereof;

D388,804 S *	1/1998	Swayze et al.	.....	D16/202
D434,057 S *	11/2000	Whitby et al.	.....	D16/202
D479,259 S *	9/2003	Shao et al.	.....	D16/218
D508,511 S *	8/2005	Christou et al.	.....	D16/218
D517,587 S *	3/2006	Eroma et al.	.....	D16/218
D542,820 S *	5/2007	Depay	.....	D16/202
D586,835 S *	2/2009	Koza et al.	.....	D16/212

FIG. 11 is a top view thereof;

FIG. 12 is a bottom view thereof;

FIG. 13 is a right side view thereof; and,

FIG. 14 is a left side view thereof.

\* cited by examiner

The broken lines immediately adjacent to the shaded areas represent the bounds of the claimed design while all other broken lines are for illustrative purposes only; the broken lines form no part of the claimed design.

*Primary Examiner*—Ian Simmons

*Assistant Examiner*—Wan Laymon

(74) *Attorney, Agent, or Firm*—Banner & Witcoff, Ltd

**1 Claim, 12 Drawing Sheets**

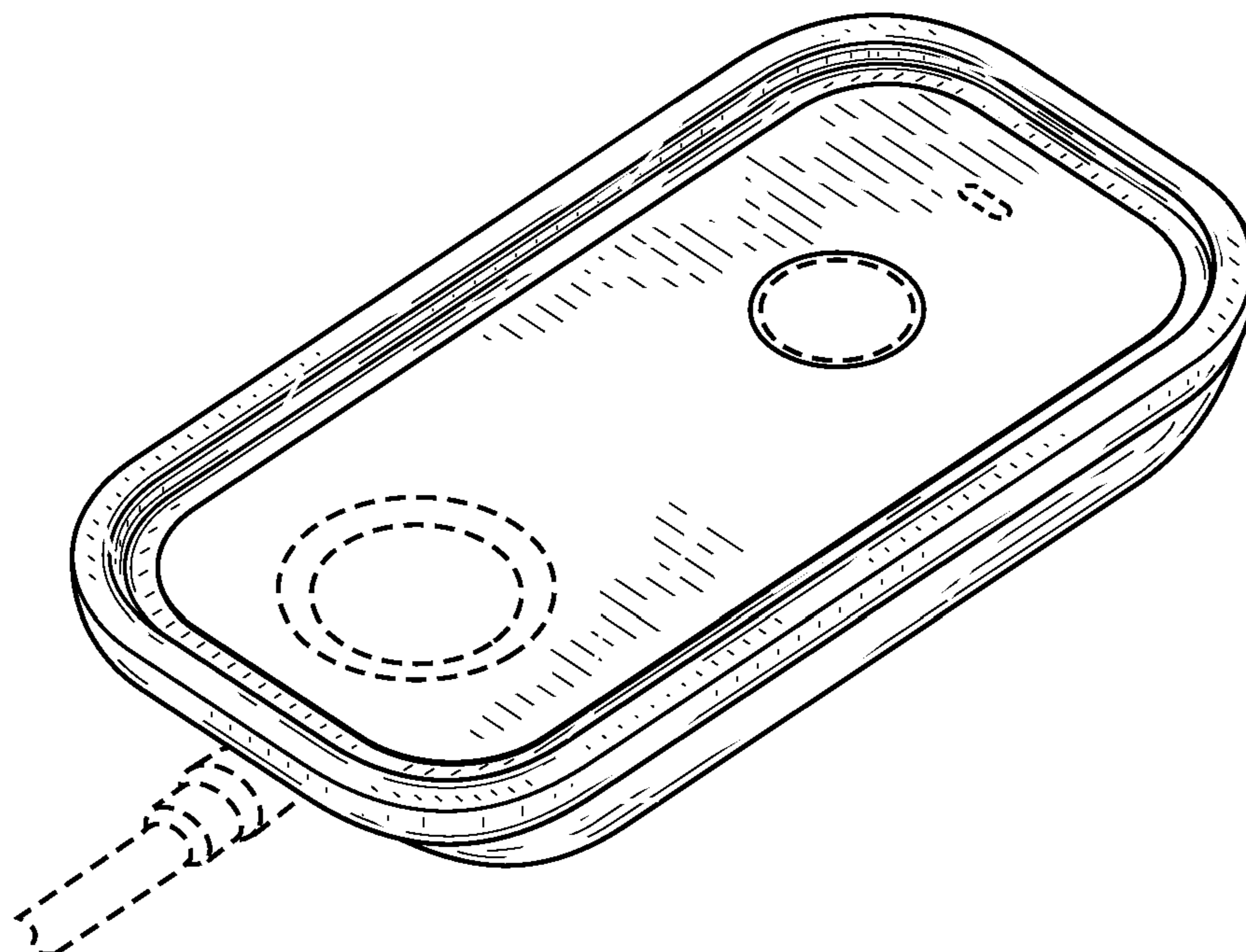

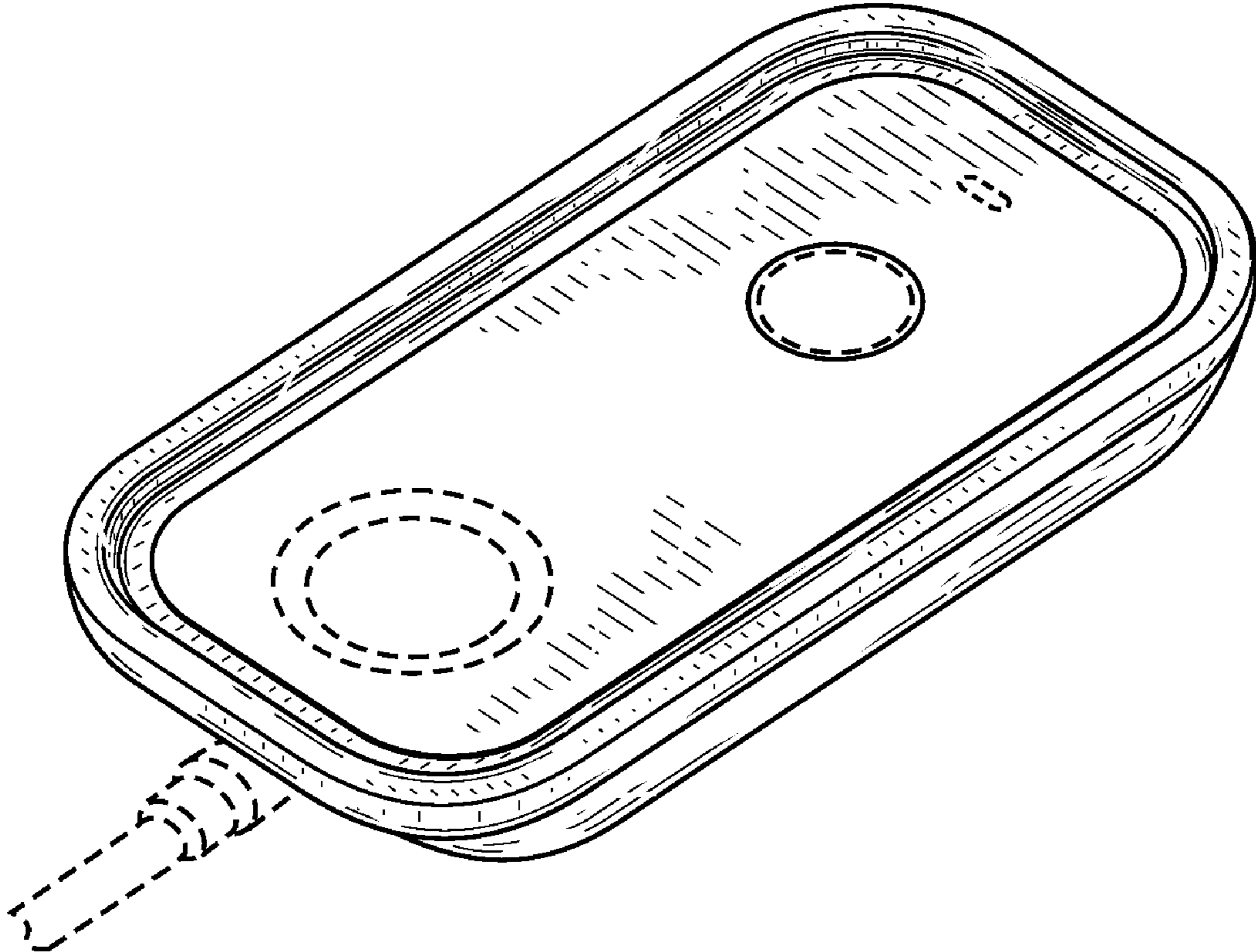

FIG. 1

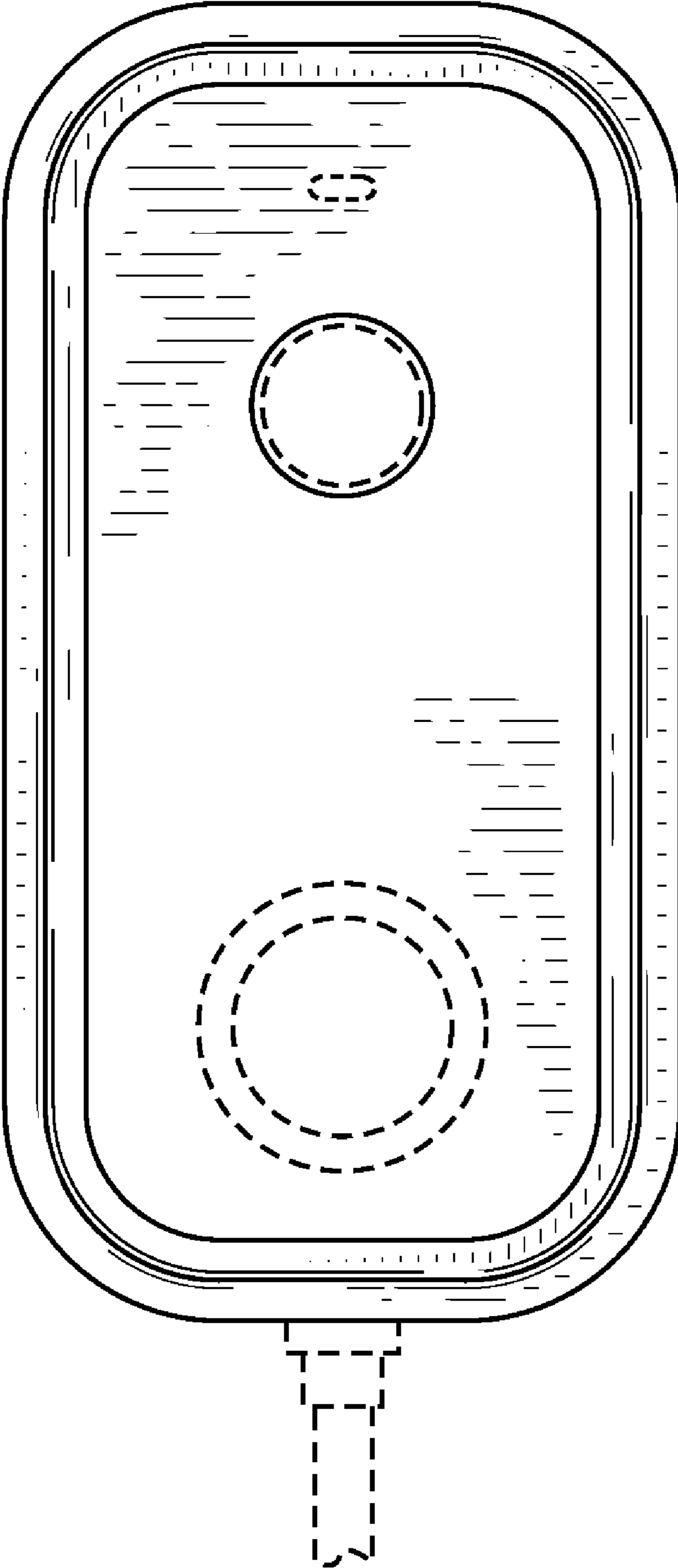

FIG. 2

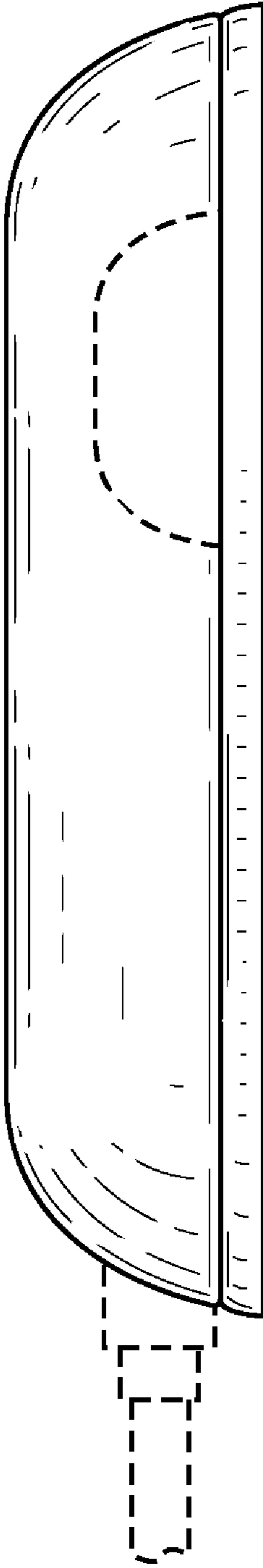

FIG. 3

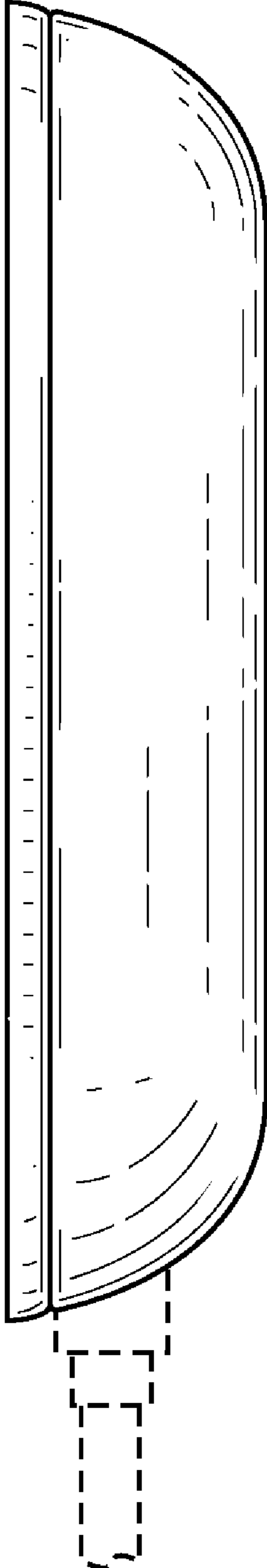

FIG. 4

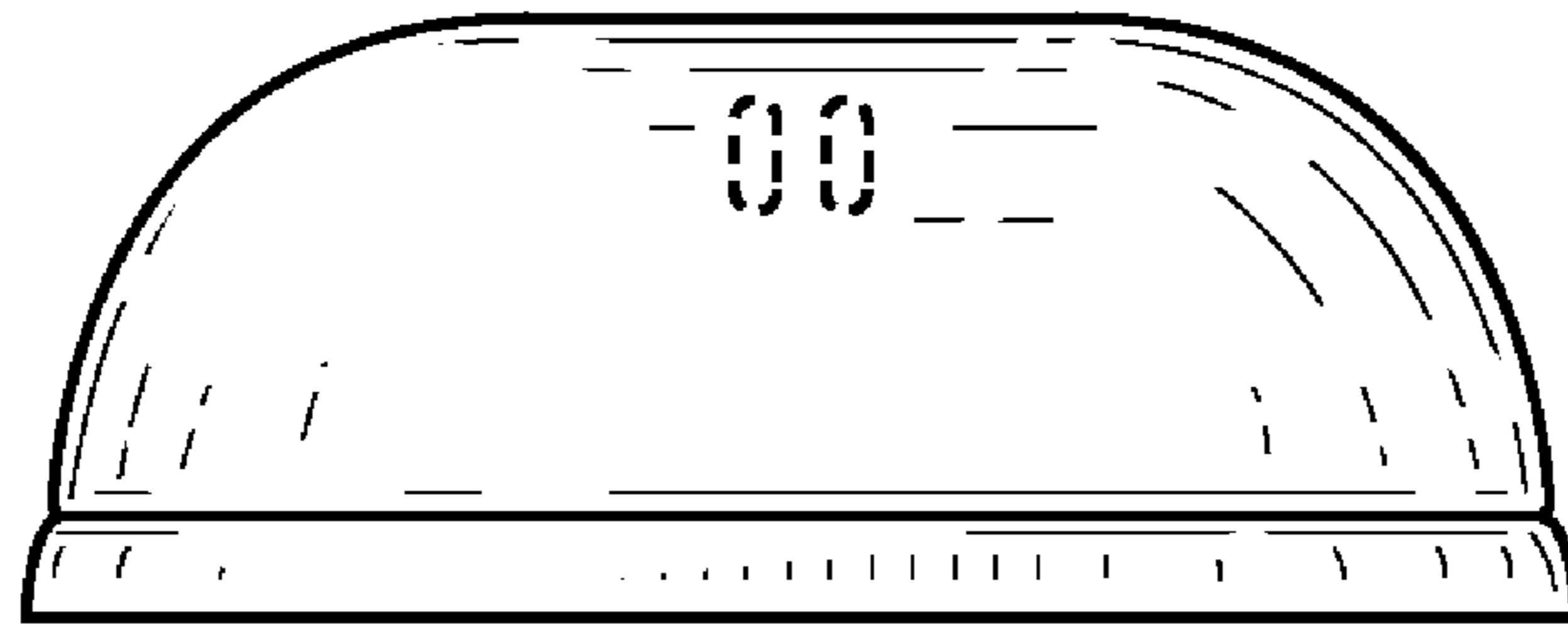

FIG. 5

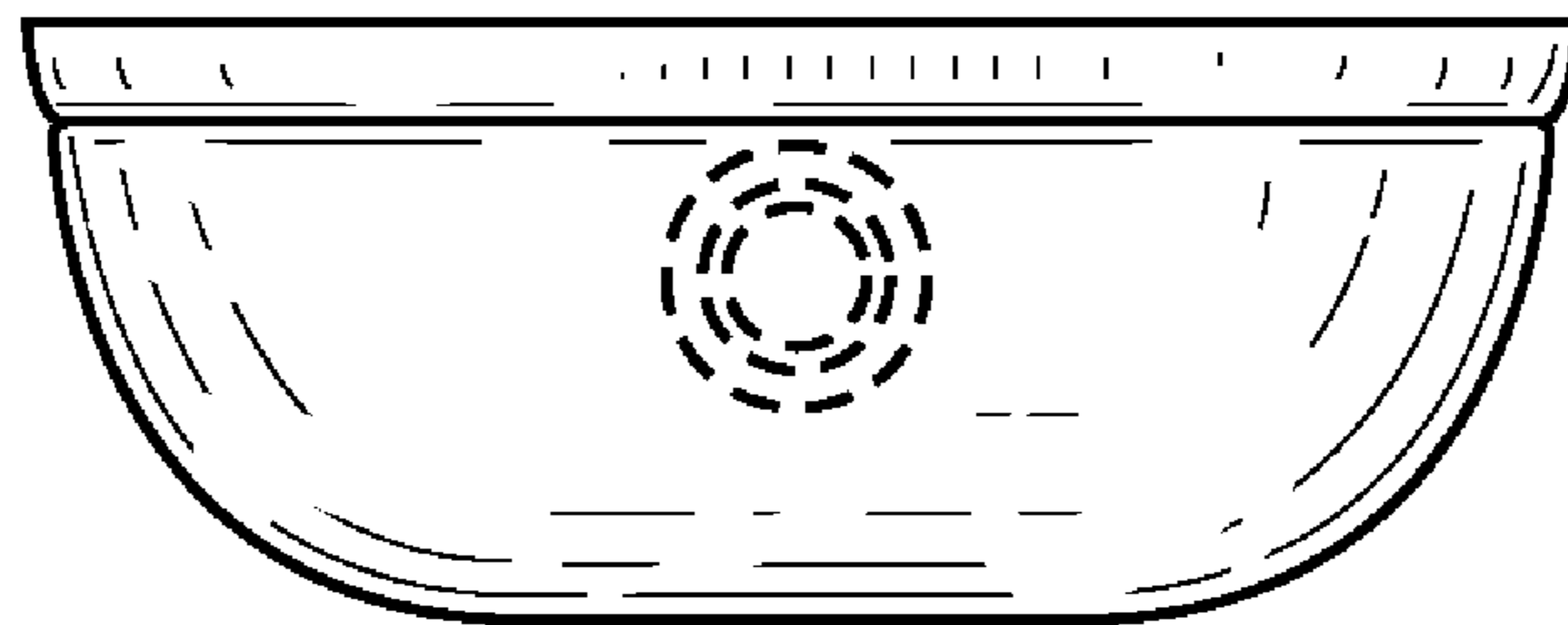

FIG. 6

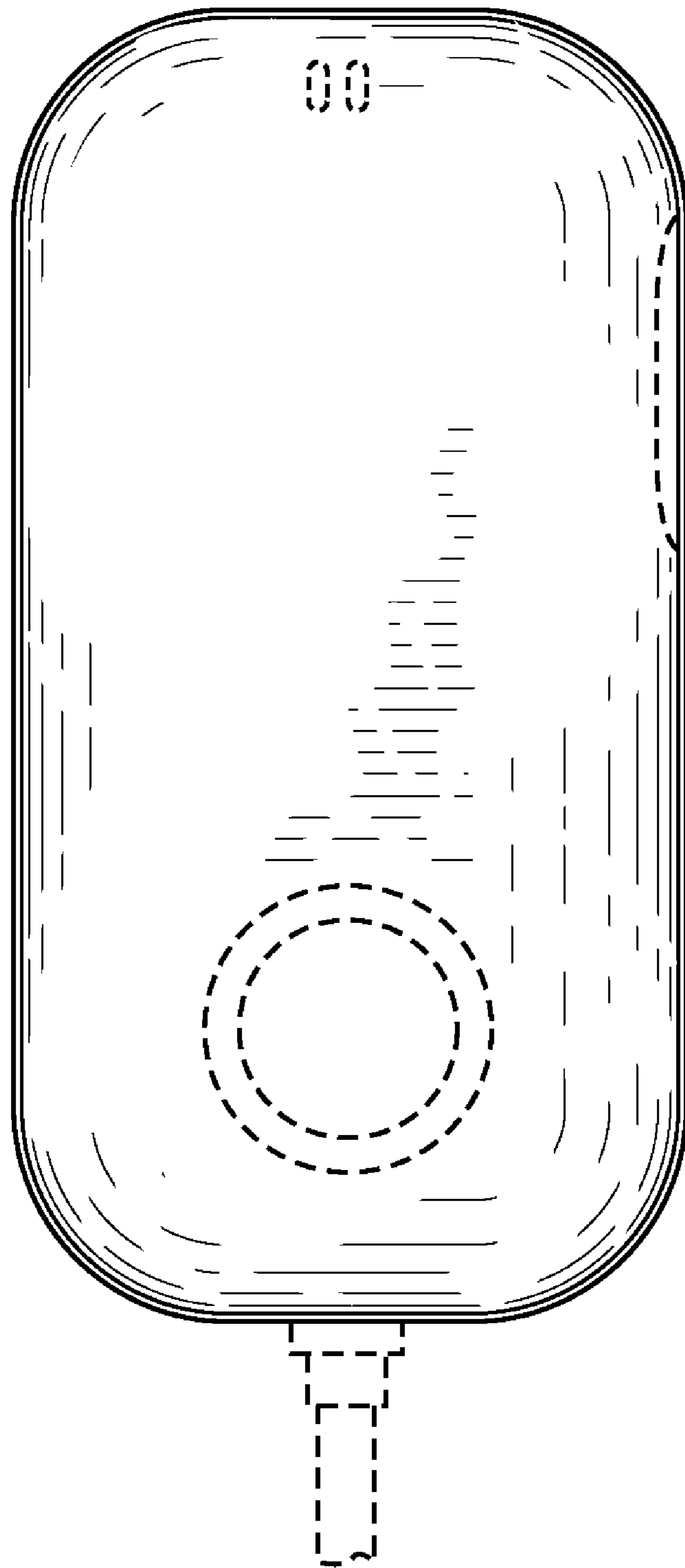

FIG. 7

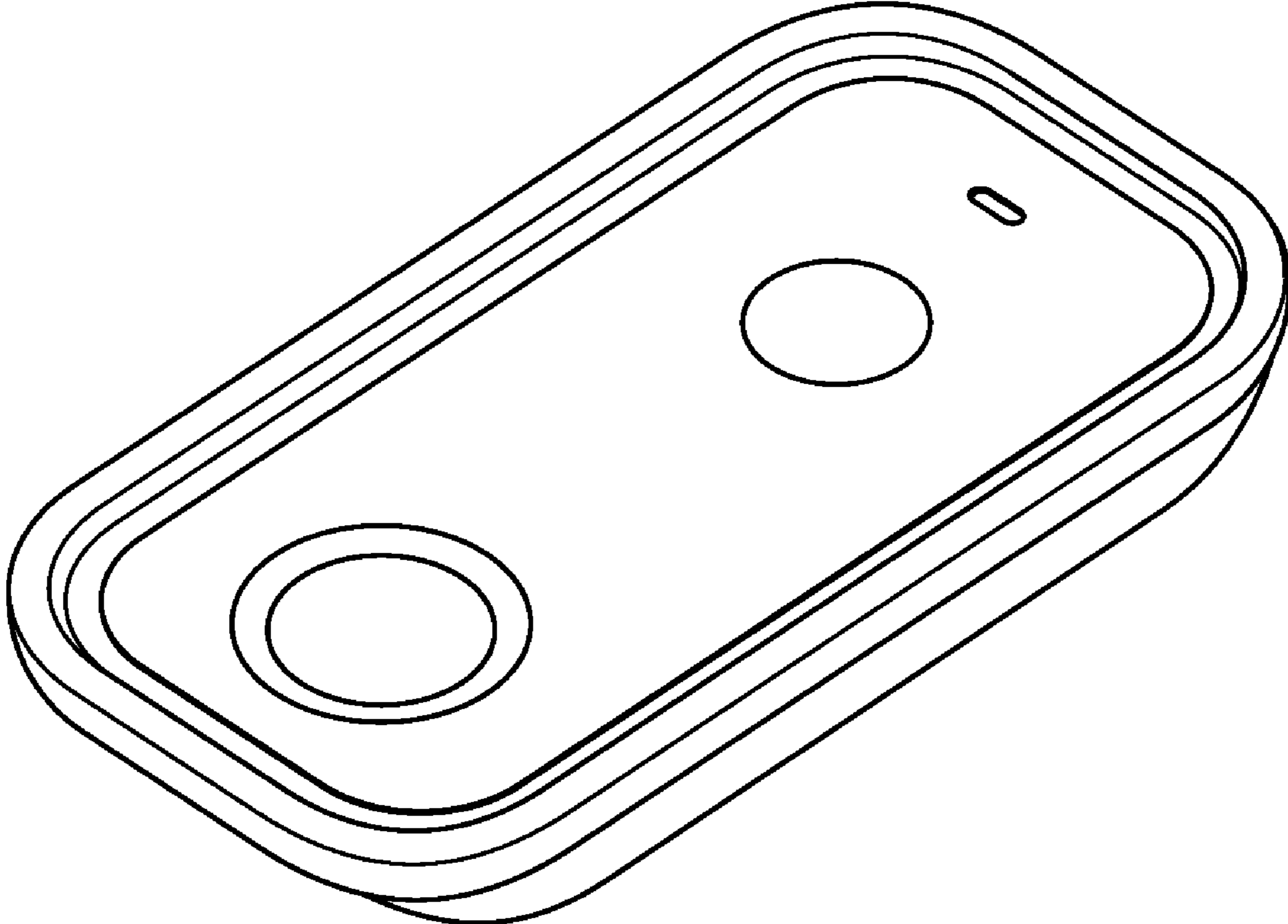

FIG. 8



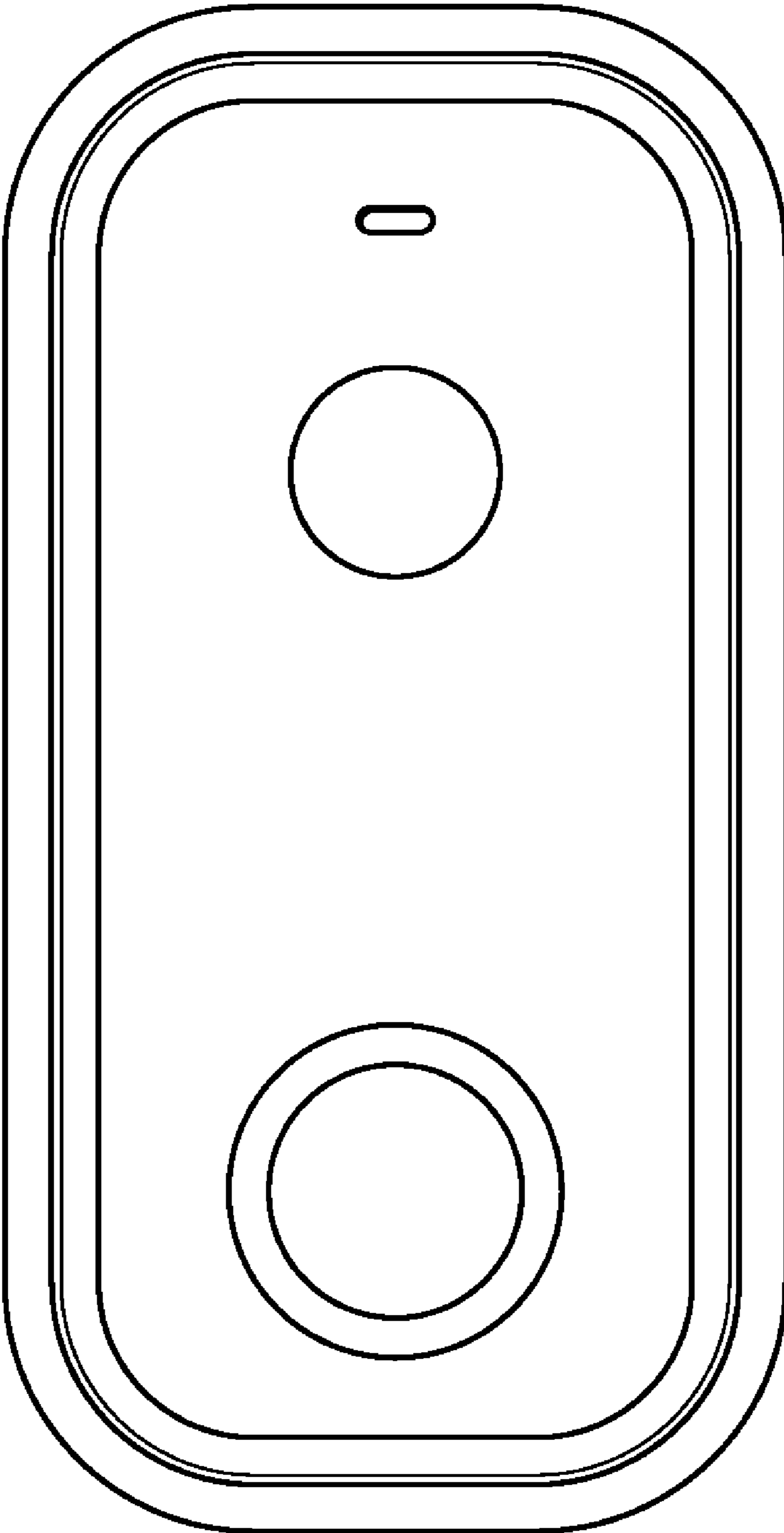

FIG. 9

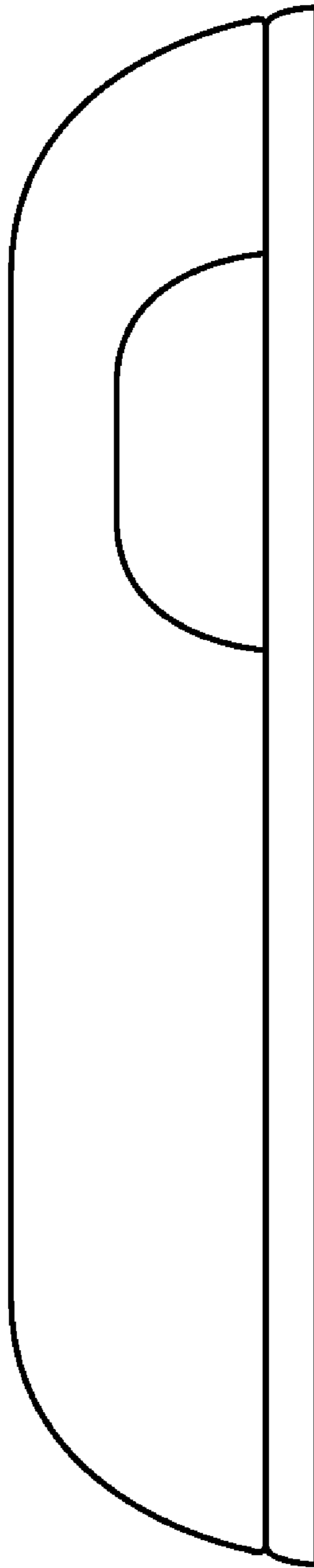

FIG. 10

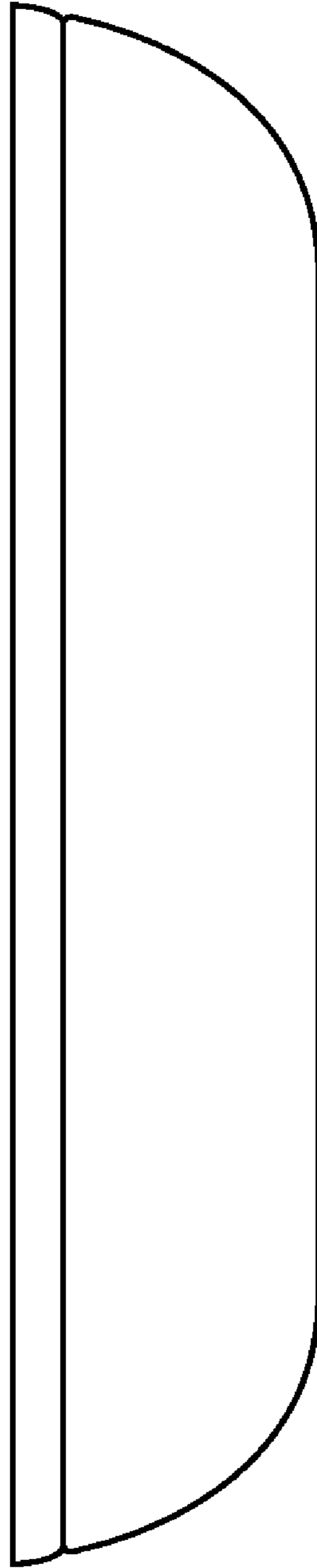

FIG. 11

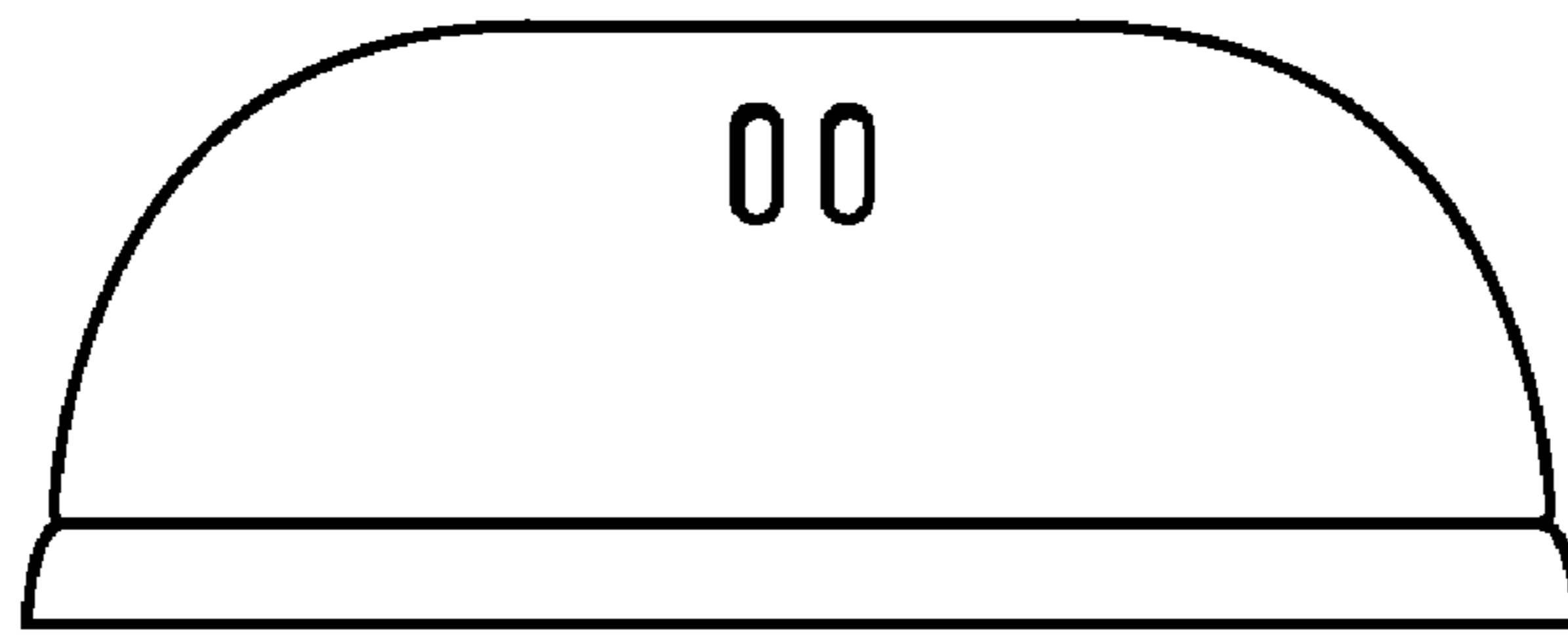

FIG. 12

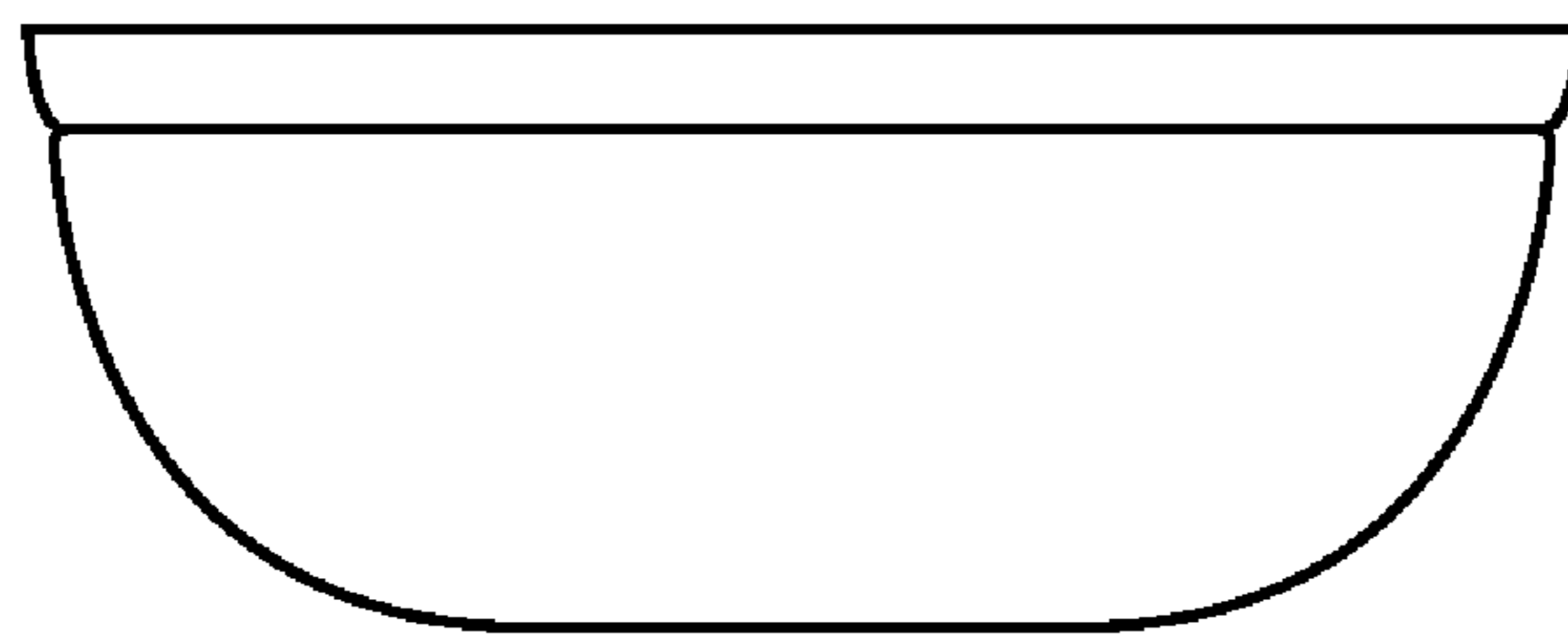

FIG. 13

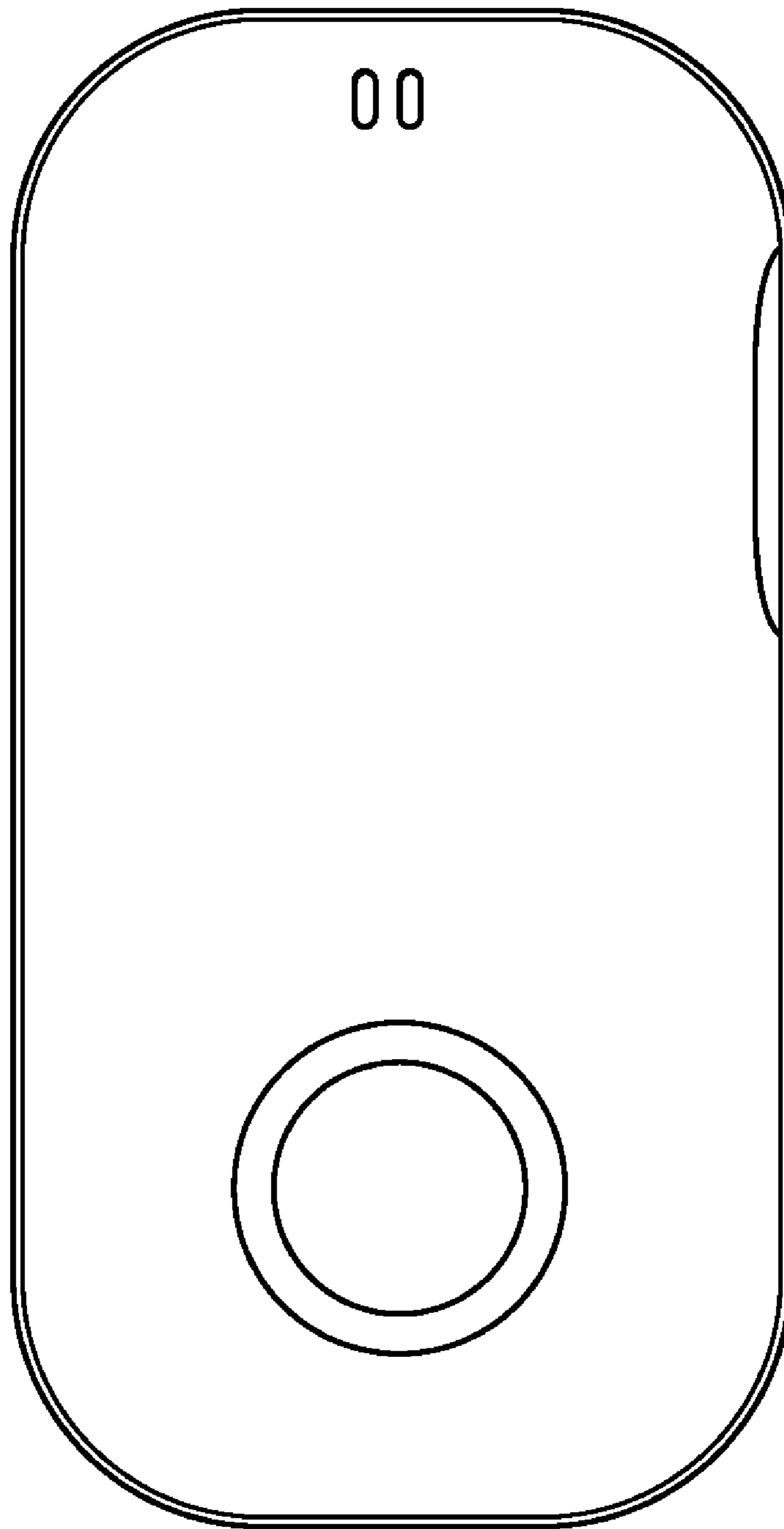

FIG. 14