



US00D600699S

(12) **United States Design Patent**
Johnston et al.

(10) **Patent No.:** **US D600,699 S**
(45) **Date of Patent:** **** Sep. 22, 2009**

(54) **SLIP COVER**

(75) Inventors: **John E. Johnston**, Redwood City, CA
(US); **Gregg E. Zehr**, Los Gatos, CA
(US)

(73) Assignee: **Amazon Technologies, Inc.**, Seattle, WA
(US)

(**) Term: **14 Years**

(21) Appl. No.: **29/248,905**

(22) Filed: **Sep. 8, 2006**

(51) **LOC (9) Cl.** **14-02**

(52) **U.S. Cl.** **D14/440**

(58) **Field of Classification Search** D14/439,
D14/440, 345, 341–344, 346, 371, 125–129,
D14/327; 206/320, 576, 305, 215, 232, 524,
206/425, 472, 224, 312, 387.13, 307, 387.1,
206/756; D3/286, 283, 295, 273, 303, 247,
D3/215, 245, 232, 900, 249, 201, 276, 294,
D3/301; 224/929; 708/110; 190/109, 100,
190/119, 901; 362/683, 725, 681, 686, 679;
229/87.5, 67.1, 800; 220/522, 4.23; 345/169,
345/104, 156, 168, 173, 179, 672, 174; 150/147,
150/135; 402/2, 70–78, 500–502; 281/45,
281/38, 31, 29, 19.1, 34; D19/26, 27, 33,
D19/75, 86, 22, 90, 59, 60, 78, 83; D18/7;
383/97, 4, 110; 178/18.03, 18.01; 349/12;
428/332; D6/632, 407; 248/458

See application file for complete search history.

(56) **References Cited**

U.S. PATENT DOCUMENTS

102,237 A * 4/1870 Emerson 402/13
1,983,036 A * 12/1934 Kaufmann 190/109
1,985,521 A * 12/1934 Schell 190/124
D118,191 S * 12/1939 Trussell D19/26
D118,197 S * 12/1939 Trussell D19/26
2,228,457 A * 1/1941 Hoople 281/51
D127,370 S * 5/1941 Froelich D19/22
D135,393 S * 3/1943 Weinger et al. D19/86

2,354,782 A * 8/1944 Stradling et al. 281/16
2,505,743 A * 4/1950 Rose 281/29
2,560,437 A * 7/1951 Guenther et al. 190/119
2,755,837 A * 7/1956 Kosek 383/105
2,803,281 A * 8/1957 Sutton 150/138

(Continued)

Primary Examiner—Susan Moon Lee

(74) *Attorney, Agent, or Firm*—Lee & Hayes, PLLC

(57) **CLAIM**

The ornamental design for a slip cover, as shown and described.

DESCRIPTION

FIG. 1 is a perspective view of a slip cover according to one implementation, in a folded condition;

FIG. 2 is a top plan view of the slip cover of FIG. 1;

FIG. 3 is a front elevation view of the slip cover of FIG. 1;

FIG. 4 is a back elevation view of the slip cover of FIG. 1;

FIG. 5 is a bottom plan view of the slip cover of FIG. 1;

FIG. 6 is a left side elevation view of the slip cover of FIG. 1;

FIG. 7 is a right side elevation view of the slip cover of FIG. 1;

FIG. 8 is a perspective view of a slip cover according to another implementation, in a folded condition;

FIG. 9 is a top plan view of the slip cover of FIG. 8;

FIG. 10 is a front elevation view of the slip cover of FIG. 8;

FIG. 11 is a back elevation view of the slip cover of FIG. 8;

FIG. 12 is a bottom plan view of the slip cover of FIG. 8;

FIG. 13 is a left side elevation view of the slip cover of FIG. 8; and,

FIG. 14 is a right side elevation view of the slip cover of FIG. 8.

The stitching in FIGS. 1–7 forms part of the claimed design.

1 Claim, 6 Drawing Sheets

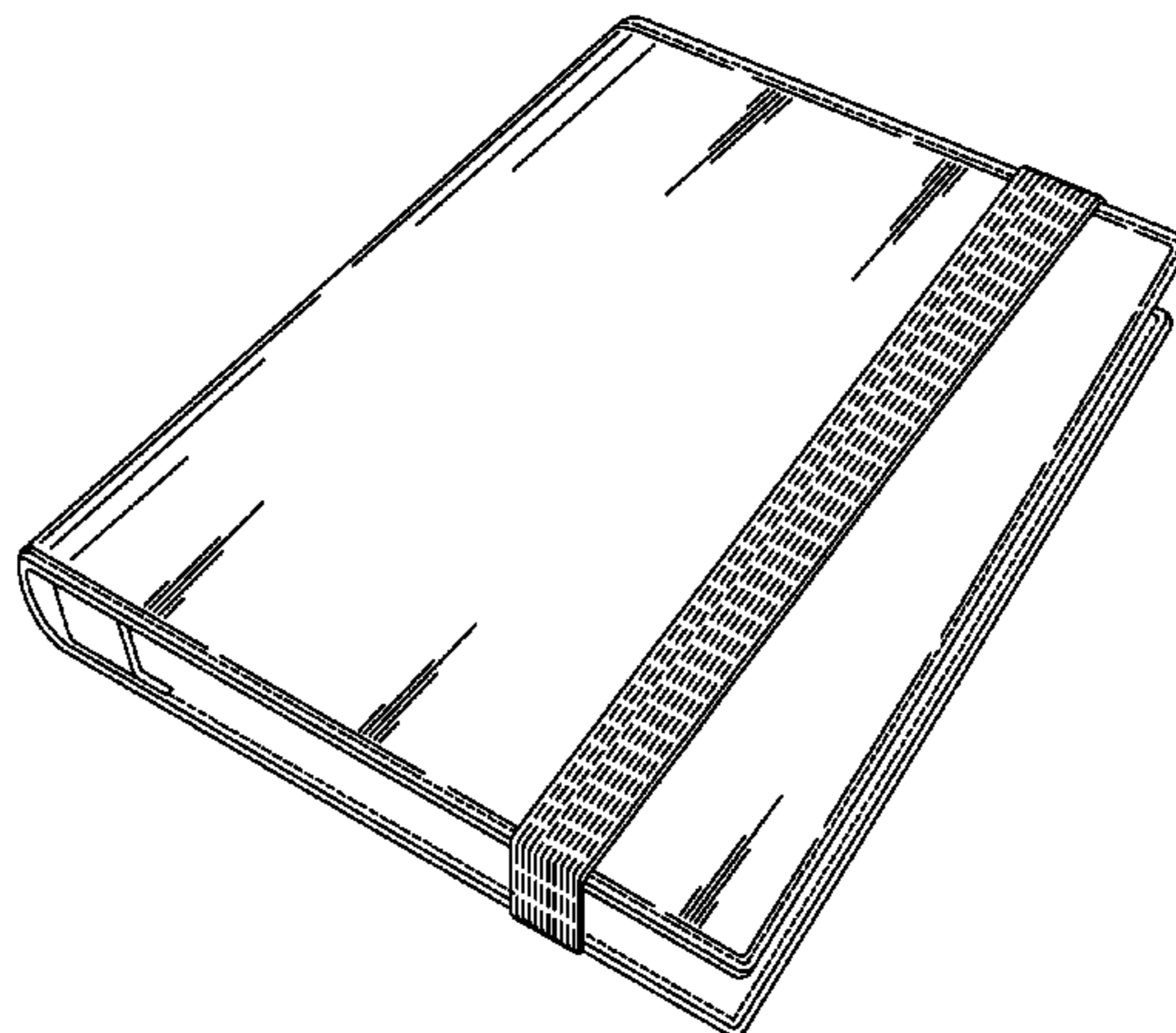

US D600,699 S

U.S. PATENT DOCUMENTS

3,154,125	A *	10/1964	Harvey	229/67.1
3,159,327	A *	12/1964	Feather	281/19.1
3,335,847	A *	8/1967	Murphy et al.	206/574
3,380,644	A *	4/1968	D Alessio	206/424
D223,644	S *	5/1972	Croon	D3/247
D241,381	S *	9/1976	Garnier	D18/7
4,113,394	A *	9/1978	Giulie	402/46
D259,749	S *	7/1981	McDonald	D3/247
D267,290	S *	12/1982	Kurozumi	D3/303
4,407,410	A *	10/1983	Graetz et al.	206/387.13
4,501,361	A *	2/1985	Rose, Jr.	206/493
4,511,034	A *	4/1985	Pan	206/310
D281,056	S *	10/1985	de La Tour	D9/722
D282,377	S *	1/1986	Curran	D19/26
D283,950	S *	5/1986	Markowitz	D3/247
4,641,750	A *	2/1987	Johnson et al.	206/387.13
D291,209	S *	8/1987	Nava	D19/26
4,718,550	A *	1/1988	Johnson	206/387.13
4,724,957	A *	2/1988	Burgschweiger	206/308.1
D300,227	S *	3/1989	Noguchi	D18/2
4,918,632	A *	4/1990	York	361/680
4,966,283	A *	10/1990	Sykes et al.	206/387.13
4,973,184	A *	11/1990	La Salle	402/70
5,013,068	A *	5/1991	Maldonado	281/31
D318,859	S *	8/1991	Hollis	D14/345
D322,458	S *	12/1991	Wiberg	D19/27
D322,628	S *	12/1991	Young	D19/26
D322,987	S *	1/1992	Testro et al.	D19/26
D324,950	S *	3/1992	Ozeki	D6/631
D325,393	S *	4/1992	Schertz et al.	D19/26
5,105,338	A *	4/1992	Held	361/683
5,145,068	A *	9/1992	Schmitz et al.	206/472
D335,685	S *	5/1993	Chen	D19/26
5,219,437	A *	6/1993	Moor et al.	281/29
D338,455	S *	8/1993	Suge	D14/345
D340,355	S *	10/1993	Little	D3/247
D343,862	S *	2/1994	Wyant	D19/26
D359,507	S *	6/1995	Schmidt	D19/26
D361,782	S *	8/1995	Chung	D19/26
5,445,251	A *	8/1995	Redwood	190/109
D363,922	S *	11/1995	Kobayashi	D14/320
D365,361	S *	12/1995	Smith et al.	D19/26
D369,829	S *	5/1996	Tomita et al.	D19/26
D374,037	S *	9/1996	Wyant et al.	D19/26
D377,049	S *	12/1996	Guyer et al.	D19/27
D378,333	S *	3/1997	Anderson	D6/632
5,607,054	A *	3/1997	Hollingsworth	206/320
D386,522	S *	11/1997	Van Osch	D19/26
D388,118	S *	12/1997	Sato	D19/27
D391,605	S *	3/1998	Wyant	D19/27
D393,905	S *	4/1998	Alvern et al.	D3/303
5,772,028	A *	6/1998	Marsilio et al.	206/387.1
5,901,842	A *	5/1999	Berger	206/232
5,916,280	A *	6/1999	Lantz	70/68
D414,033	S *	9/1999	Rohm	D3/249
5,975,578	A *	11/1999	Mayer	281/37
6,000,543	A *	12/1999	Joyce	206/387.13
D419,186	S *	1/2000	Moor	D19/27
D420,240	S *	2/2000	Sorenson et al.	D6/632
D423,273	S *	4/2000	Sankey et al.	D6/632
D426,262	S *	6/2000	Humphrey	D19/26
D429,497	S *	8/2000	Wyant	D19/26
D435,550	S *	12/2000	Chu et al.	D14/345
D437,612	S *	2/2001	Verdicchio	D19/26
6,229,697	B1 *	5/2001	Selker	361/683
D445,408	S *	7/2001	Hwang	D14/132
6,267,236	B1 *	7/2001	Seok	206/320
6,301,098	B1 *	10/2001	Kim	361/680
6,307,741	B1 *	10/2001	Karidis et al.	361/683
D451,133	S *	11/2001	Moor	D19/26
D462,518	S *	9/2002	Truffier-Blanc et al.	D3/273
D465,087	S *	11/2002	Shapiro	D3/303
D466,356	S *	12/2002	Marsilio	D6/632
D471,008	S *	3/2003	Dubone	D3/247
D472,420	S *	4/2003	Marsilio et al.	D6/634
D475,709	S *	6/2003	Tritschler et al.	D14/396
D477,143	S *	7/2003	Nagata et al.	D3/294
D478,623	S *	8/2003	Wilburn	D19/26
D481,251	S *	10/2003	Yau	D6/632
6,646,672	B2 *	11/2003	Feierbach	348/14.02
D483,980	S *	12/2003	Wynalda et al.	D6/632
6,685,022	B2 *	2/2004	Sullivan	206/472
6,727,894	B1 *	4/2004	Karidis et al.	345/174
D494,001	S *	8/2004	Wynalda et al.	D6/634
6,800,840	B2 *	10/2004	Nakano et al.	250/221
6,802,348	B2 *	10/2004	Vernon et al.	150/111
D502,041	S *	2/2005	Wynalda et al.	D6/632
6,935,497	B1 *	8/2005	Domotor et al.	206/320
6,981,586	B2 *	1/2006	Onmori et al.	206/232
7,104,396	B2 *	9/2006	Marsilio et al.	206/308.1
D544,539	S *	6/2007	Singh	D19/27
D546,878	S *	7/2007	Bharma	D19/26
D579,975	S *	11/2008	Brown	D19/26
D586,851	S *	2/2009	Lapsker	D19/26
2001/0009500	A1 *	7/2001	Selker	361/683
2001/0040561	A1 *	11/2001	Weinzierl et al.	345/169
2002/0070132	A1 *	6/2002	Onmori et al.	206/232
2004/0202858	A1 *	10/2004	Lee	428/332

* cited by examiner

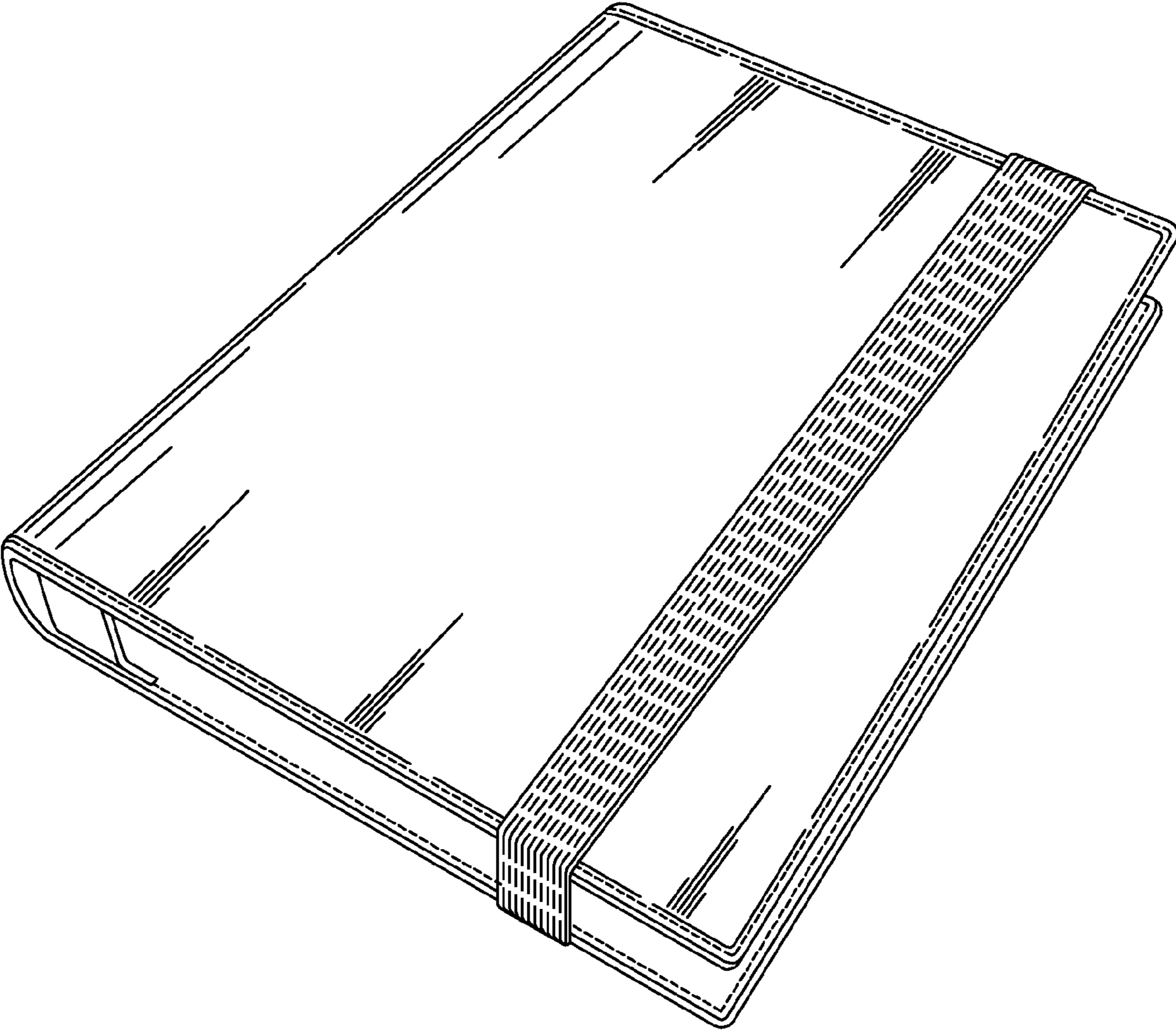

FIG. 1

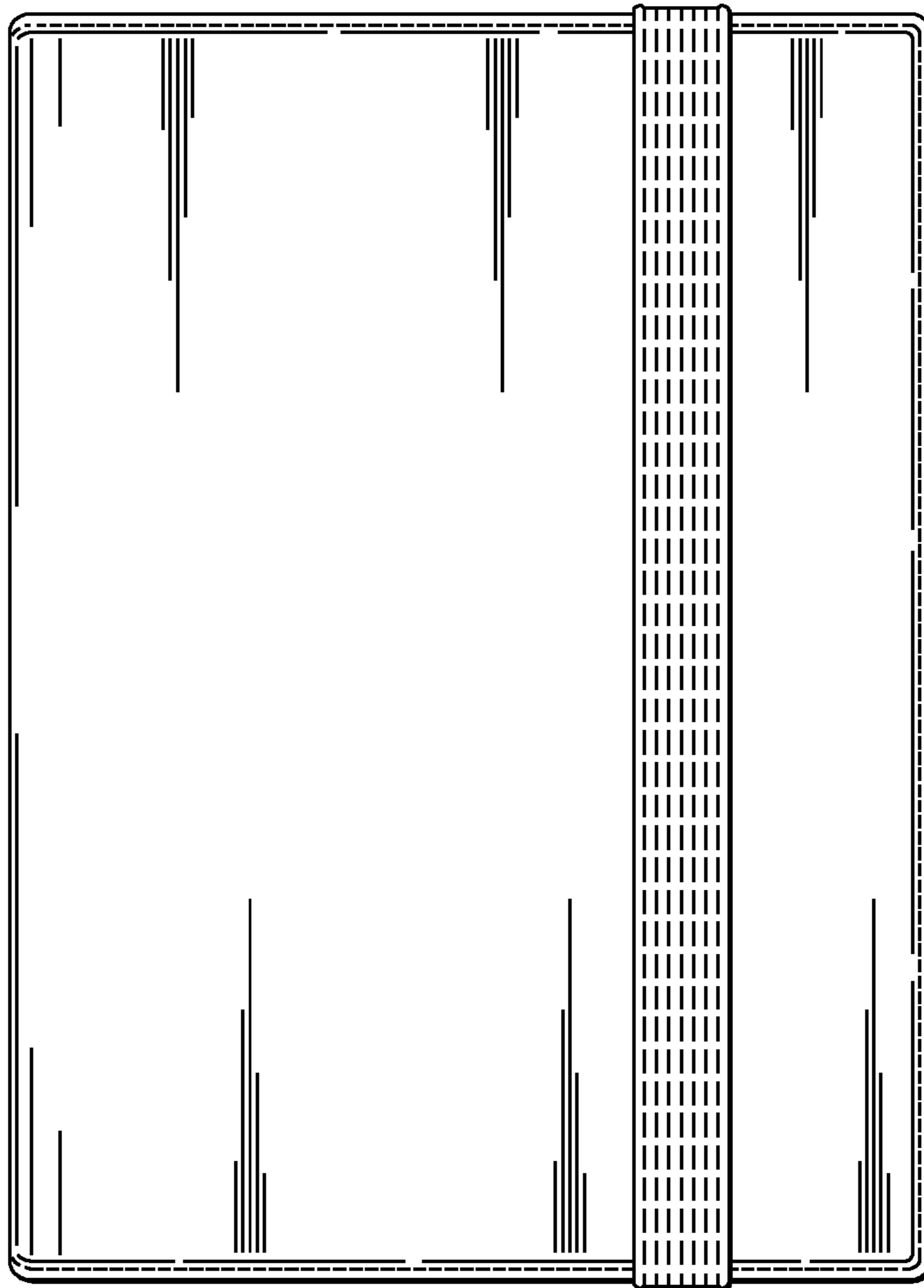

FIG. 2

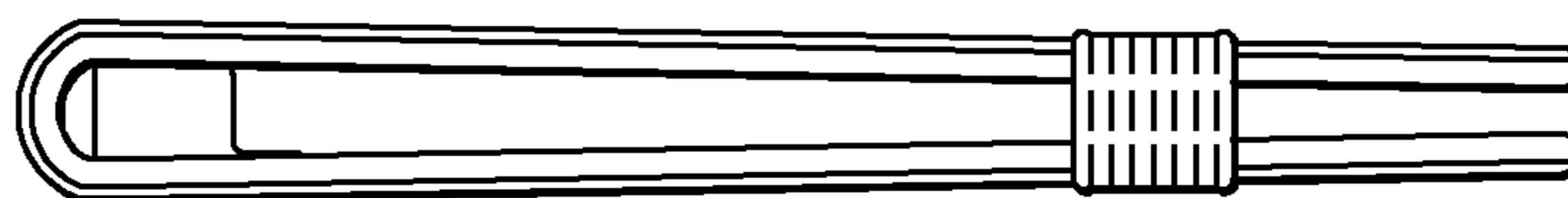

FIG. 3

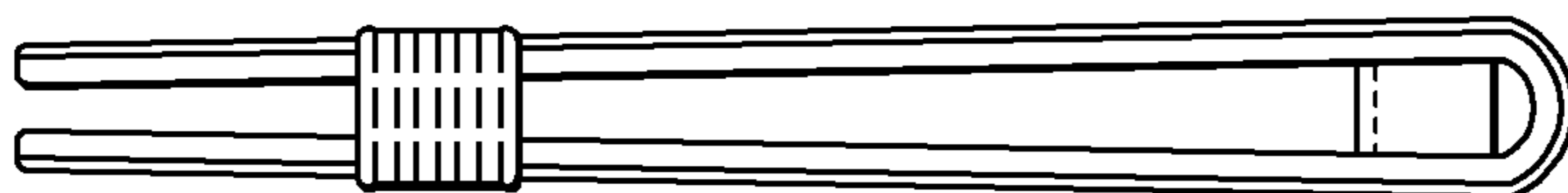

FIG. 4

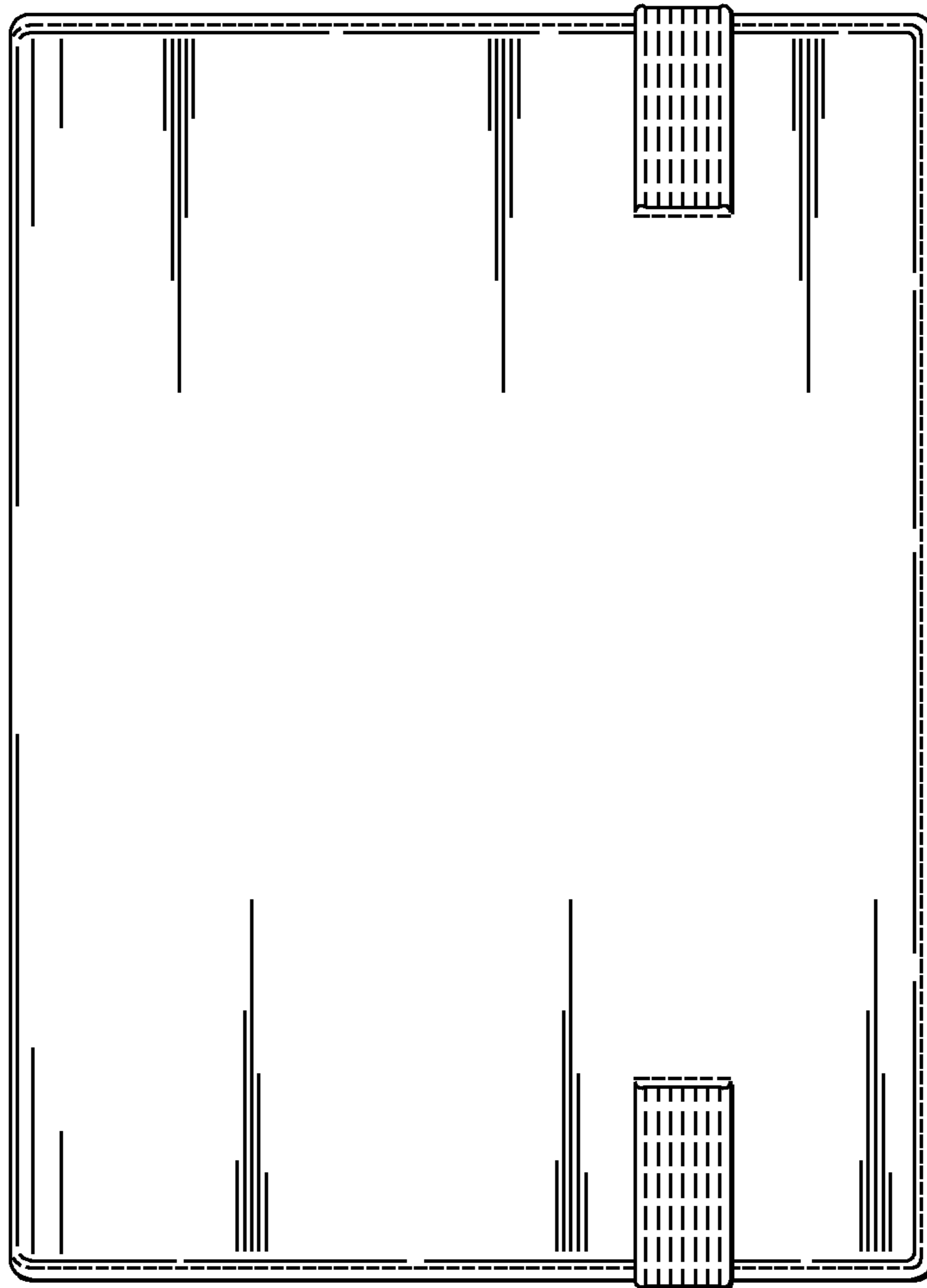

FIG. 5



FIG. 6

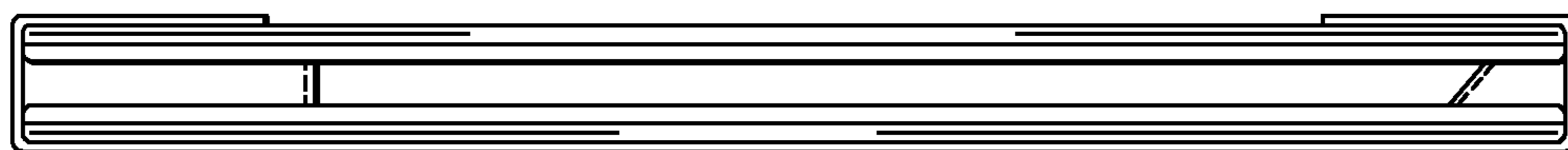

FIG. 7

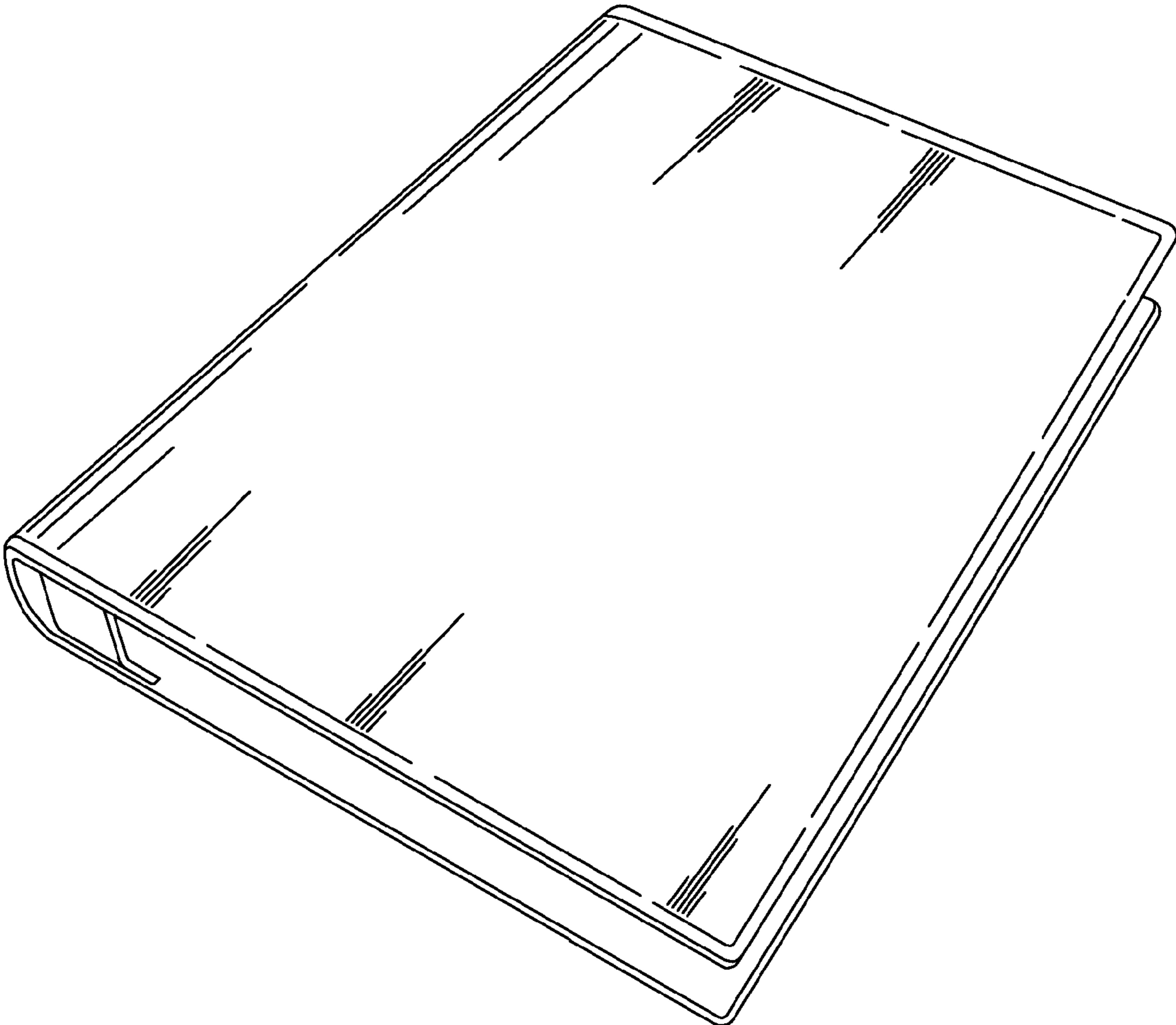

FIG. 8

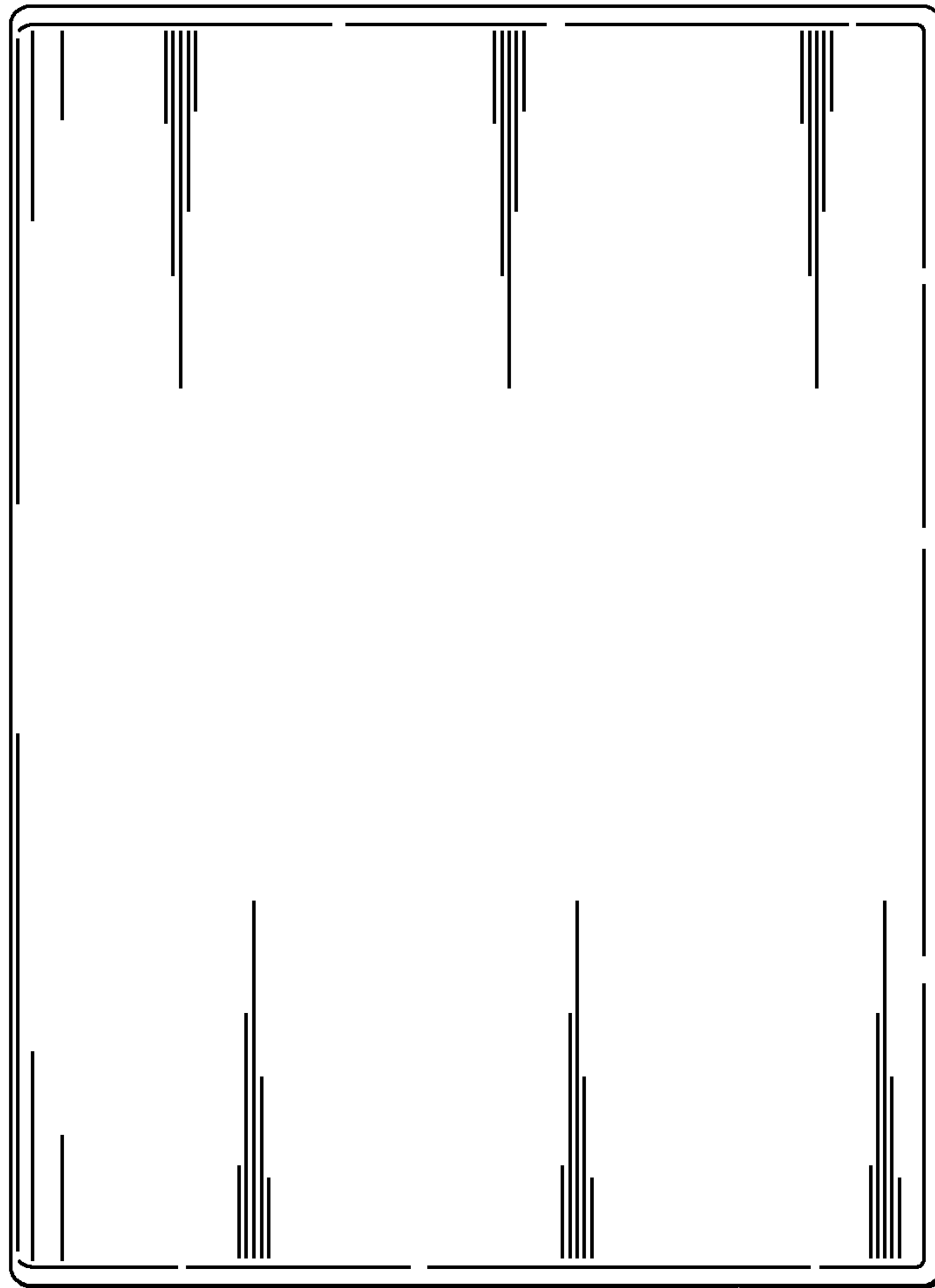

FIG. 9

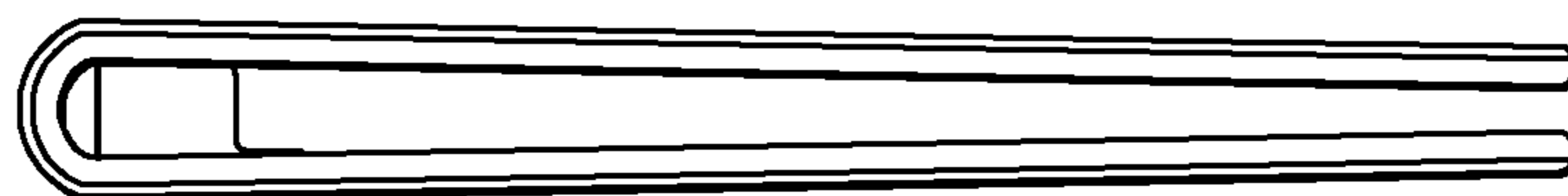

FIG. 10

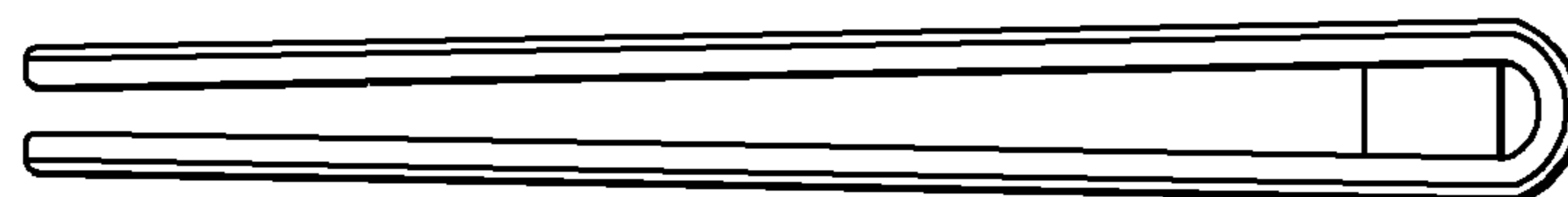

FIG. 11

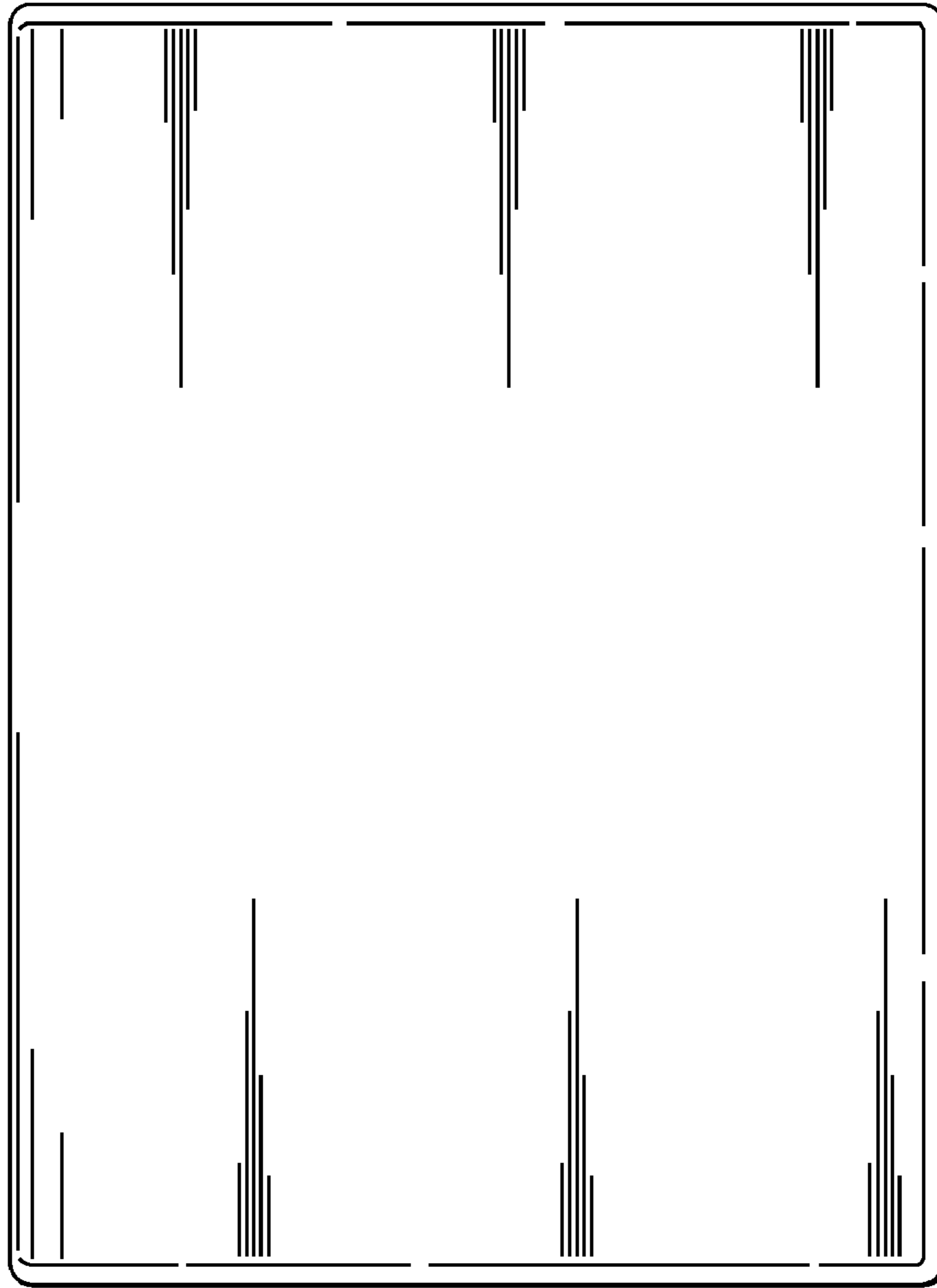

FIG. 12



FIG. 13

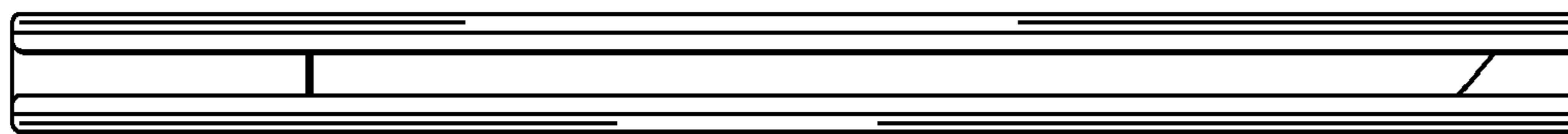

FIG. 14