



US00D600687S

(12) **United States Design Patent**
Smith et al.

(10) **Patent No.:** **US D600,687 S**

(45) **Date of Patent:** **** Sep. 22, 2009**

(54) **PORTABLE INFORMATION HANDLING SYSTEM**

(75) Inventors: **Michael E. Smith**, Austin, TX (US);
Justin Cole Lyles, San Diego, CA (US);
Weijong Sheu, Austin, TX (US)

(73) Assignee: **Dell Products L.P.**, Round Rock, TX (US)

(**) Term: **14 Years**

(21) Appl. No.: **29/324,369**

(22) Filed: **Sep. 11, 2008**

(51) **LOC (9) Cl.** **14-02**

(52) **U.S. Cl.** **D14/315**

(58) **Field of Classification Search** D14/315-322;
D18/1, 2, 7, 11; 235/145 A, 145 R; 341/22,
341/23; 345/104, 156, 168, 169, 173; 361/680-686,
361/679.09, 679.11, 679.27

See application file for complete search history.

(56) **References Cited**

U.S. PATENT DOCUMENTS

5,754,395	A *	5/1998	Hsu et al.	361/679.11
6,067,224	A *	5/2000	Nobuchi	361/679.27
D463,797	S *	10/2002	Andre et al.	D14/327
6,657,854	B2 *	12/2003	Horii et al.	361/679.09
D491,177	S *	6/2004	Andre et al.	D14/318
6,744,623	B2 *	6/2004	Numano et al.	361/679.27
D523,010	S *	6/2006	Paek et al.	D14/327
D523,429	S *	6/2006	Lin	D14/318

D529,907	S *	10/2006	Dong	D14/315
D564,511	S *	3/2008	Akhtar	D14/318
2005/0018396	A1 *	1/2005	Nakajima et al.	361/683
2005/0041378	A1 *	2/2005	Hamada et al.	361/680

* cited by examiner

Primary Examiner—Freda S Nunn

(74) *Attorney, Agent, or Firm*—Hamilton & Terrile, LLP;
Robert W. Holland

(57) **CLAIM**

The ornamental design for a portable information handling system, as shown and described.

DESCRIPTION

FIG. 1 is a front perspective view of the portable information handling system in a closed position comprising the present invention;

FIG. 2 is a front view thereof;

FIG. 3 is a right side view thereof;

FIG. 4 is a left side view thereof;

FIG. 5 is a rear view thereof;

FIG. 6 is a top view thereof;

FIG. 7 is a bottom view thereof; and,

FIG. 8 is a front perspective view of the portable information handling system in an open position.

Broken lines shown in the drawings illustrate portions of the portable information handling system, and form no part of the claimed design.

1 Claim, 5 Drawing Sheets

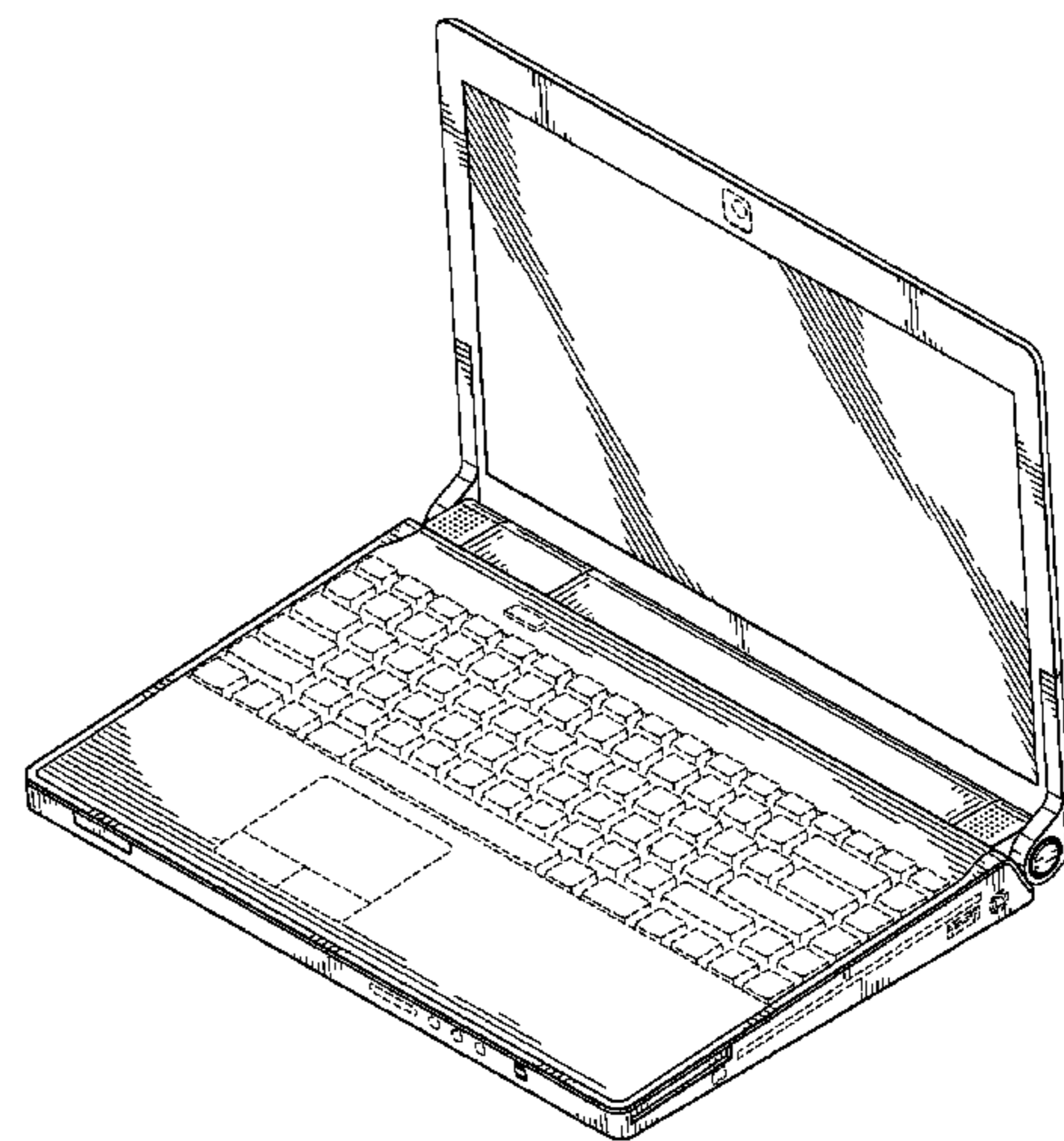
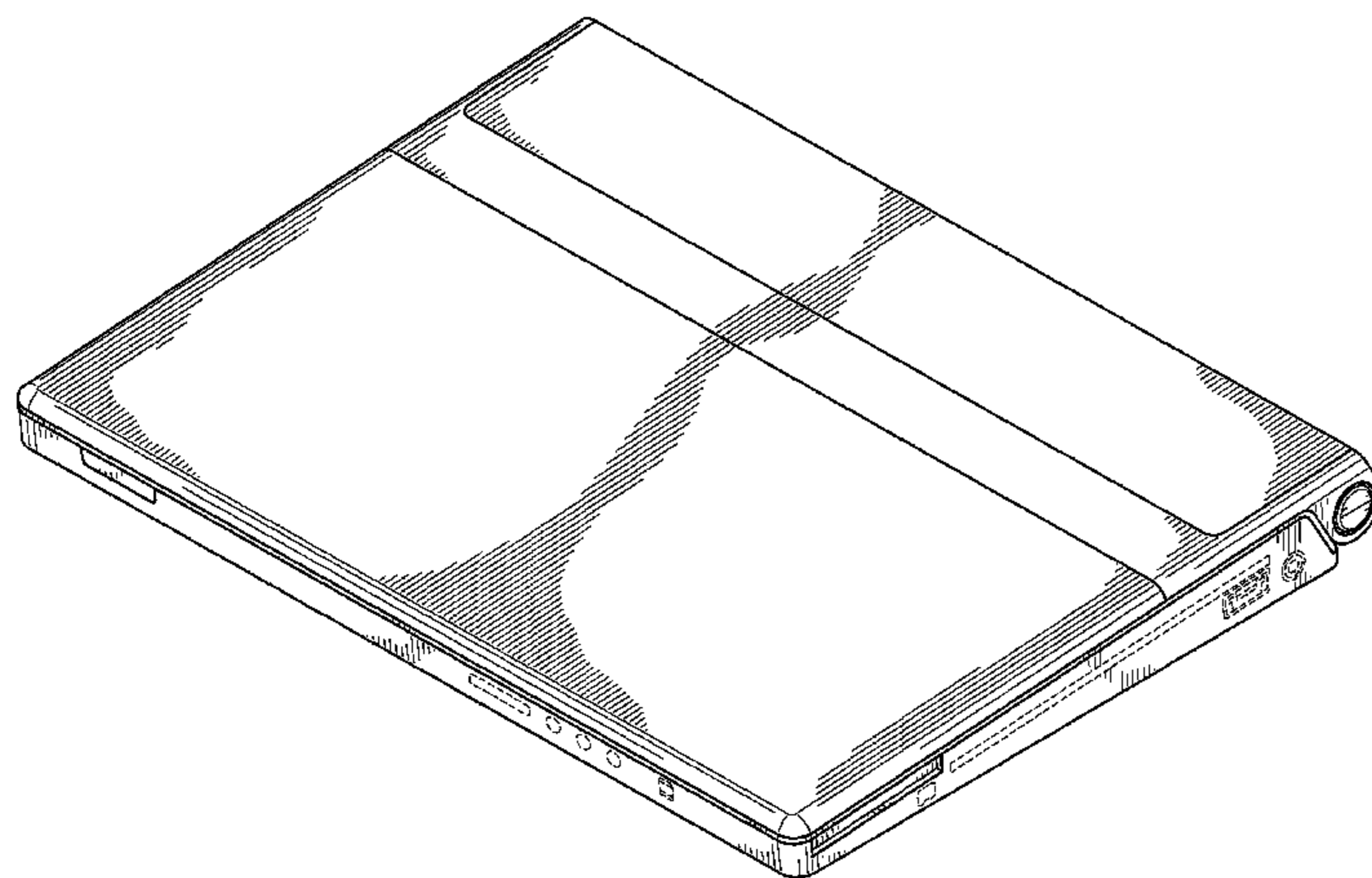

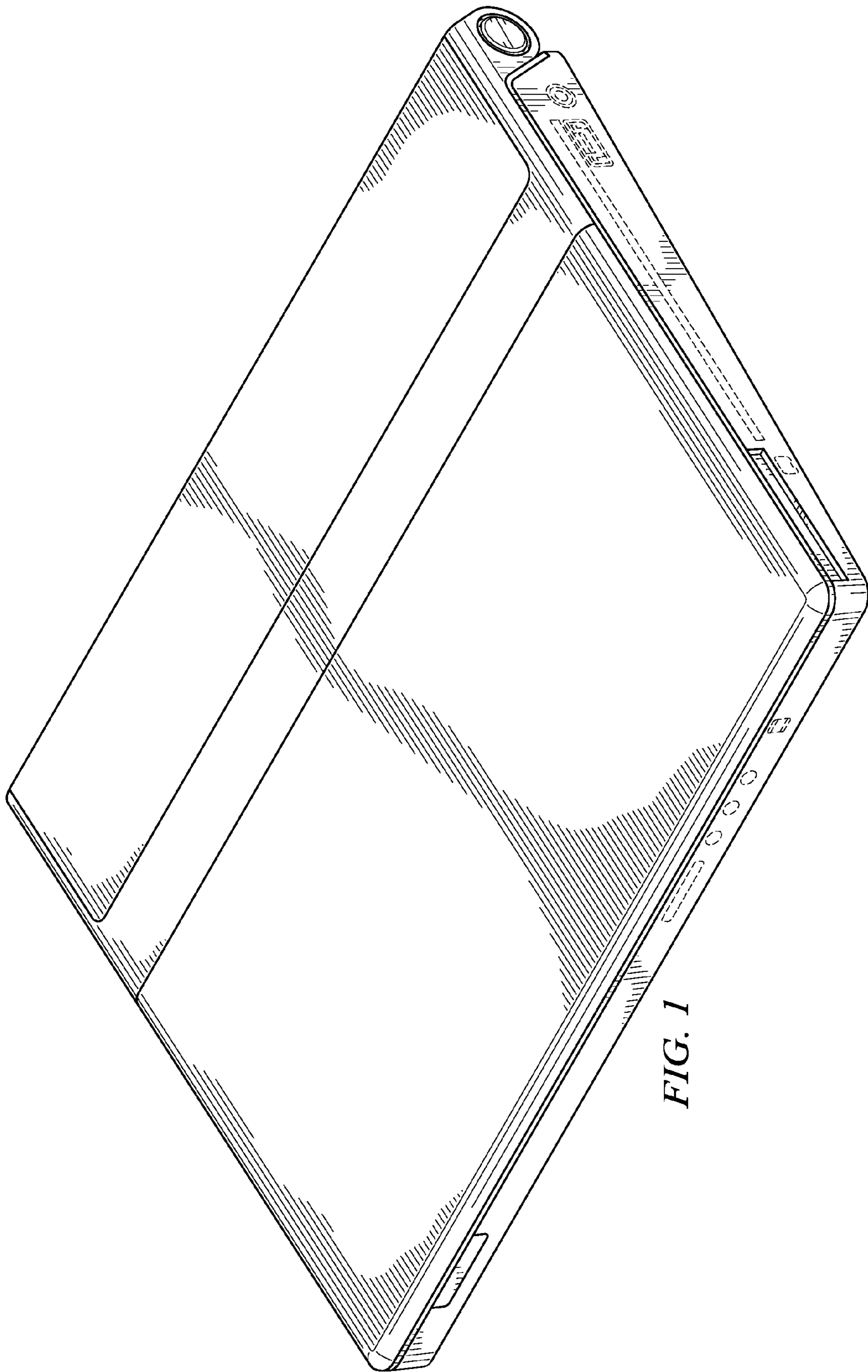

FIG. 1

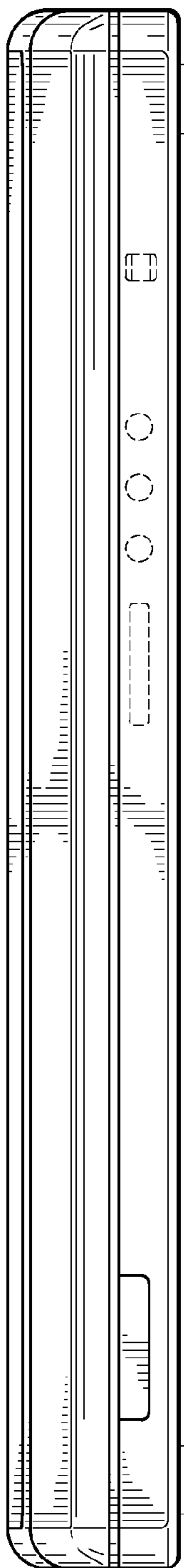

FIG. 2

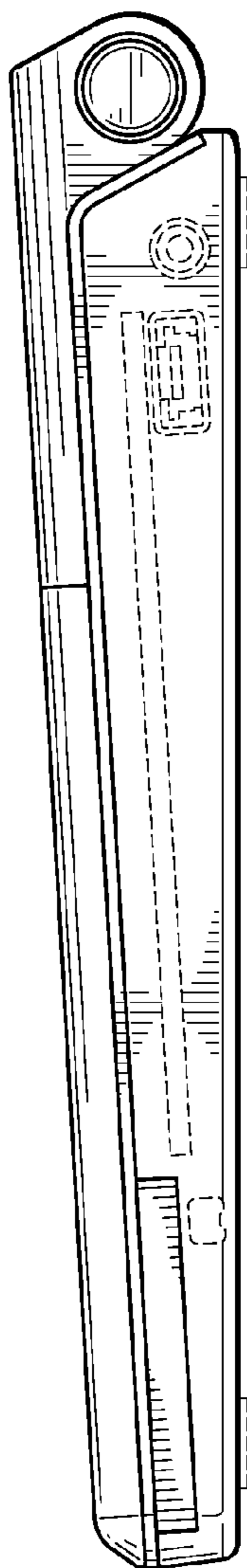

FIG. 3

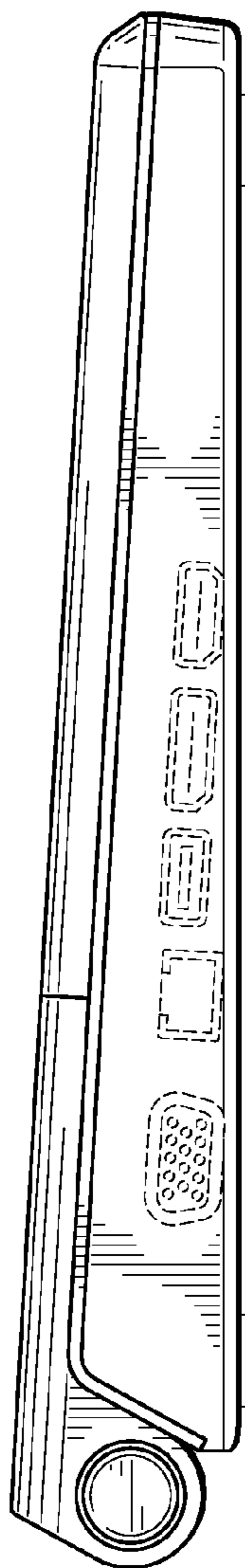

FIG. 4

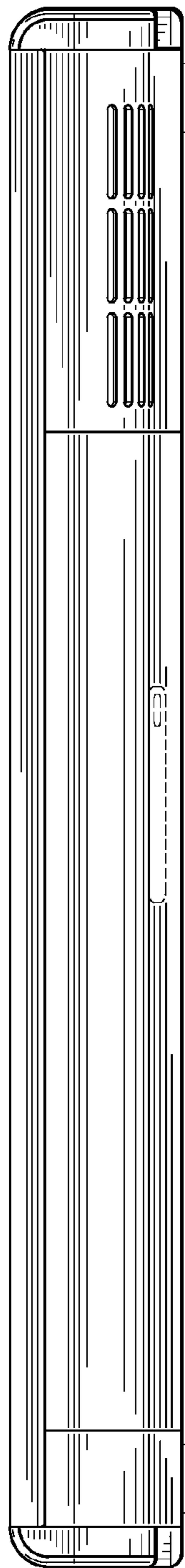

FIG. 5

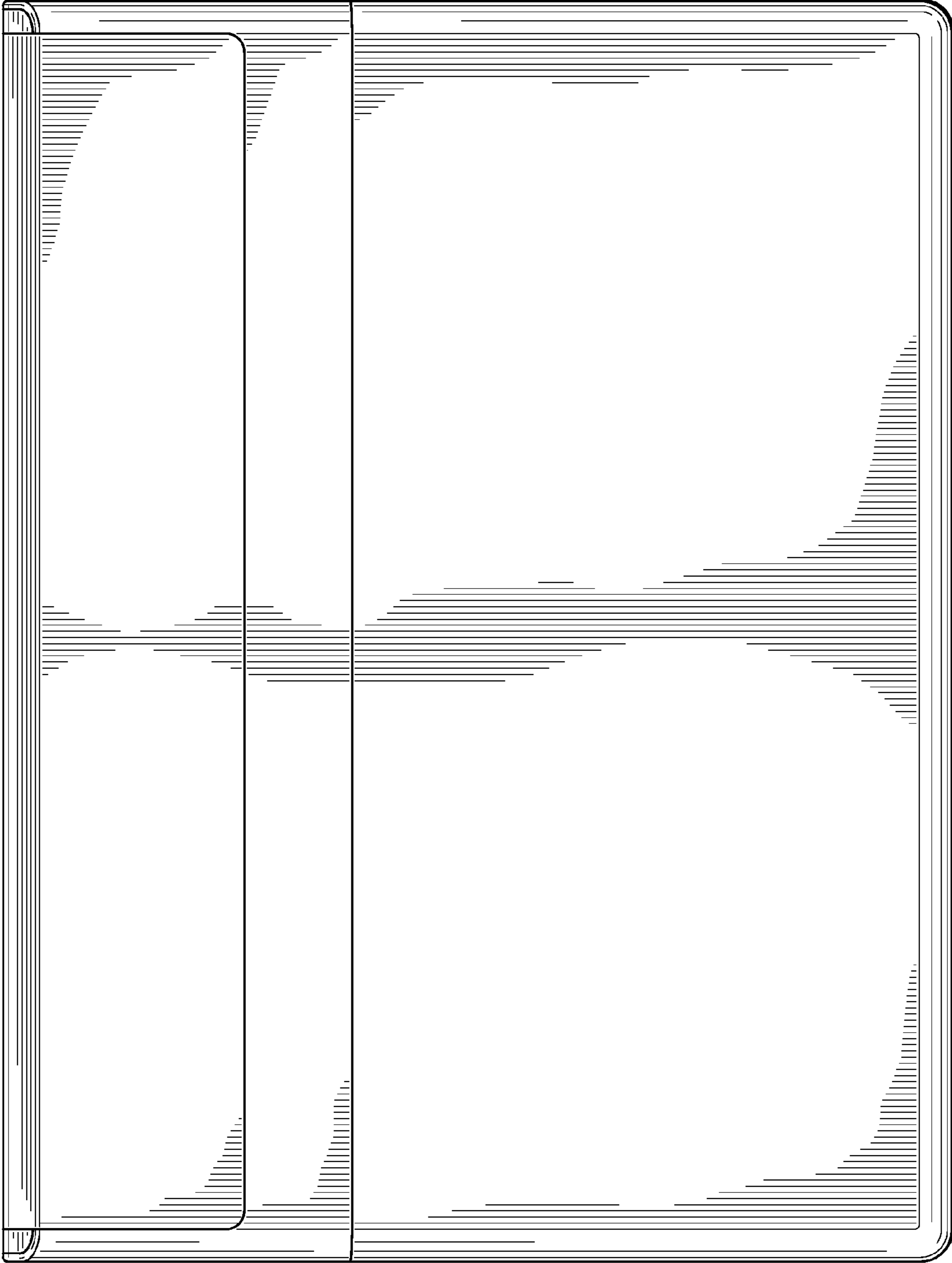

FIG. 6

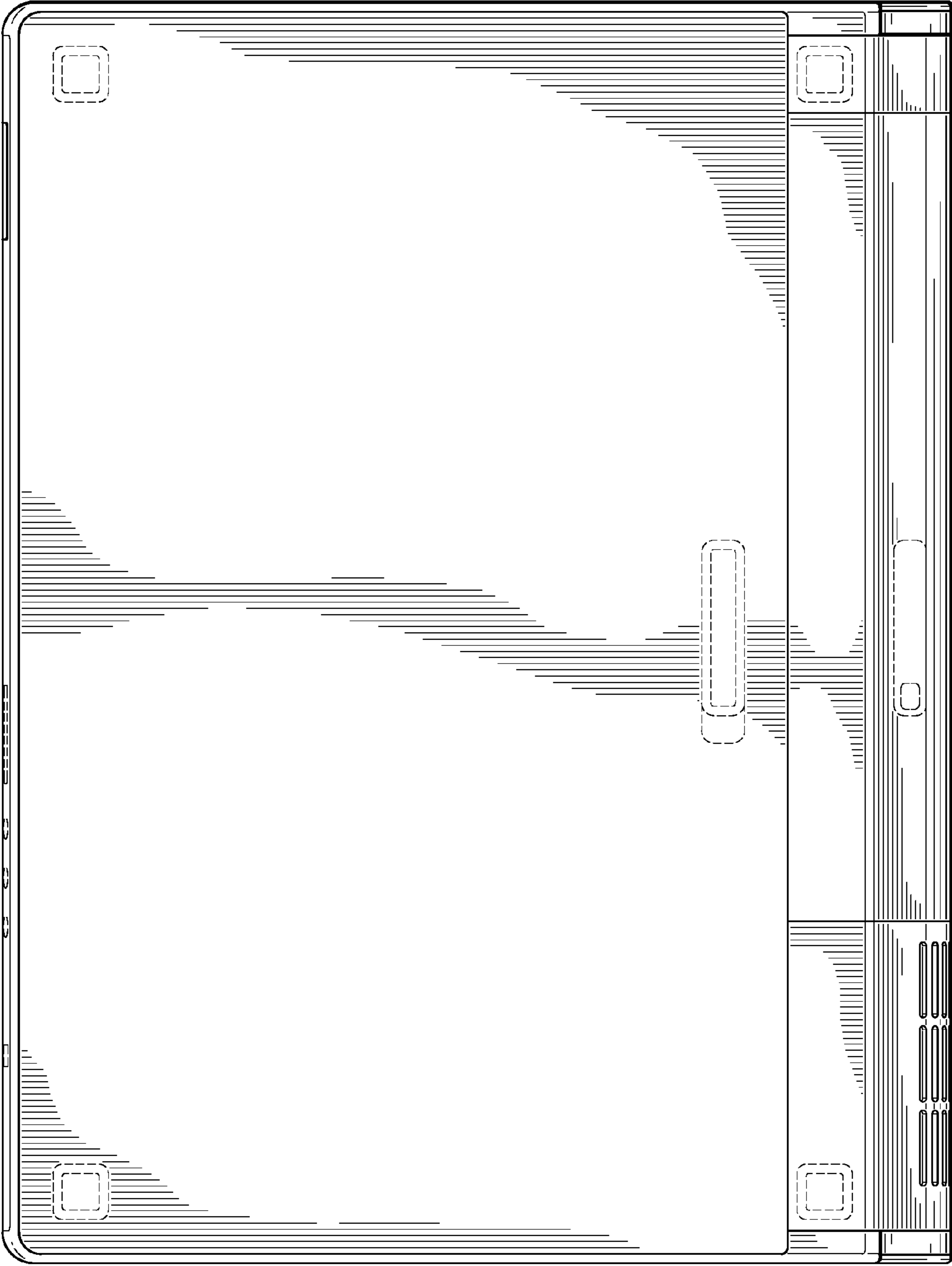

FIG. 7

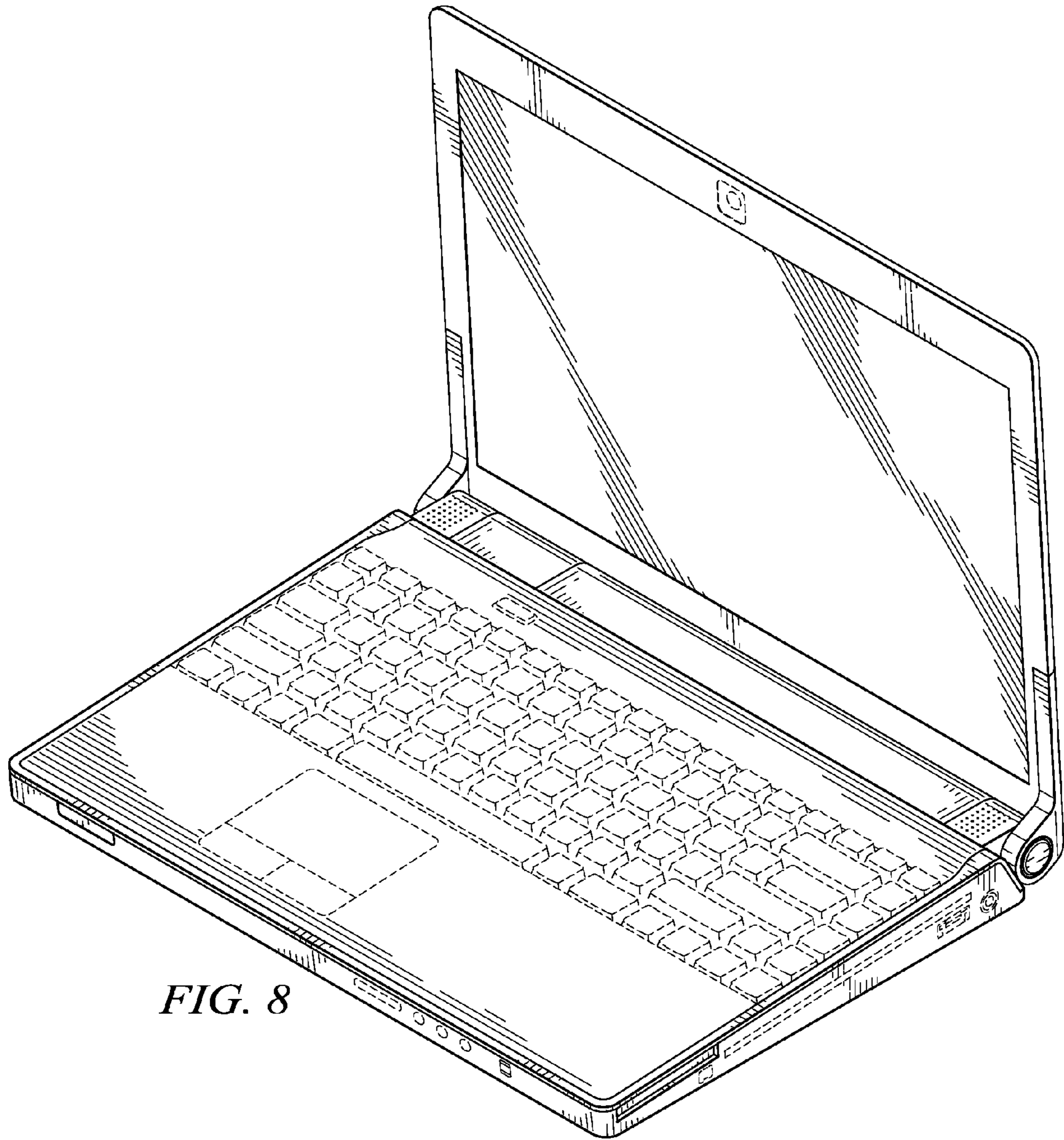

FIG. 8