



US00D600668S

(12) **United States Design Patent**
Lyles

(10) **Patent No.:** **US D600,668 S**

(45) **Date of Patent:** **** Sep. 22, 2009**

(54) **HANDSET**

(75) Inventor: **Justin Lyles**, San Diego, CA (US)

(73) Assignee: **Nokia Corporation**, Espoo (FI)

(**) Term: **14 Years**

(21) Appl. No.: **29/333,400**

(22) Filed: **Mar. 9, 2009**

Related U.S. Application Data

(62) Division of application No. 29/282,162, filed on Jul. 12, 2007, now Pat. No. Des. 588,120.

(51) **LOC (9) Cl.** **14-03**

(52) **U.S. Cl.** **D14/138 AB**

(58) **Field of Classification Search** D14/138 AB,
D14/138 R, 496, 203.1-203.7, 341-347;
455/575.3

See application file for complete search history.

(56) **References Cited**

U.S. PATENT DOCUMENTS

D447,128 S *	8/2001	Lee et al.	D14/138 AB
D488,791 S *	4/2004	Honda et al.	D14/138 AB
D510,923 S *	10/2005	Okamatsu	D14/138 AB
D521,969 S *	5/2006	Kim et al.	D14/138 AB
D536,686 S *	2/2007	Miyata	D14/138 AB
D536,698 S *	2/2007	Fahlgren	D14/247
D537,429 S *	2/2007	Fahlgren	D14/138 AB
D546,310 S *	7/2007	Lee	D14/138 AB
D549,199 S *	8/2007	Sugiura	D14/138 AB
D551,642 S *	9/2007	Kim et al.	D14/138 AB
D554,093 S *	10/2007	Arnholt et al.	D14/138 AB
D559,212 S *	1/2008	Alfthan et al.	D14/138 AB
D559,214 S *	1/2008	Salmi	D14/138 AB
D567,784 S *	4/2008	Lee et al.	D14/138 AB
D568,850 S *	5/2008	Lyles	D14/138 AB
D568,859 S *	5/2008	Choi	D14/138 AB
D570,814 S *	6/2008	Choi et al.	D14/138 AB
D572,690 S *	7/2008	Kim et al.	D14/138 AB
D579,894 S *	11/2008	Yabe et al.	D14/138 R
D579,895 S *	11/2008	Yoshihara et al.	D14/138 R

D582,404 S *	12/2008	Salmi	D14/247
D585,867 S *	2/2009	Lee	D14/138 AB
D588,094 S *	3/2009	Tom	D14/138 AB
D588,095 S *	3/2009	Tom	D14/138 AB
D588,120 S *	3/2009	Lyles	D14/247
D589,927 S *	4/2009	Millora et al.	D14/138 AB

(Continued)

OTHER PUBLICATIONS

Nokia 3610 fold telephone, announced Aug. 2008, [online], [site visited May 5, 2009]. Available from Internet ,<URL: <http://www.gsmarena.com>>.*

(Continued)

Primary Examiner—Jeffrey D Asch

(74) *Attorney, Agent, or Firm*—Banner & Witcoff, Ltd.

(57) **CLAIM**

The ornamental design for a handset, as shown and described.

DESCRIPTION

FIG. 1 is a bottom plan view of a handset showing my new design;

FIG. 2 is a right side view thereof;

FIG. 3 is a front view thereof;

FIG. 4 is a left side view thereof;

FIG. 5 is a top plan view thereof;

FIG. 6 is a rear view thereof;

FIG. 7 is a perspective front view thereof;

FIG. 8 is a perspective rear view thereof;

FIG. 9 is a front view of the handset showing my new design in an alternative open, in-use position;

FIG. 10 is a perspective front view thereof;

FIG. 11 is a rear view thereof;

FIG. 12 is a perspective rear view thereof;

FIG. 13 is a right side view thereof; and,

FIG. 14 is a left side view thereof.

1 Claim, 8 Drawing Sheets

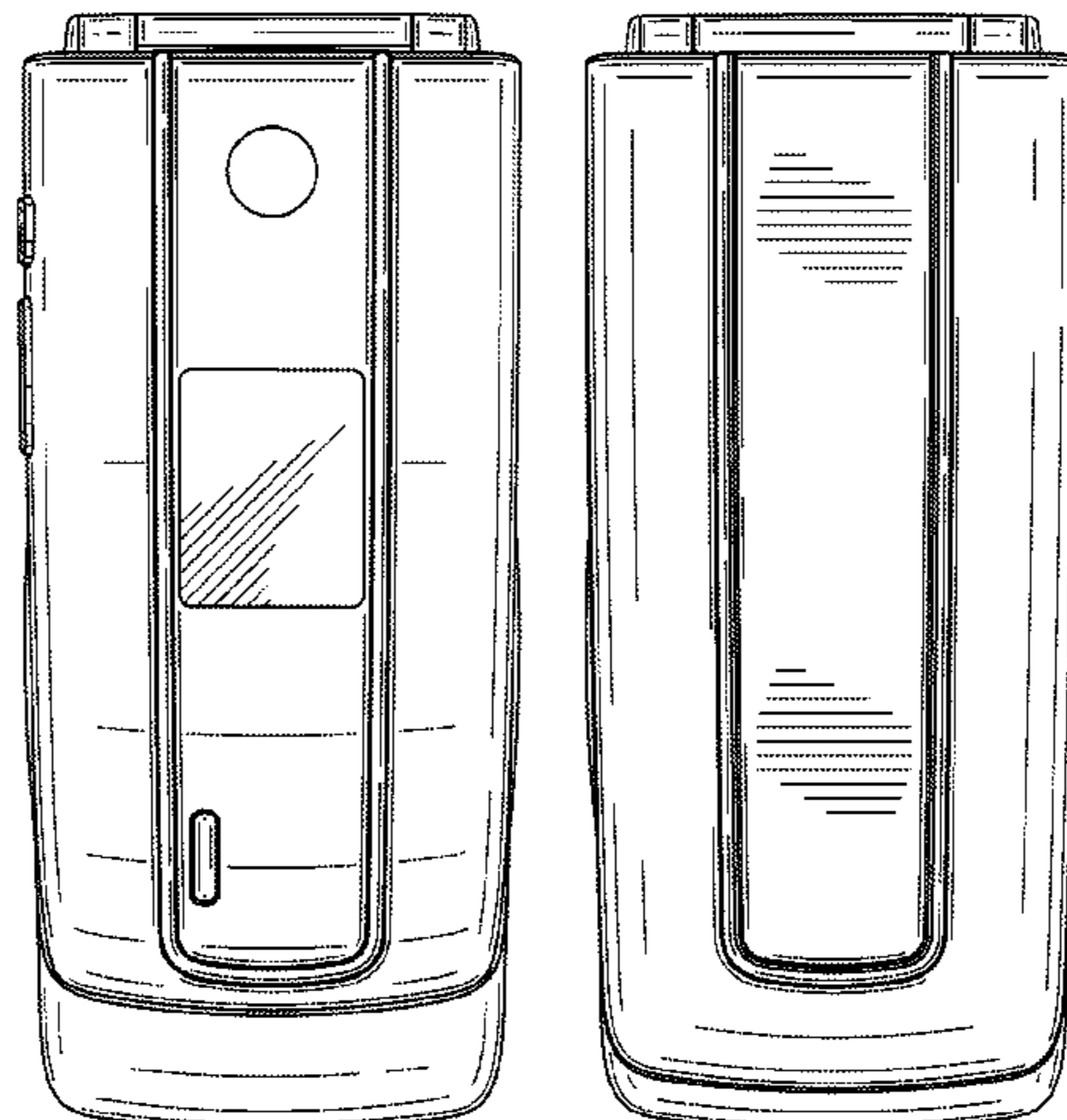

U.S. PATENT DOCUMENTS

D589,954 S * 4/2009 Lyles D14/248
D591,707 S * 5/2009 Wozniak D14/138 AB
D591,708 S * 5/2009 Wozniak D14/138 AB
D591,719 S * 5/2009 Millora et al. D14/138 AB
2004/0038703 A1* 2/2004 Noto et al. 455/550.1

OTHER PUBLICATIONS

Nokia 6555 telephone, announced Aug. 2007, [online], [site visited May 5, 2009]. Available from Internet ,<URL: <http://www.gsmarena.com>>.*

Nokia 6136 telephone, announced Feb. 2006, [online], [site visited May 5, 2009]. Available from Internet ,<URL: <http://www.gsmarena.com>>.*

Nokia 3555 telephone, announced Nov. 2007, [online], [site visited May 5, 2009]. Available from Internet ,<URL: <http://www.gsmarena.com>>.*

NEC N500iS telephone, announced Feb. 2006, [online], [site visited May 5, 2009]. Available from Internet ,<URL: <http://www.gsmarena.com>>.*

Samsung E490 telephone, announced Nov. 2006, [online], [site visited May 5, 2009]. Available from Internet ,<URL: <http://www.gsmarena.com>>.*

Alcatel OT-C701 telephone, announced Feb. 2007, [online], [site visited May 5, 2009]. Available from Internet ,<URL: <http://www.gsmarena.com>>.*

Motorola W375 telephone, announced Jun. 2006, [online], [site visited May 5, 2009]. Available from Internet ,<URL: <http://www.gsmarena.com>>.*

* cited by examiner

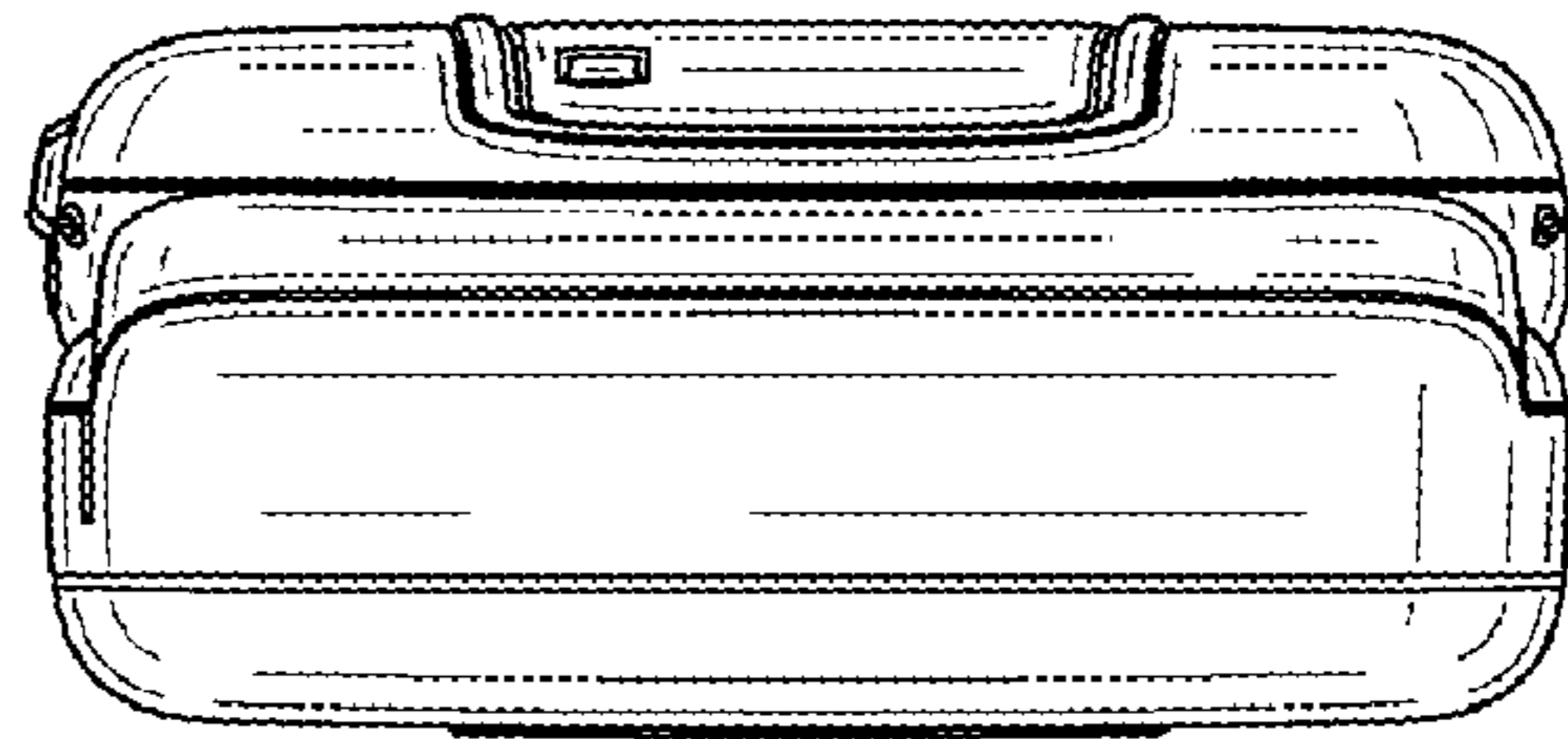

FIG. 1

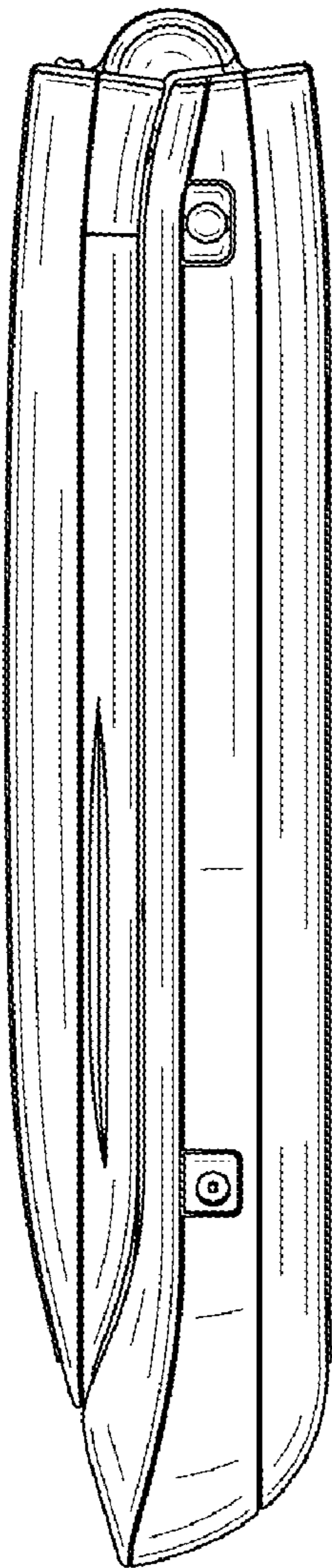

FIG. 2

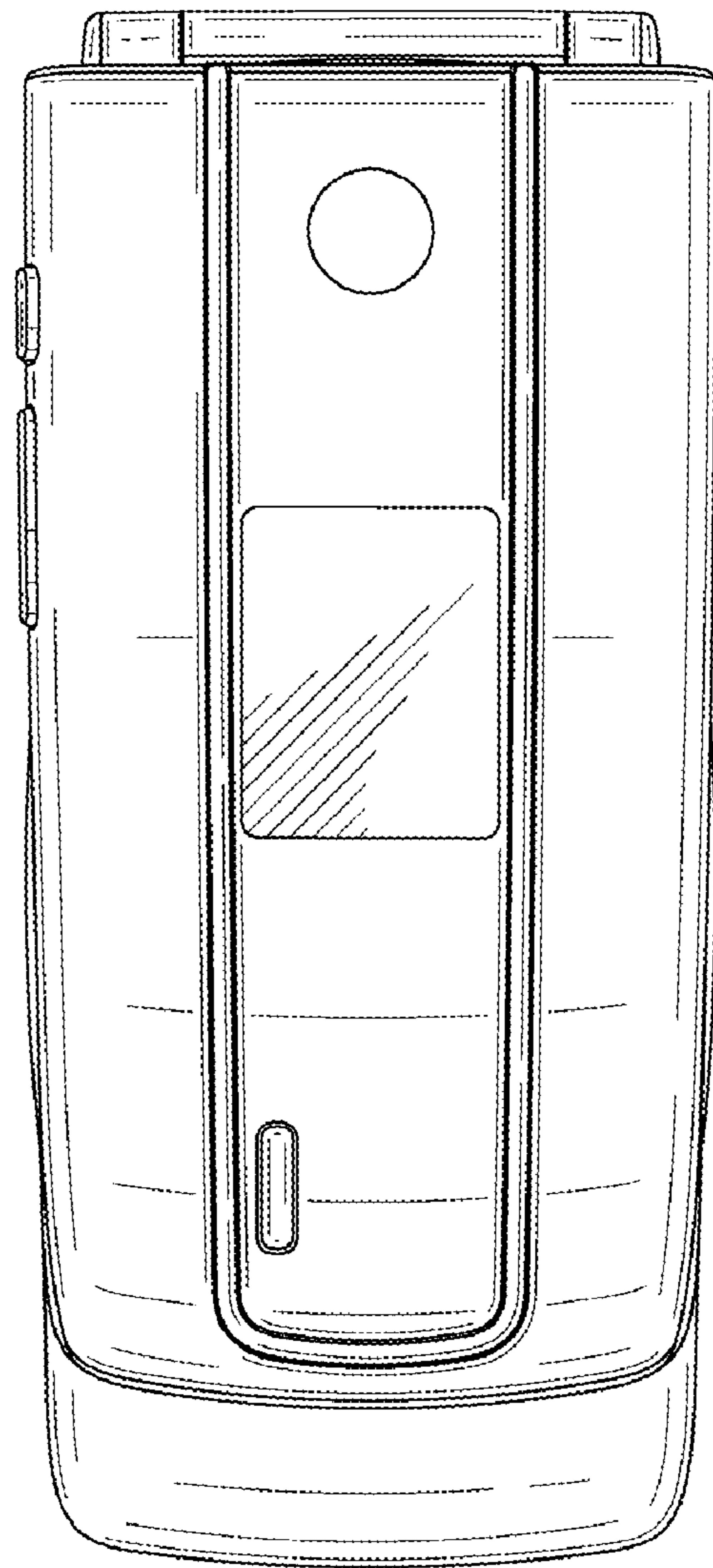

FIG. 3

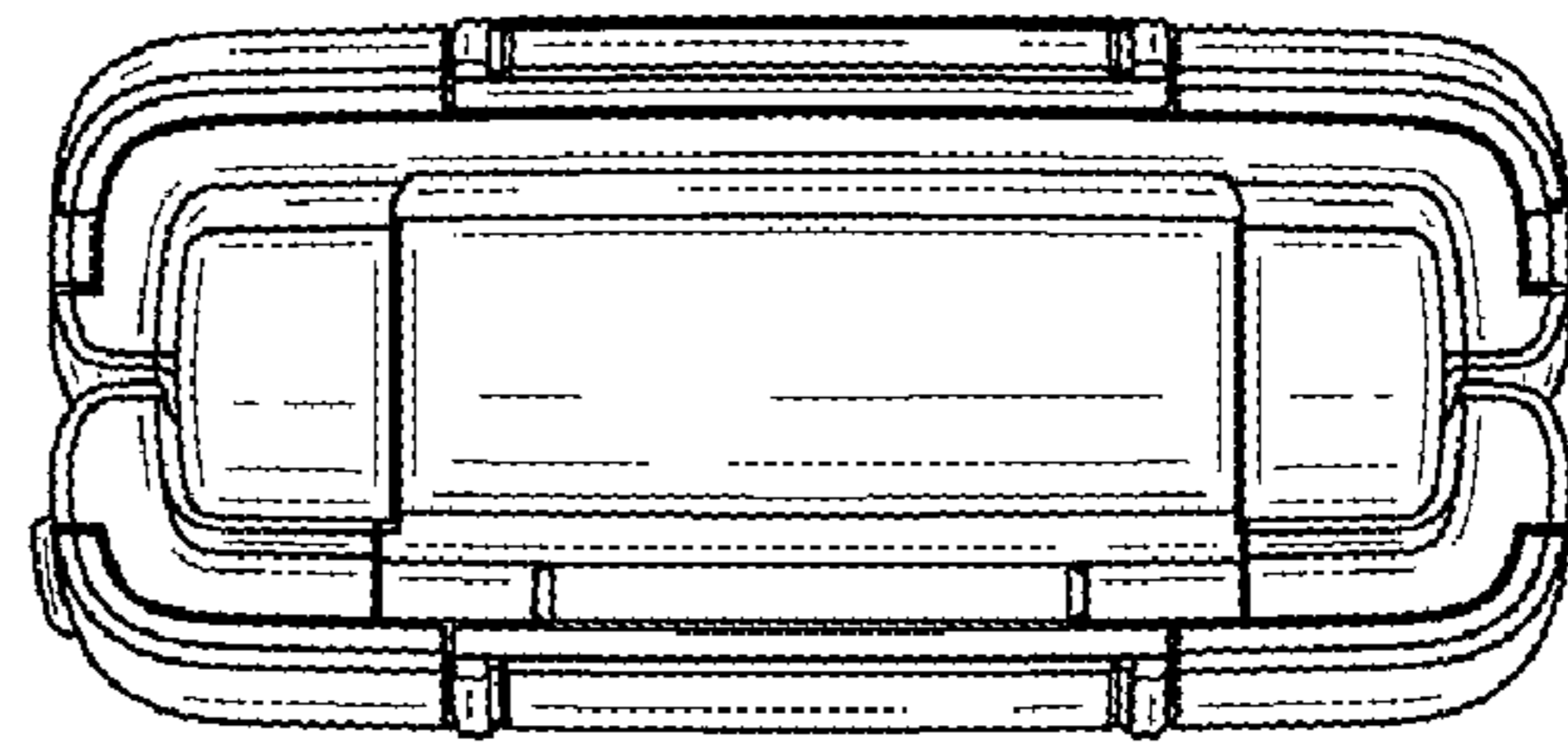

FIG. 5

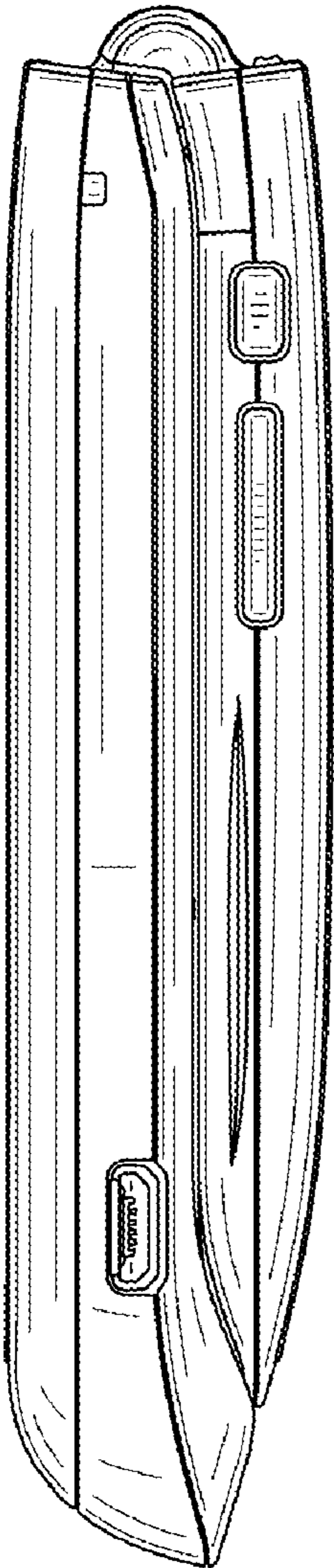

FIG. 4

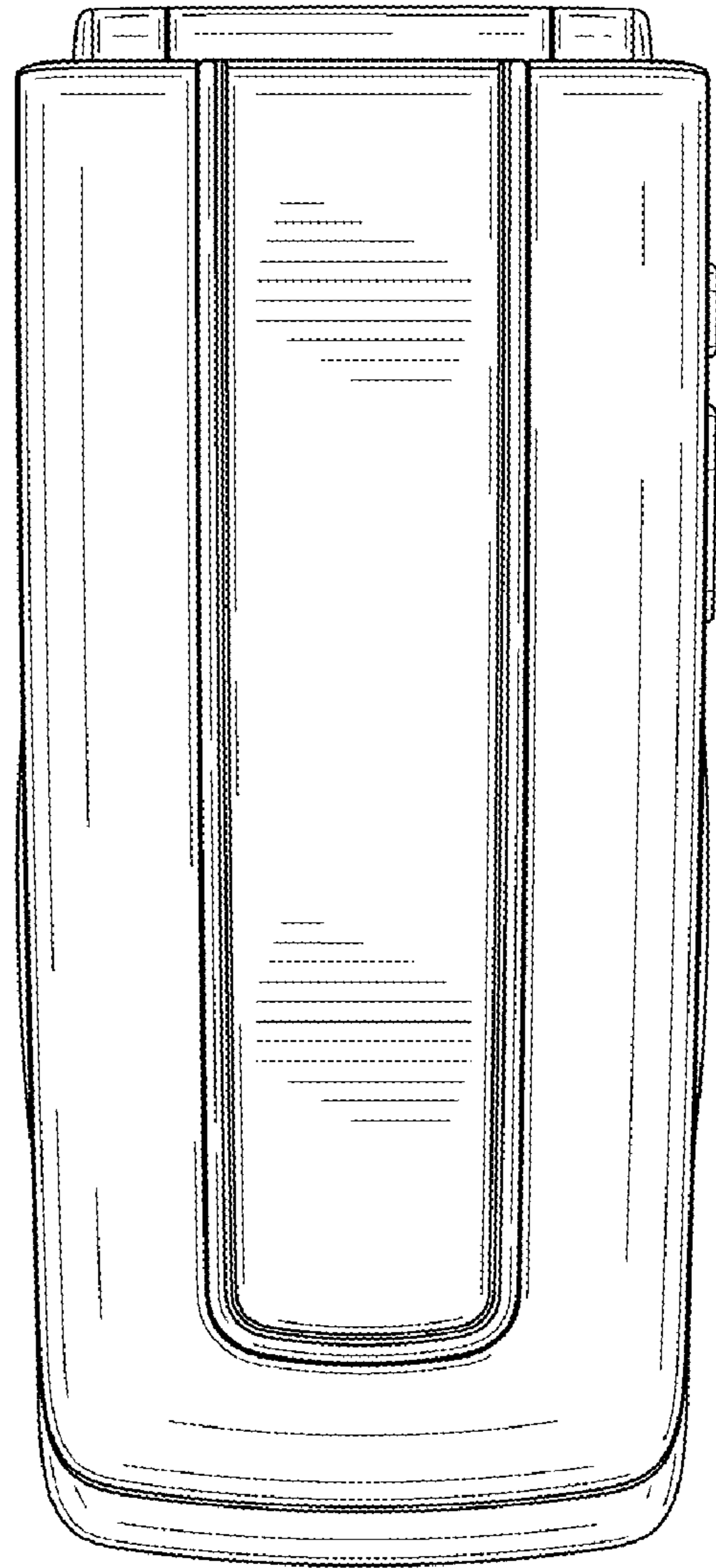

FIG. 6

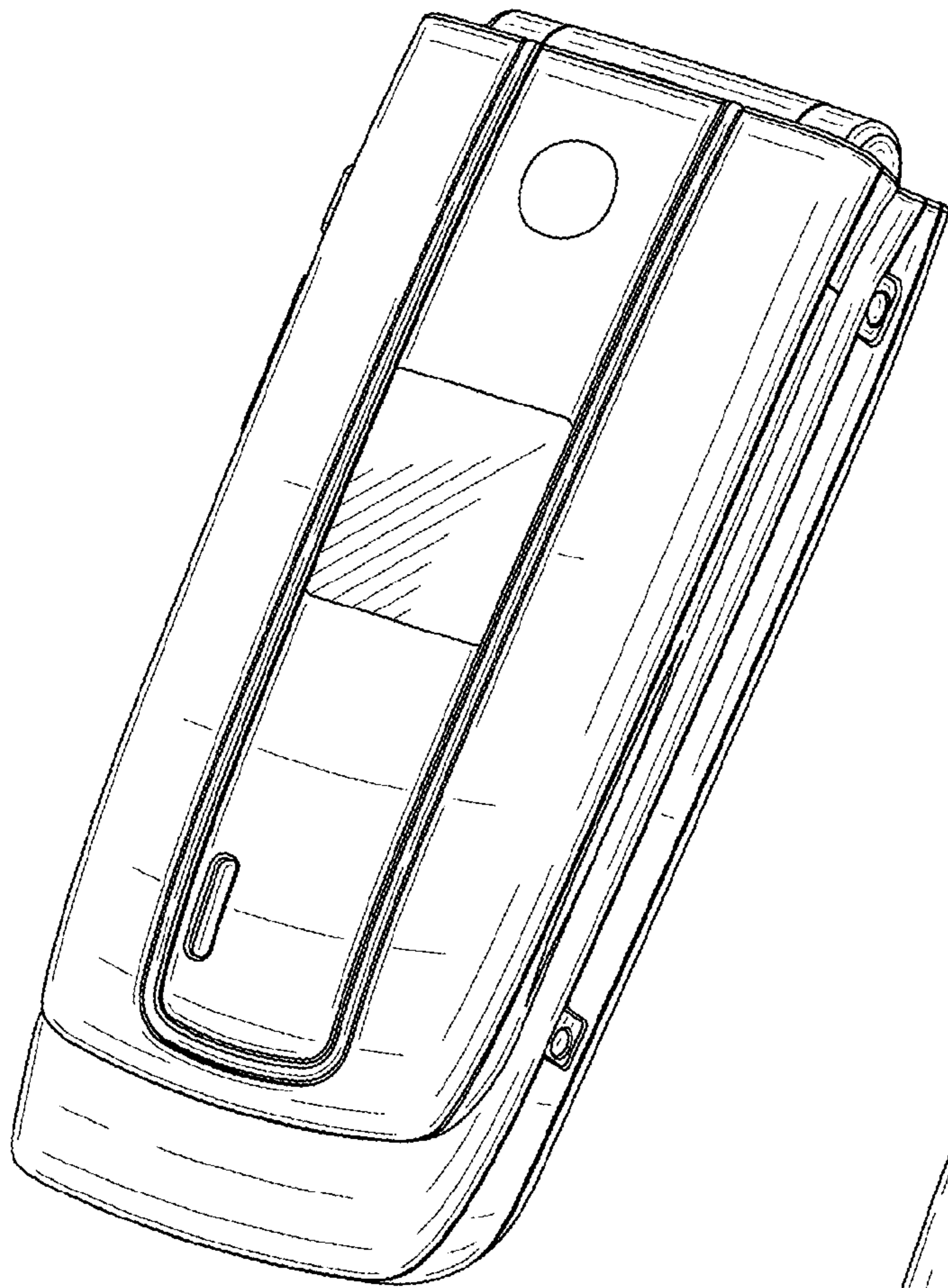

FIG. 7

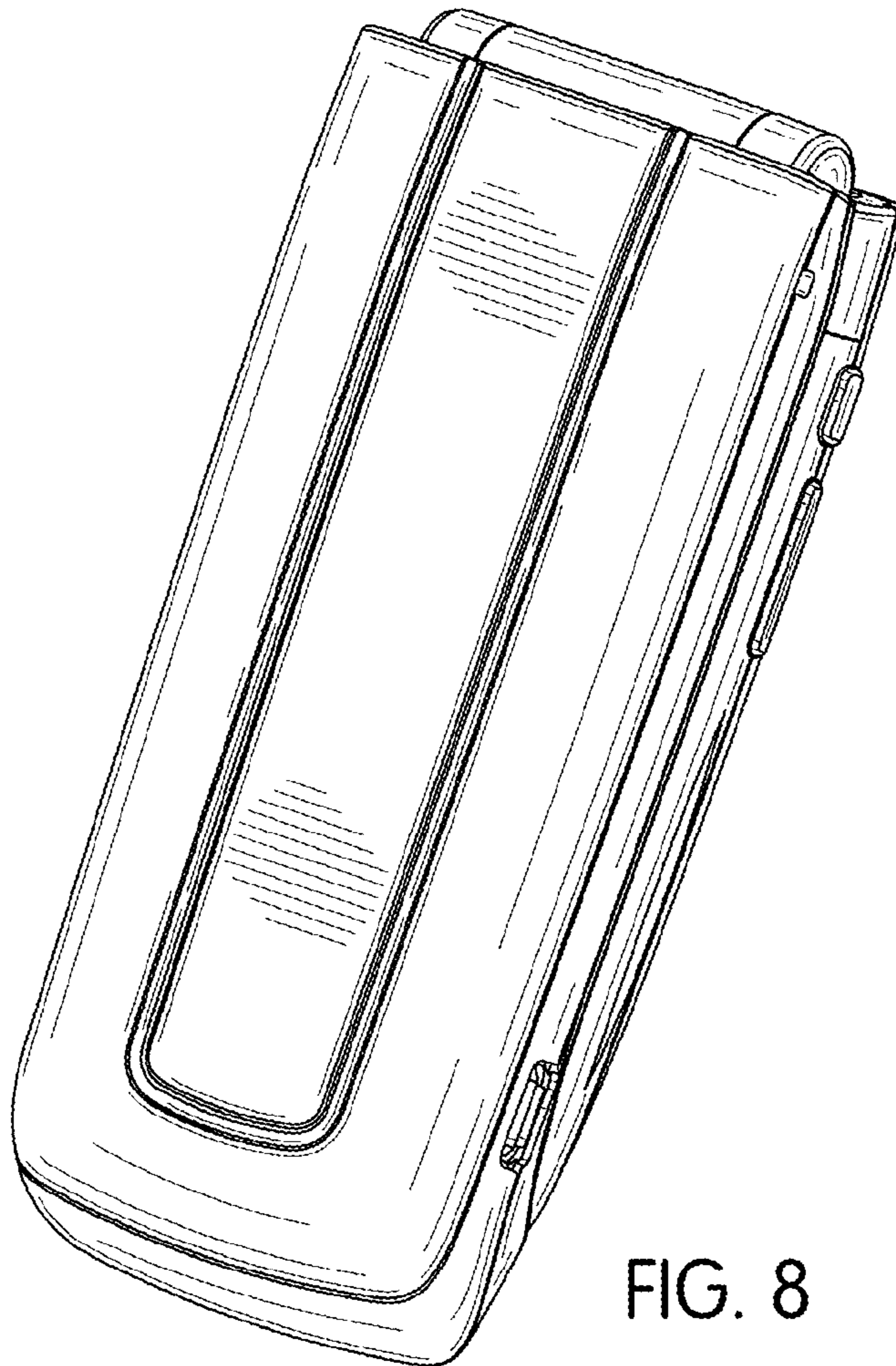

FIG. 8

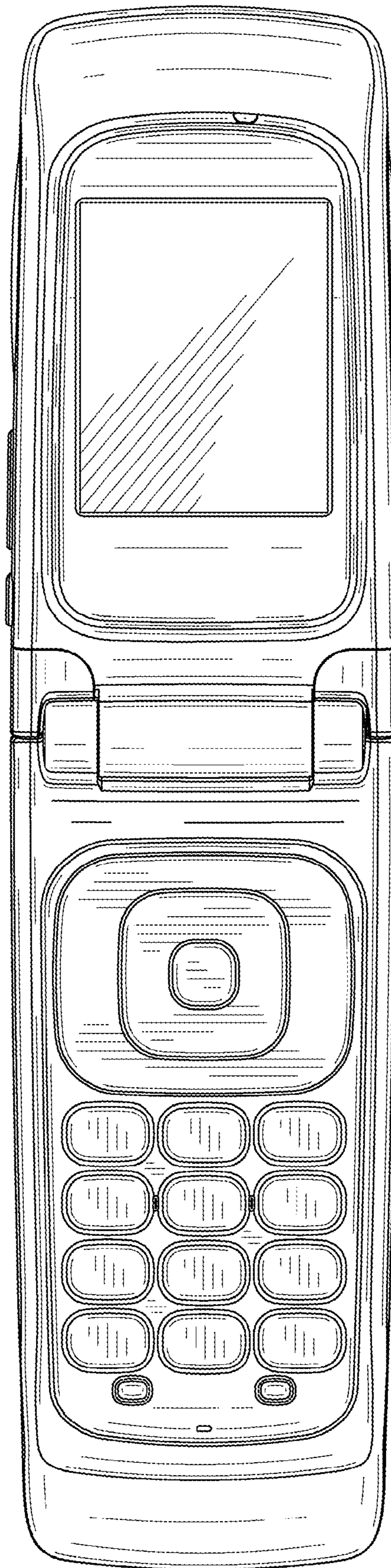
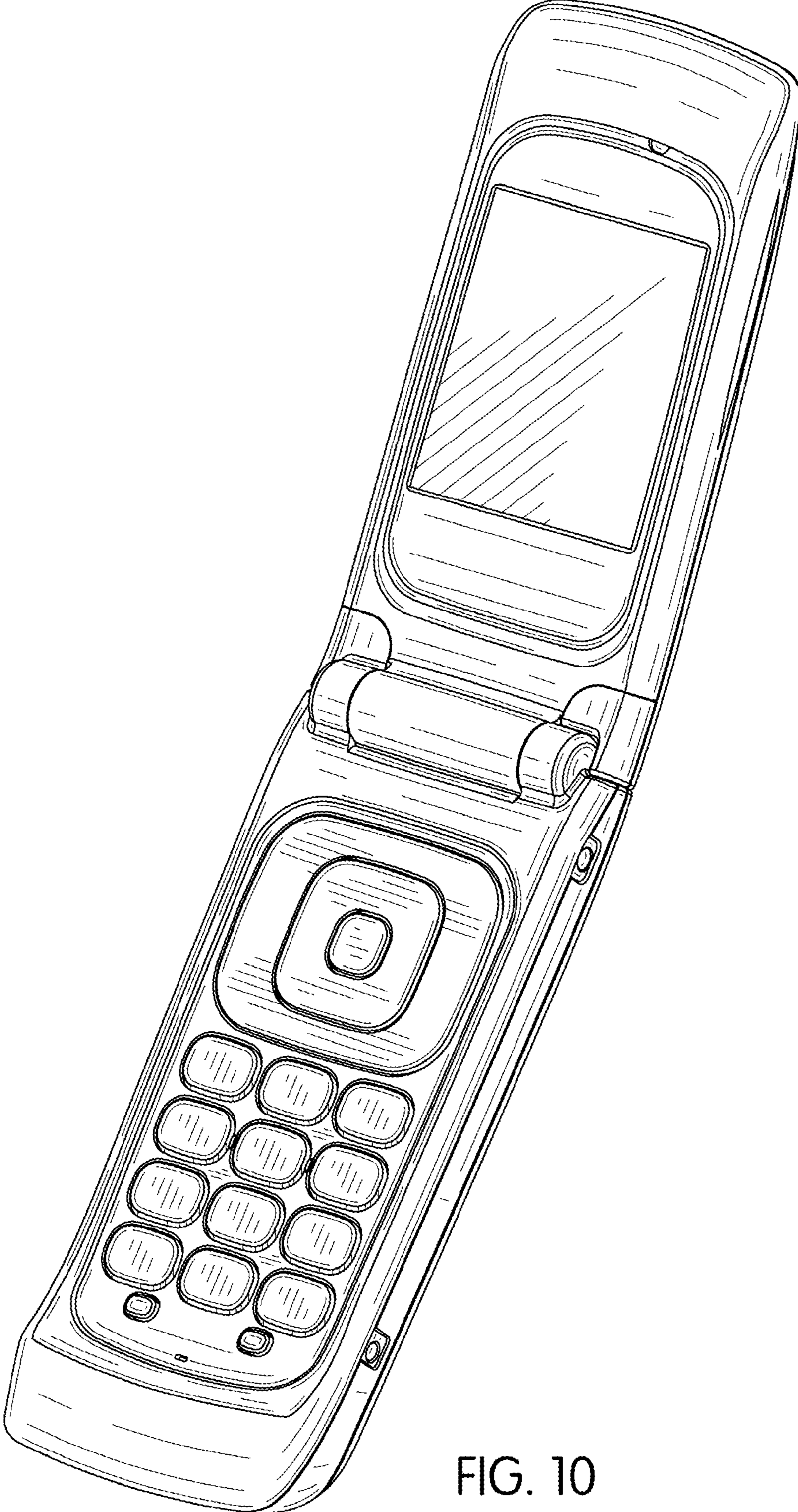

FIG. 9



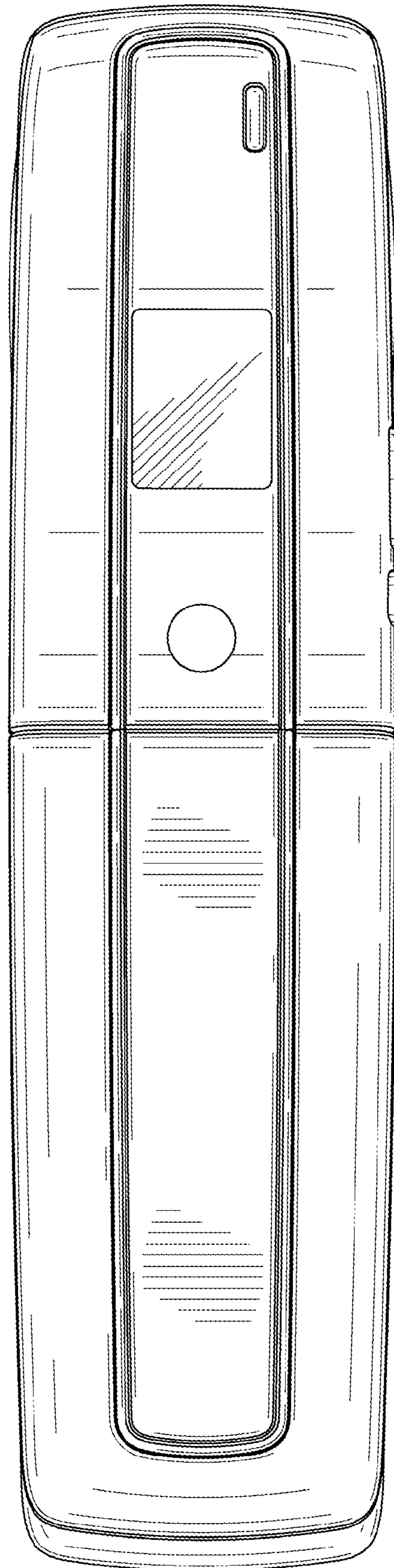

FIG. 11

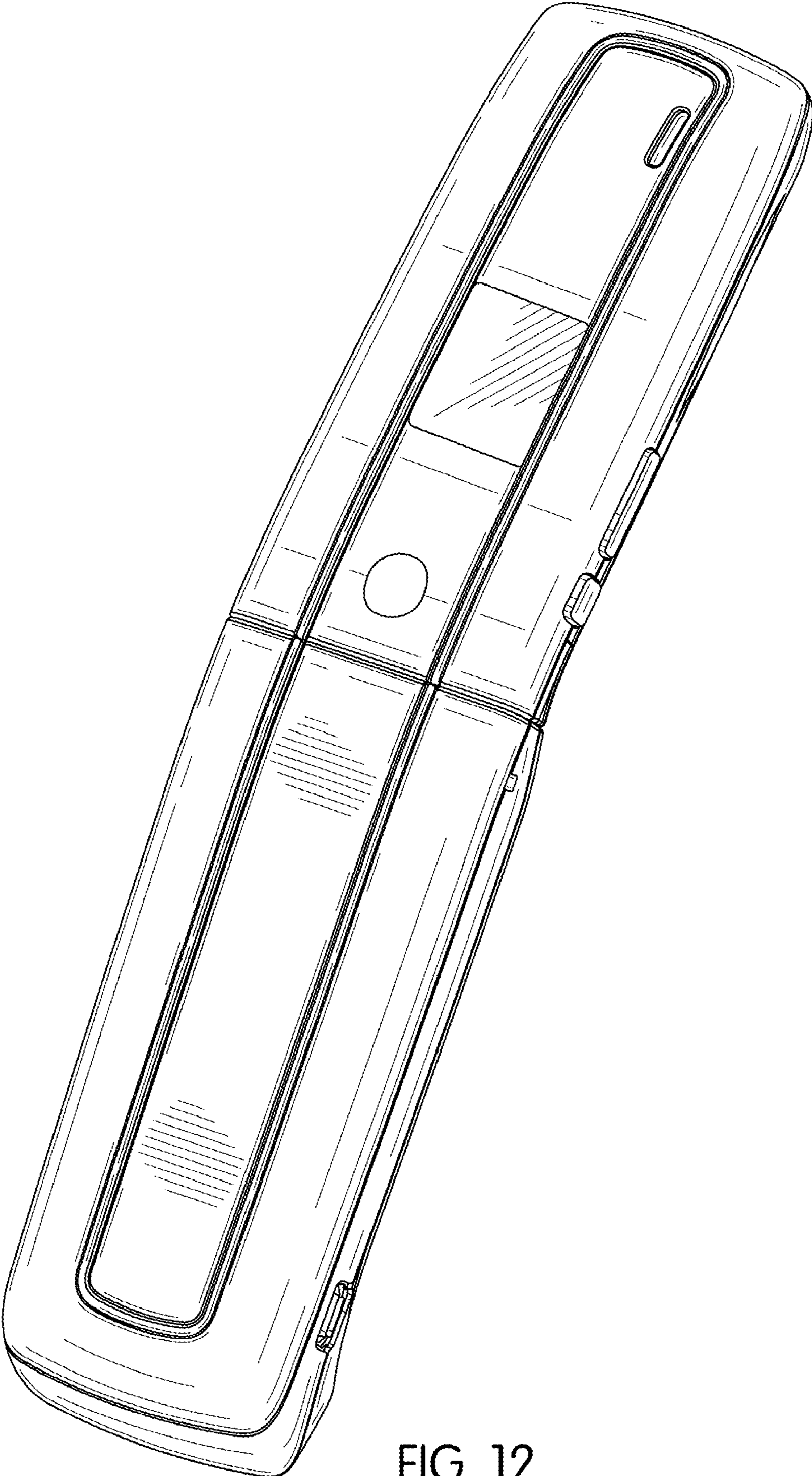

FIG. 12

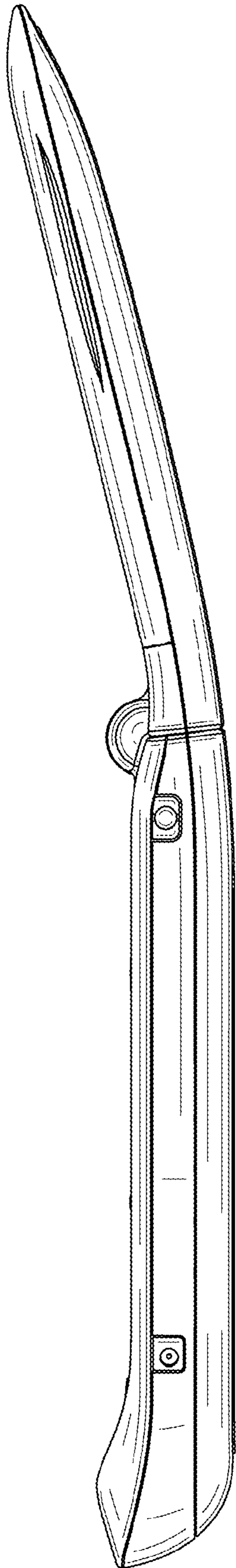

FIG. 13

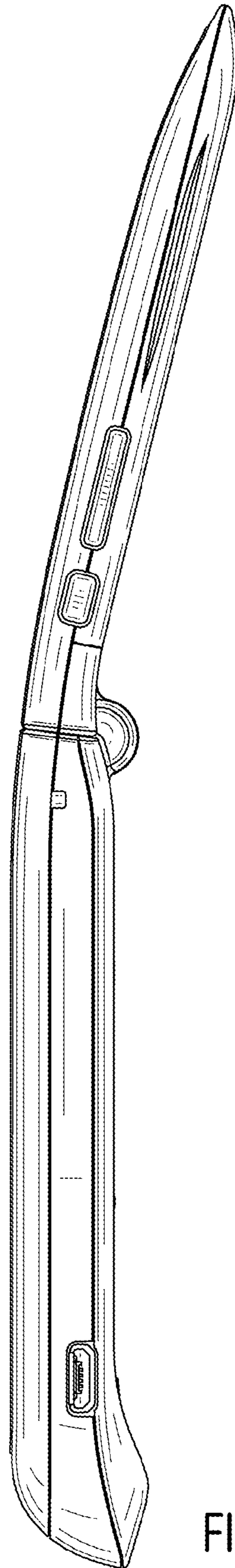

FIG. 14