



US00D600591S

(12) **United States Design Patent**
Kosh et al.

(10) **Patent No.:** **US D600,591 S**

(45) **Date of Patent:** **** Sep. 22, 2009**

(54) **BUCKLE LID**

(75) Inventors: **Matthew Kosh**, Seattle, WA (US); **John Tilden**, Seattle, WA (US)

(73) Assignee: **Bodypoint, Inc.**, Seattle, WA (US)

(**) Term: **14 Years**

(21) Appl. No.: **29/323,186**

(22) Filed: **Aug. 20, 2008**

(51) **LOC (9) Cl.** **02-07**

(52) **U.S. Cl.** **D11/216**

(58) **Field of Classification Search** D11/1-2,
D11/200-201, 206-210, 214-218; 24/163 R,
24/169-171, 173, 177-179, 191, 194-195,
24/197, 200

See application file for complete search history.

(56) **References Cited**

U.S. PATENT DOCUMENTS

D101,946 S *	11/1936	Freysinger	D11/216
3,078,538 A *	2/1963	Brown	24/646
D359,709 S *	6/1995	Miller	D11/216
D417,170 S *	11/1999	Proctor	D11/216
D478,023 S *	8/2003	Chen	D11/216
D567,709 S *	4/2008	Cho	D11/216
D575,671 S *	8/2008	Niwa	D11/216

* cited by examiner

Primary Examiner—R. Seifert

(74) *Attorney, Agent, or Firm*—Townsend and Townsend and Crew LLP

(57) **CLAIM**

The ornamental design for buckle lid, as shown and described.

DESCRIPTION

FIG. 1 is a perspective view of a first embodiment of a buckle lid showing our new design;

FIG. 2 is a front elevational view;

FIG. 3 is a rear elevational view thereof;

FIG. 4 is a right side elevational view thereof;

FIG. 5 is a left side elevational view thereof;

FIG. 6 is a top plan view thereof;

FIG. 7 is a bottom plan view thereof.

FIG. 8 is a perspective view of a second embodiment of a buckle lid showing our new design;

FIG. 9 is a front elevational view of FIG. 8;

FIG. 10 is a rear elevational view of FIG. 8;

FIG. 11 is a right side elevational view of FIG. 8;

FIG. 12 is a left side elevational view of FIG. 8;

FIG. 13 is a top plan view of FIG. 8; and,

FIG. 14 is a bottom plan view of FIG. 8.

The broken line showing is for illustrative purposes only and forms no part of the claimed design.

1 Claim, 4 Drawing Sheets

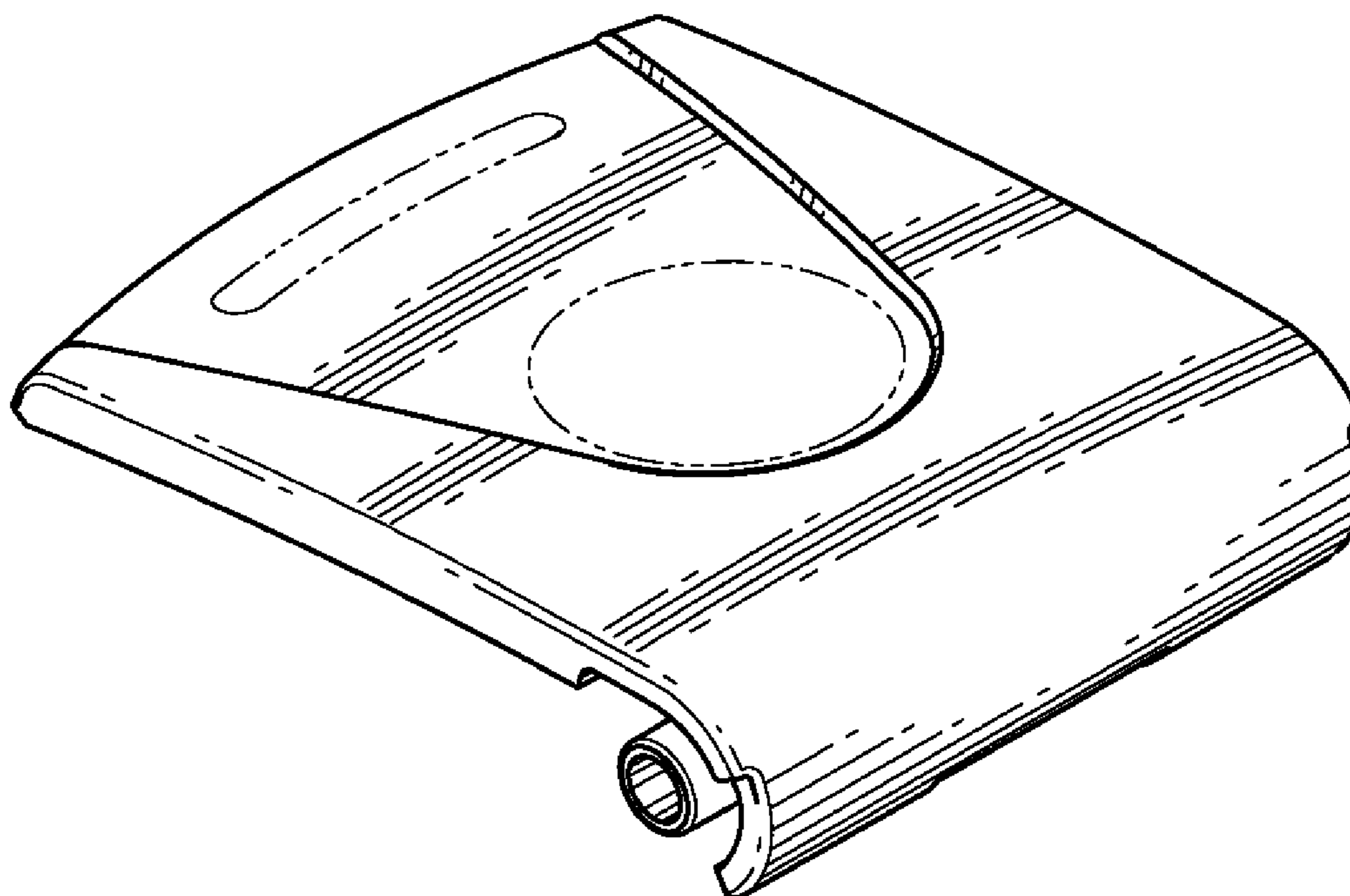

FIG. 1

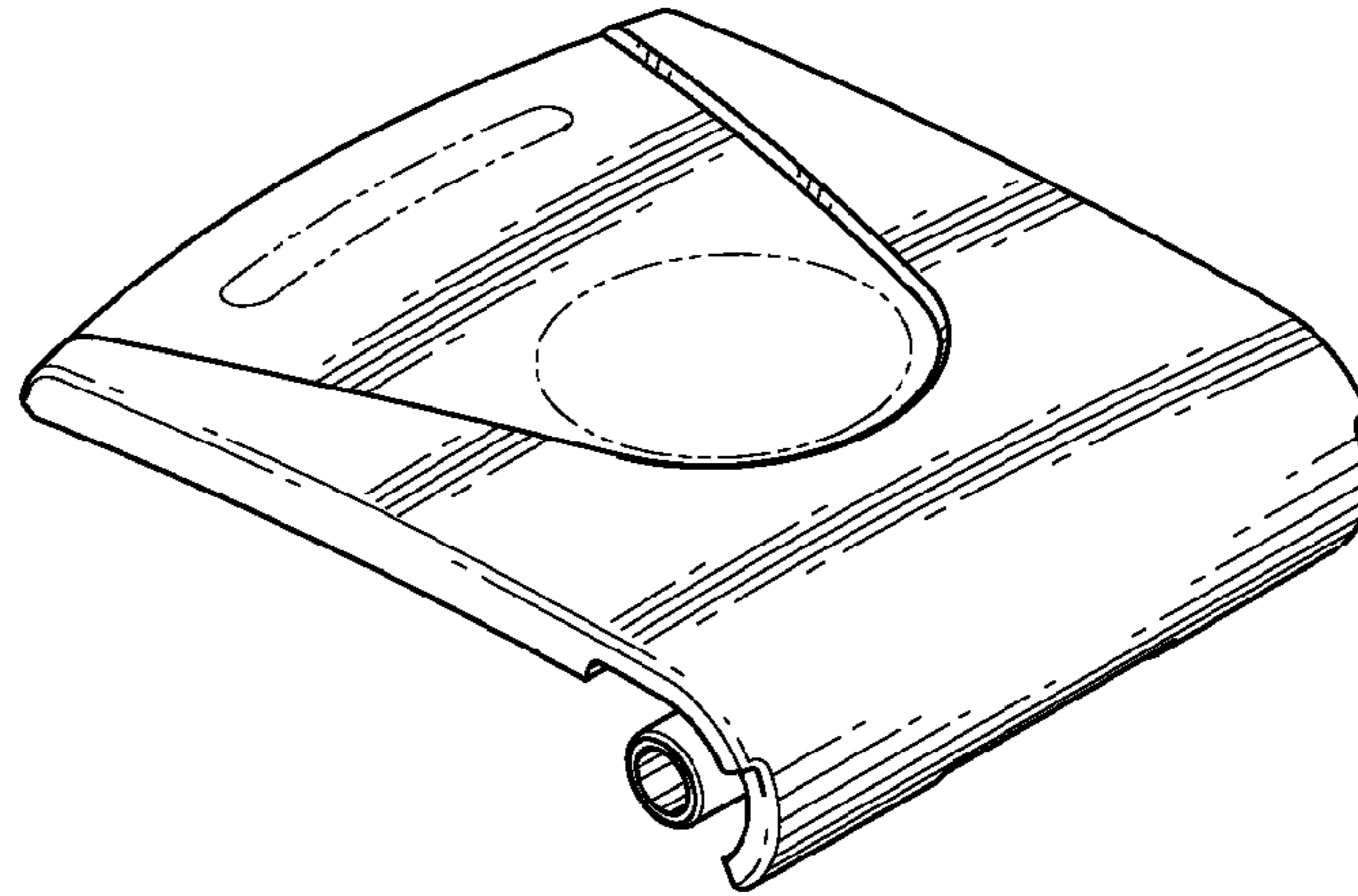

FIG. 2

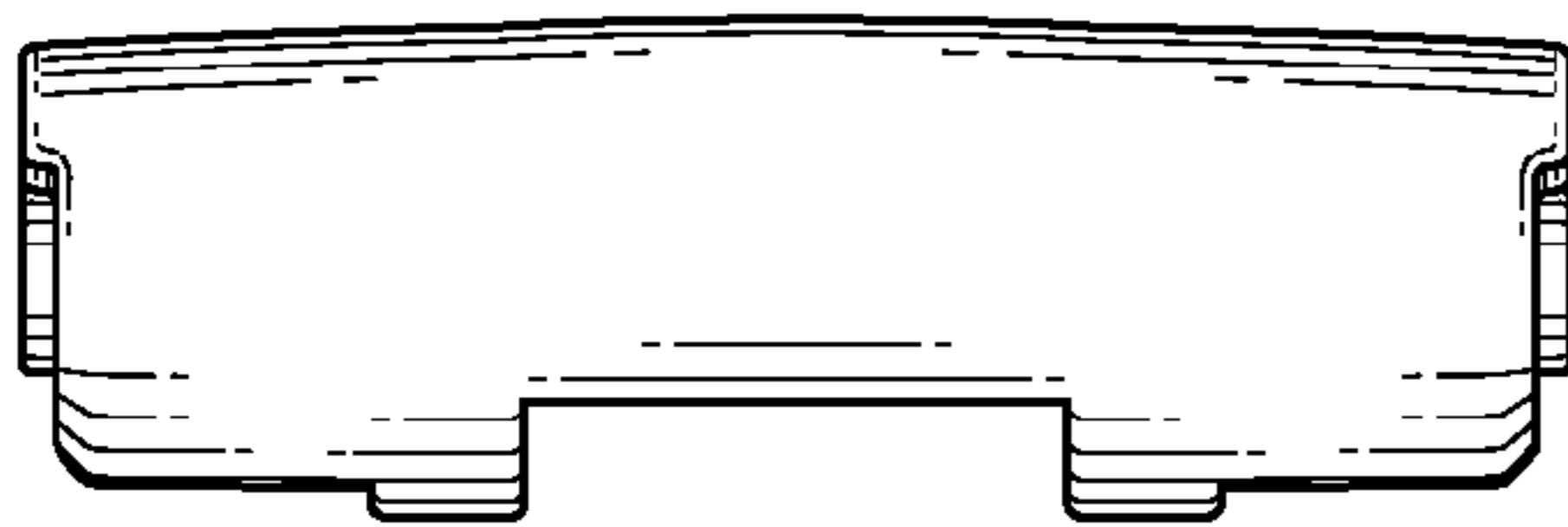

FIG. 3

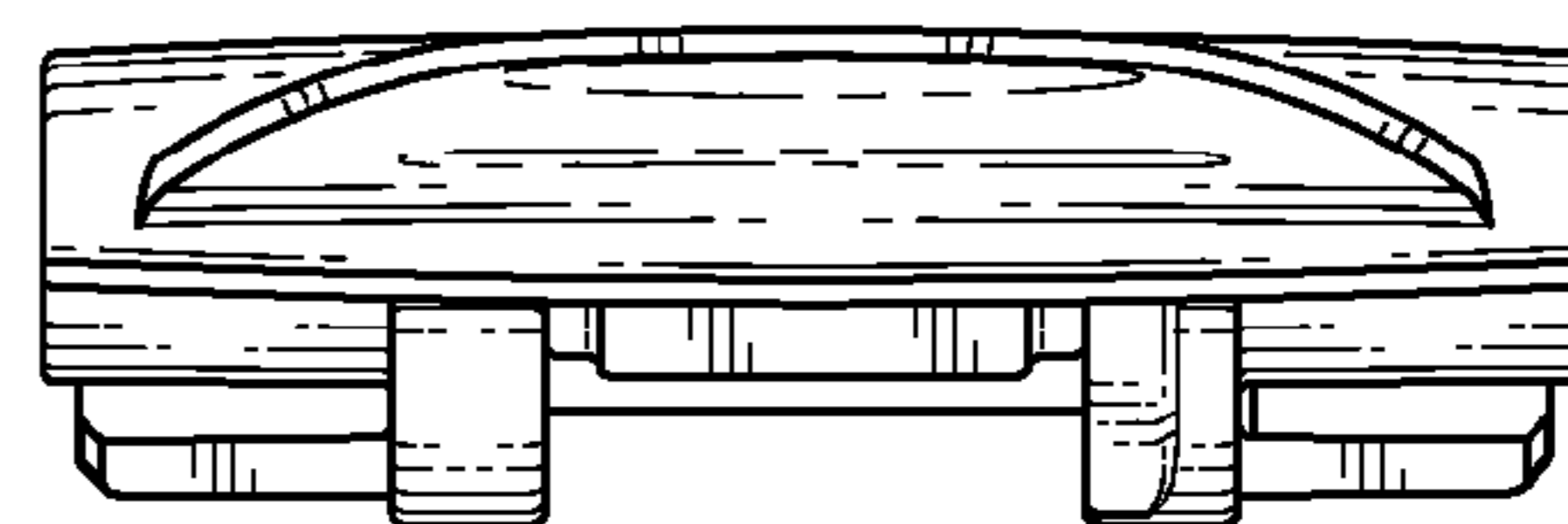

FIG. 4

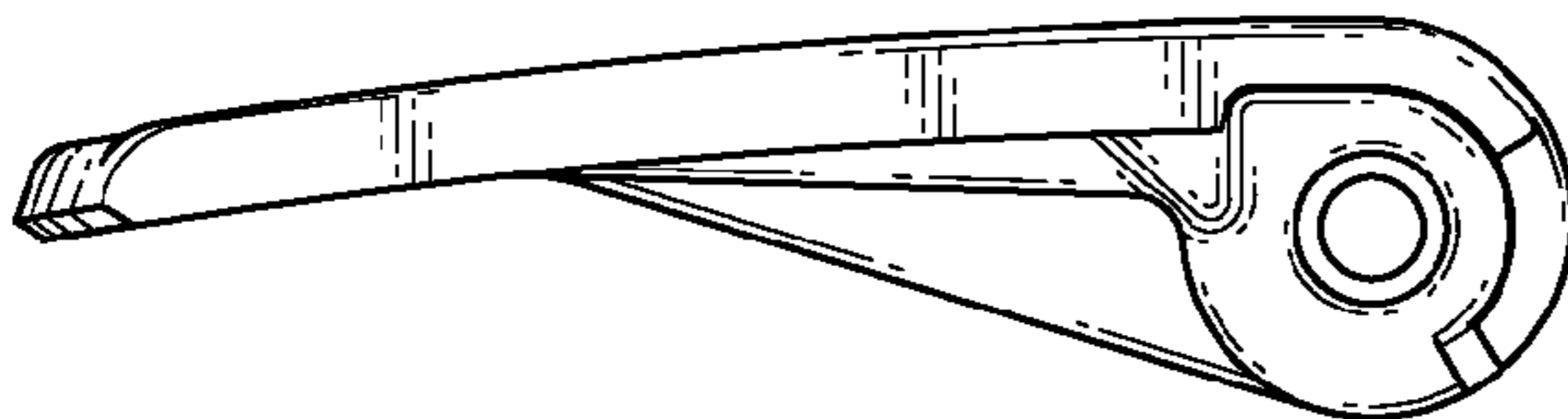

FIG. 5

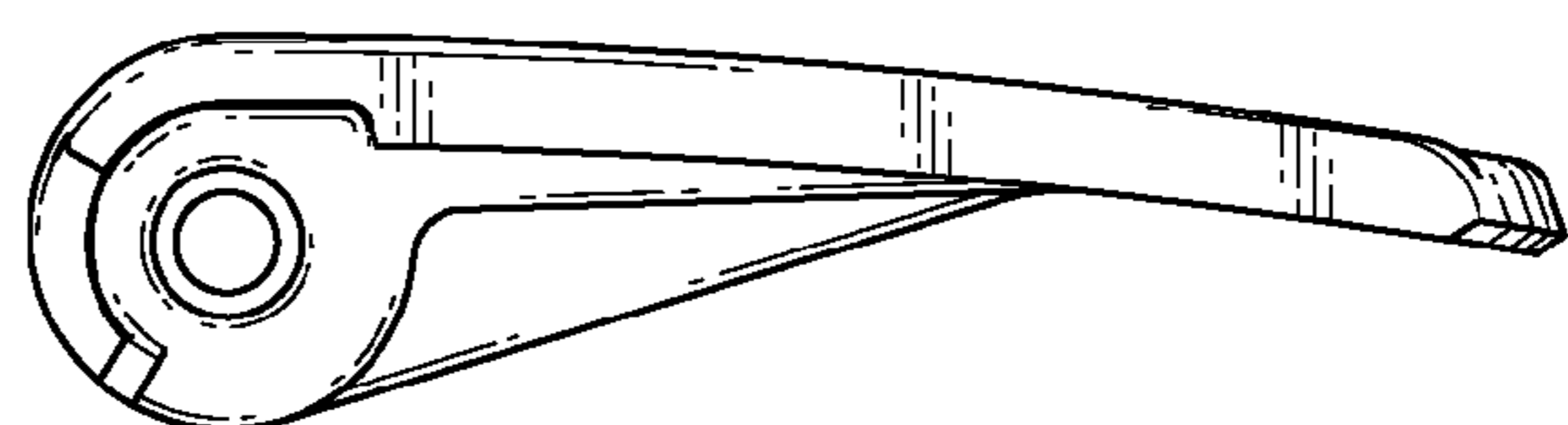

FIG. 6

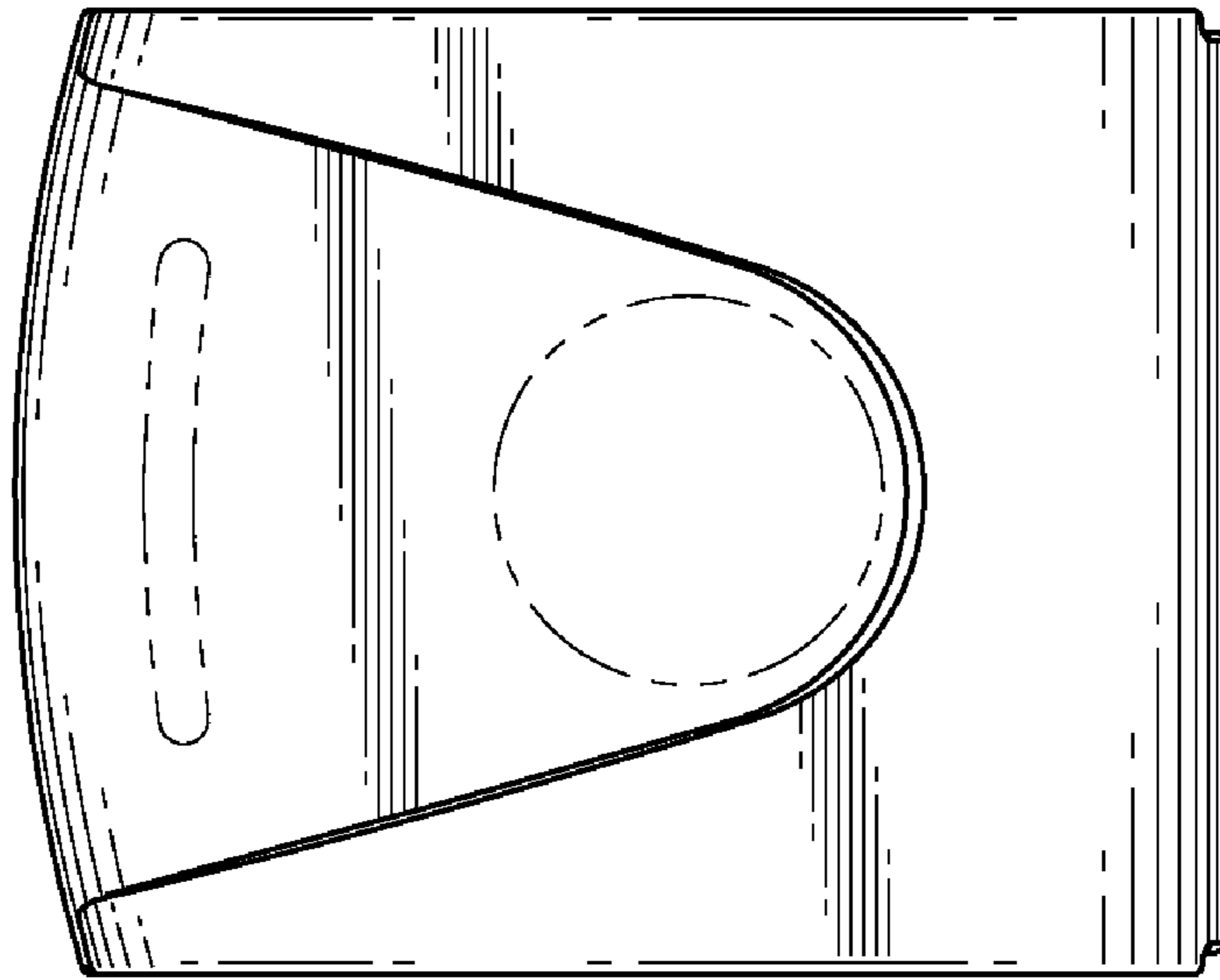

FIG. 7

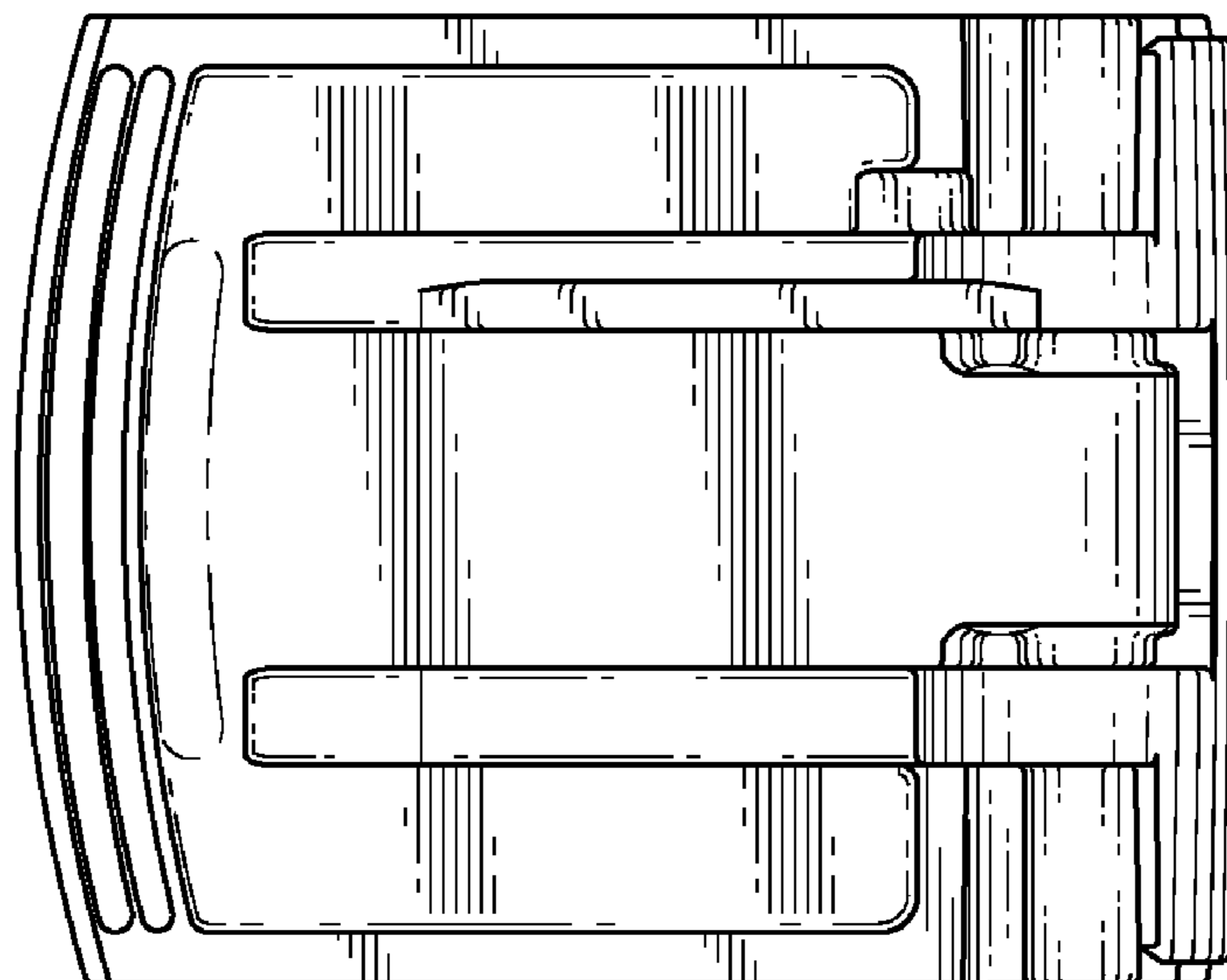

FIG. 8

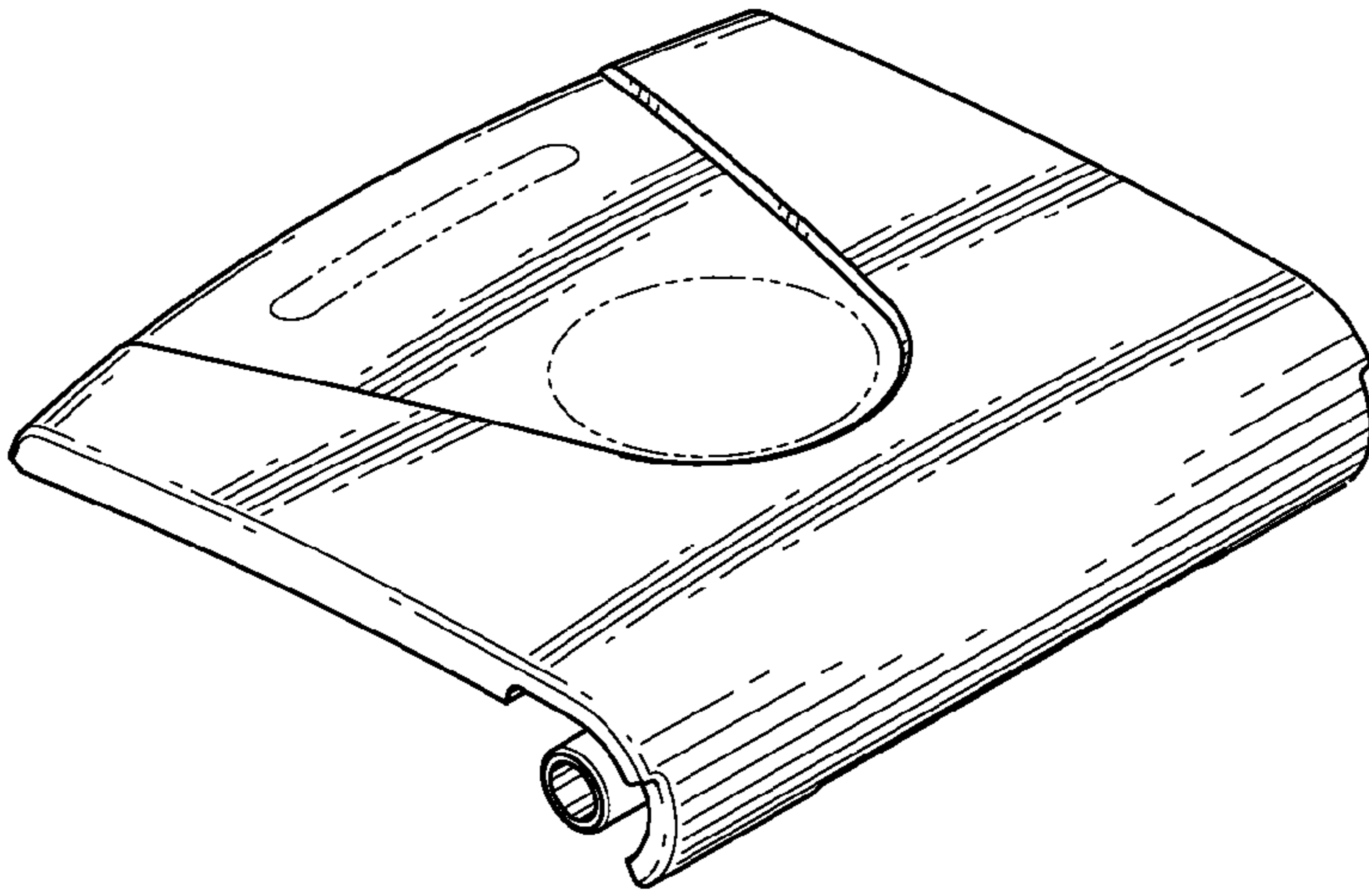

FIG. 9

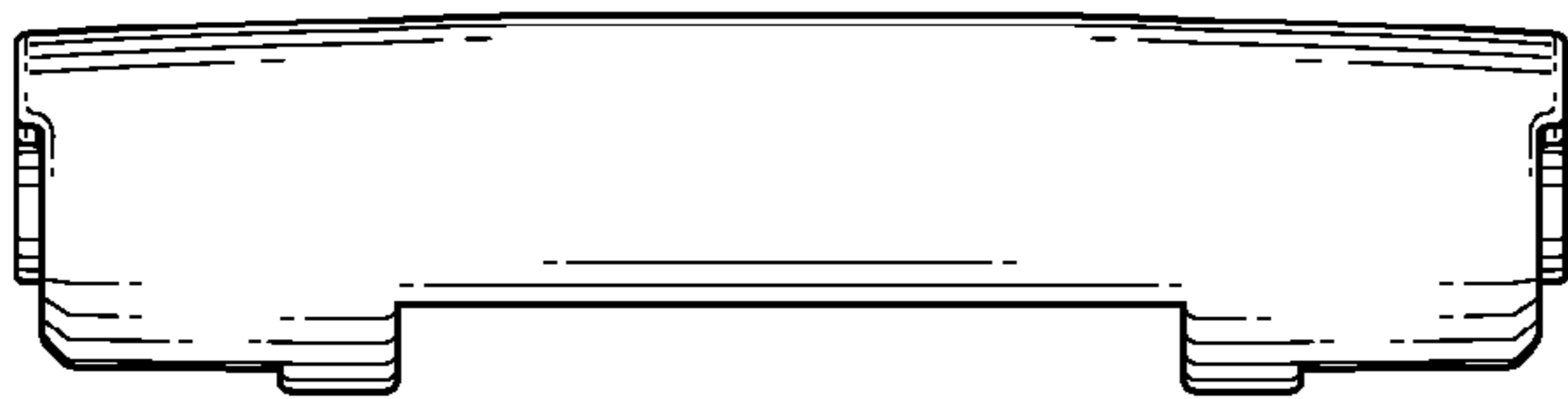

FIG. 10

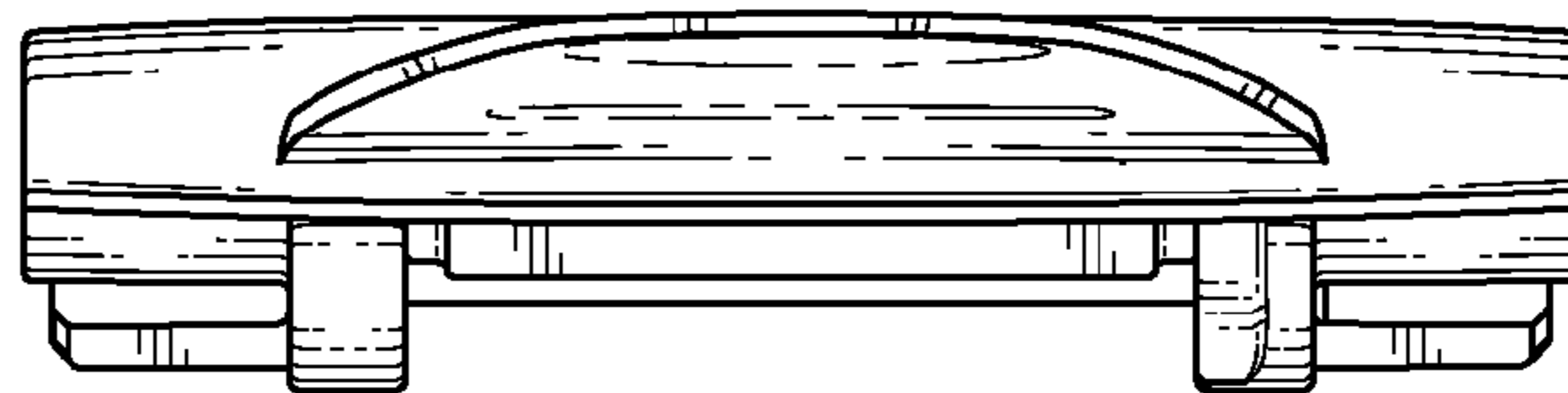

FIG. 11

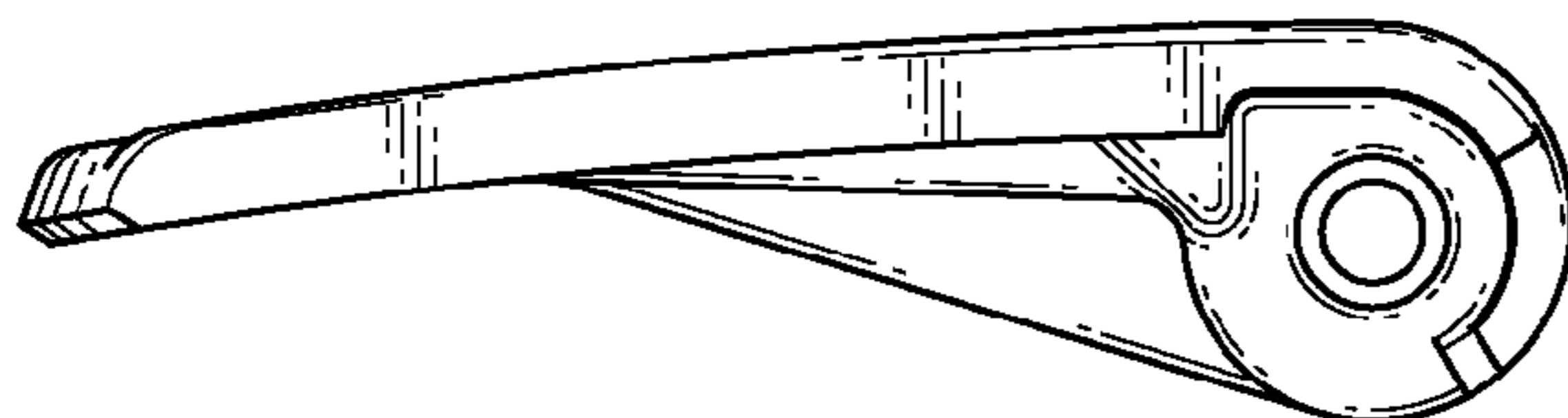

FIG. 12

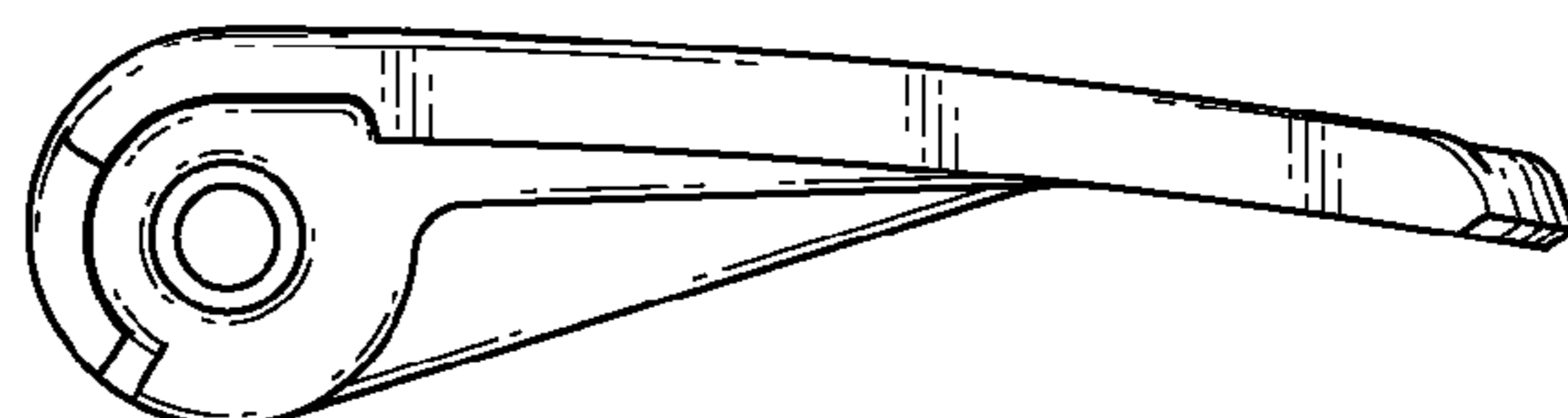

FIG. 13

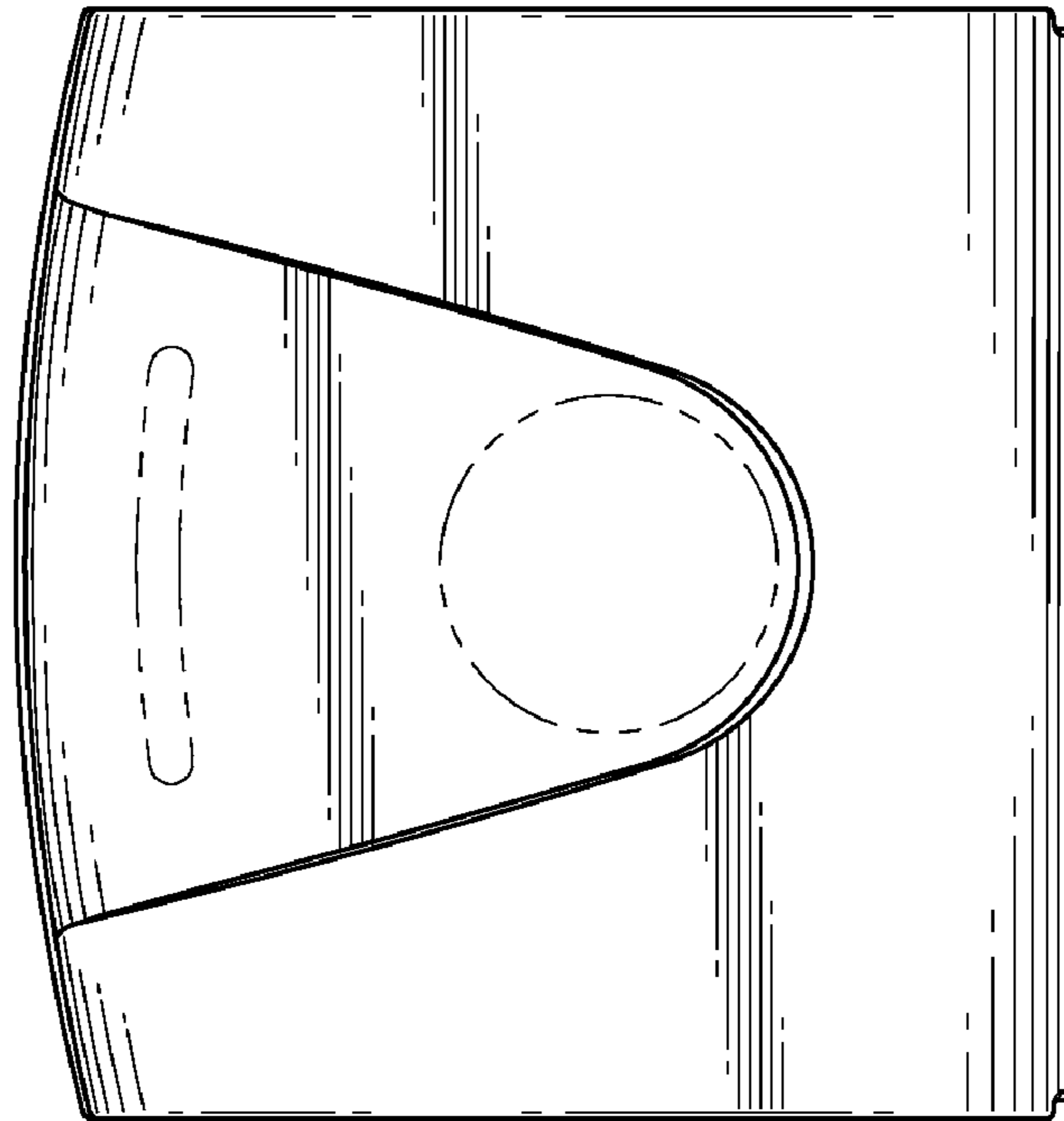

FIG. 14

