



US00D600578S

(12) **United States Design Patent**
Tsuji

(10) **Patent No.:** **US D600,578 S**

(45) **Date of Patent:** **** Sep. 22, 2009**

(54) **BACTERIA MEASURING INSTRUMENT**

(75) Inventor: **Kaichi Tsuji**, Kusatsu (JP)

(73) Assignee: **Daikin Industries Ltd.**, Osaka (JP)

(**) Term: **14 Years**

(21) Appl. No.: **29/309,272**

(22) Filed: **Jul. 17, 2008**

(30) **Foreign Application Priority Data**

Apr. 2, 2008	(JP)	2008-008448
Apr. 2, 2008	(JP)	2008-008449

(51) **LOC (9) Cl.** **10-04**

(52) **U.S. Cl.** **D10/81; D24/232**

(58) **Field of Classification Search** D10/81;
D24/216, 232-234; 356/246, 440, 442; 422/67;
435/29, 34, 283.1, 286.1, 288.7, 303.1, 809
See application file for complete search history.

(56) **References Cited**

U.S. PATENT DOCUMENTS

4,221,867	A *	9/1980	McFadden	435/32
4,971,900	A *	11/1990	Ahnell et al.	435/29
D347,478	S *	5/1994	Pinkney	D24/216
D351,469	S *	10/1994	Okamoto et al.	D24/169
D591,864	S *	5/2009	Schmidt	D24/216
2004/0219627	A1 *	11/2004	Kawashima	435/29
2009/0020721	A1 *	1/2009	Ohmi et al.	251/331
2009/0042267	A1 *	2/2009	Park	435/283.1

* cited by examiner

Primary Examiner—Antoine D Davis
(74) *Attorney, Agent, or Firm*—Manabu Kanesaka

(57) **CLAIM**

The ornamental design for a bacteria measuring instrument, as shown and described.

DESCRIPTION

FIG. 1 is a perspective view of a bacteria measuring instrument showing my new design;

FIG. 2 is a front view thereof;

FIG. 3 is a rear view thereof;

FIG. 4 is a plan view thereof;

FIG. 5 is a bottom plan view thereof;

FIG. 6 is a left side view thereof;

FIG. 7 is a right side view thereof;

FIG. 8 is a perspective view of a modified example of the bacteria measuring instrument;

FIG. 9 is a front view of the modified example thereof;

FIG. 10 is a rear view of the modified example thereof;

FIG. 11 is a plan view of the modified example thereof;

FIG. 12 is a bottom plan view of the modified example thereof;

FIG. 13 is a left side view of the modified example thereof; and,

FIG. 14 is a right side view of the modified example thereof.

1 Claim, 12 Drawing Sheets

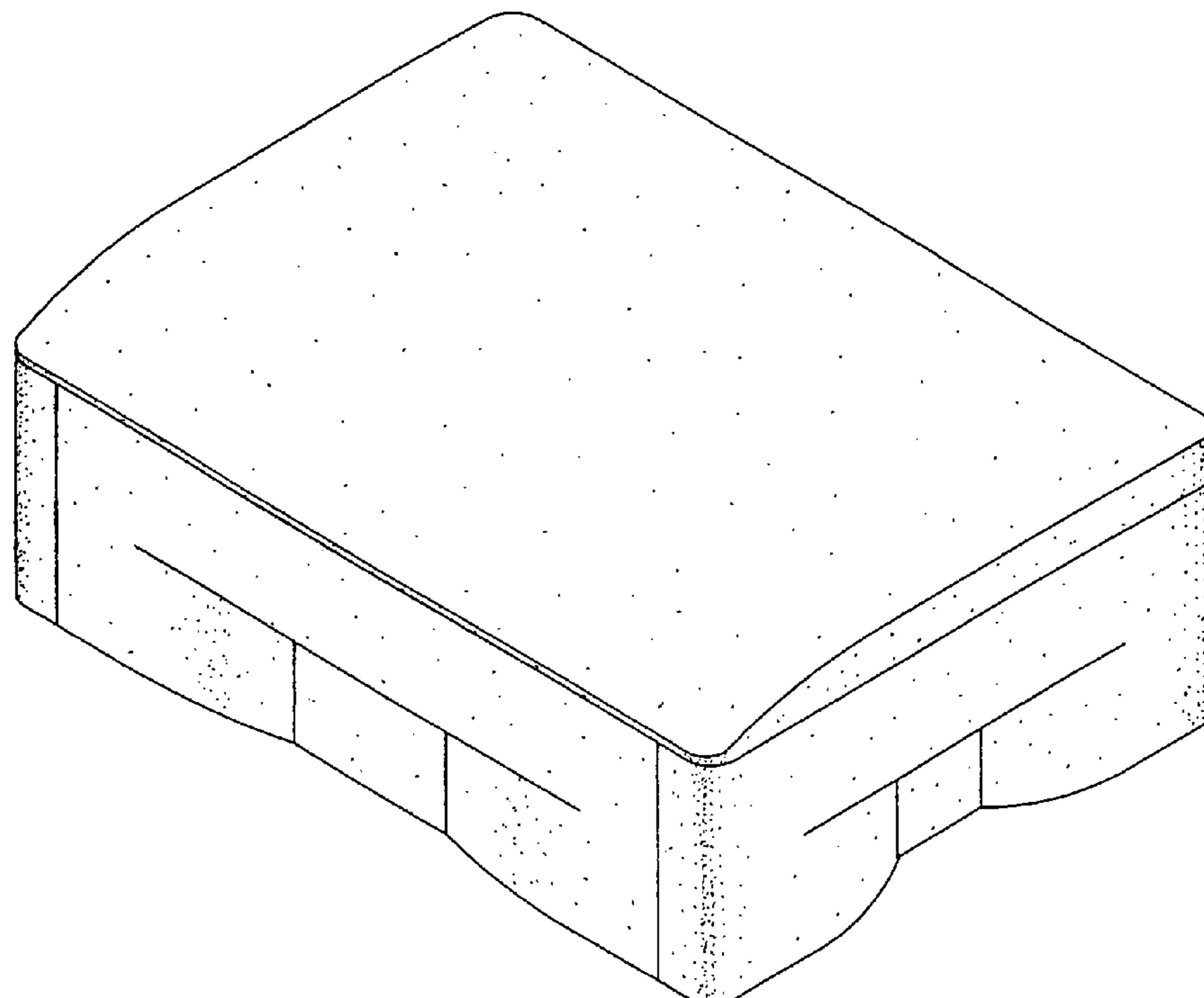

Fig. 1

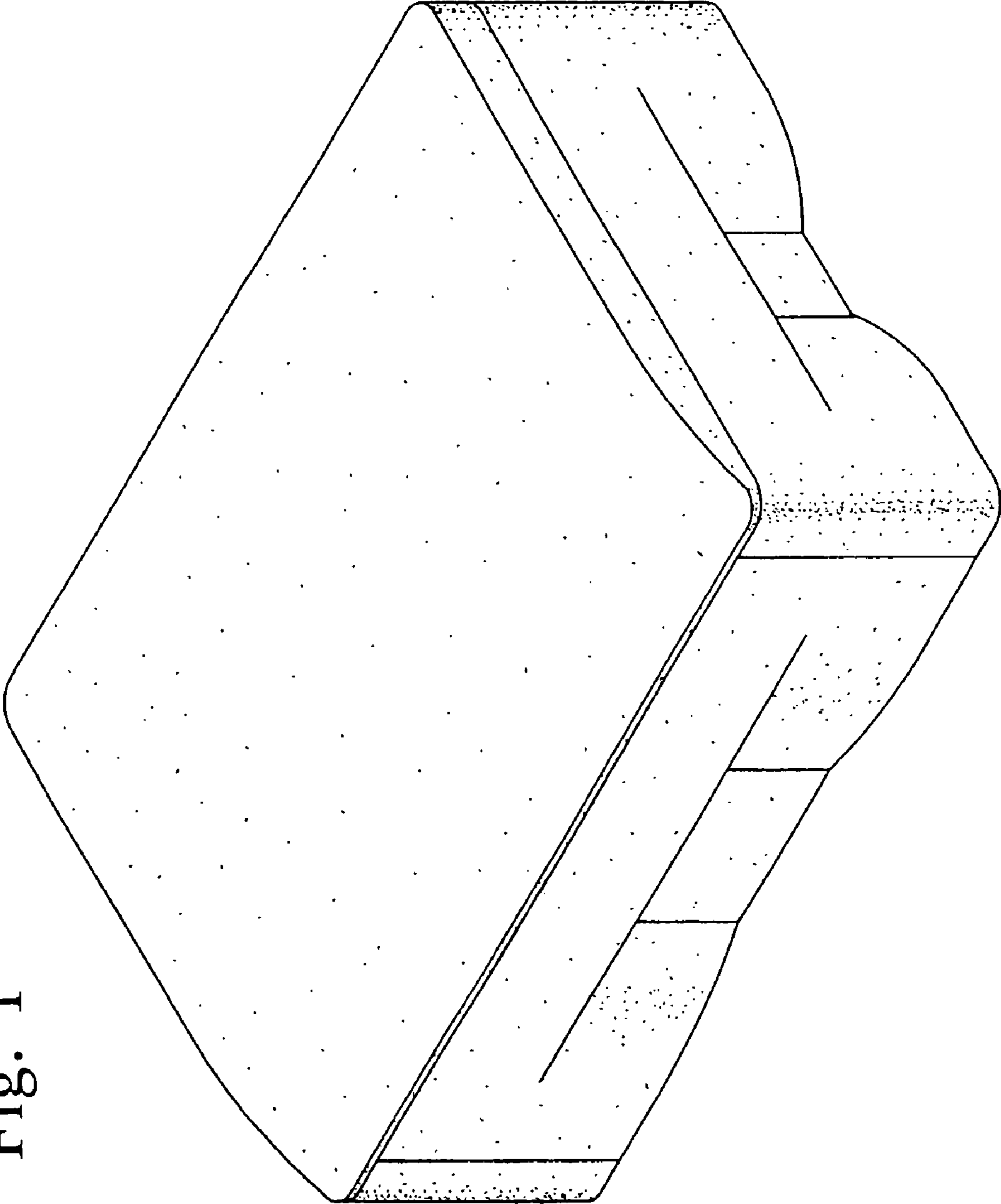

Fig. 2

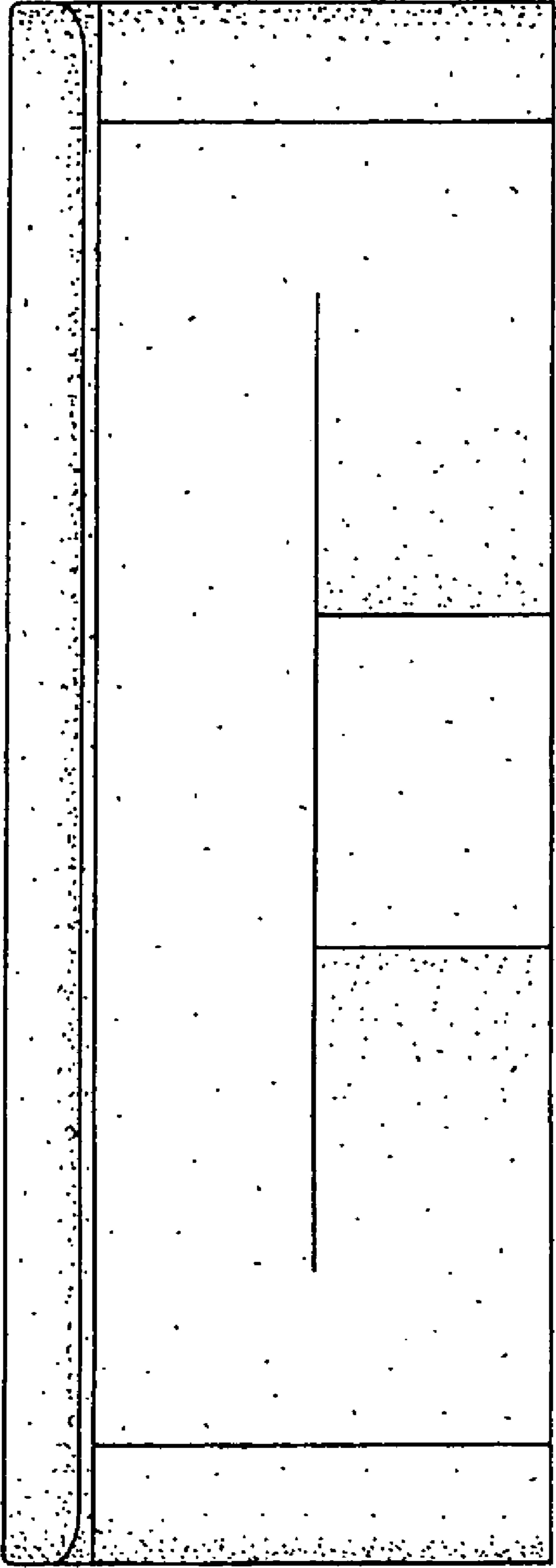

Fig. 3

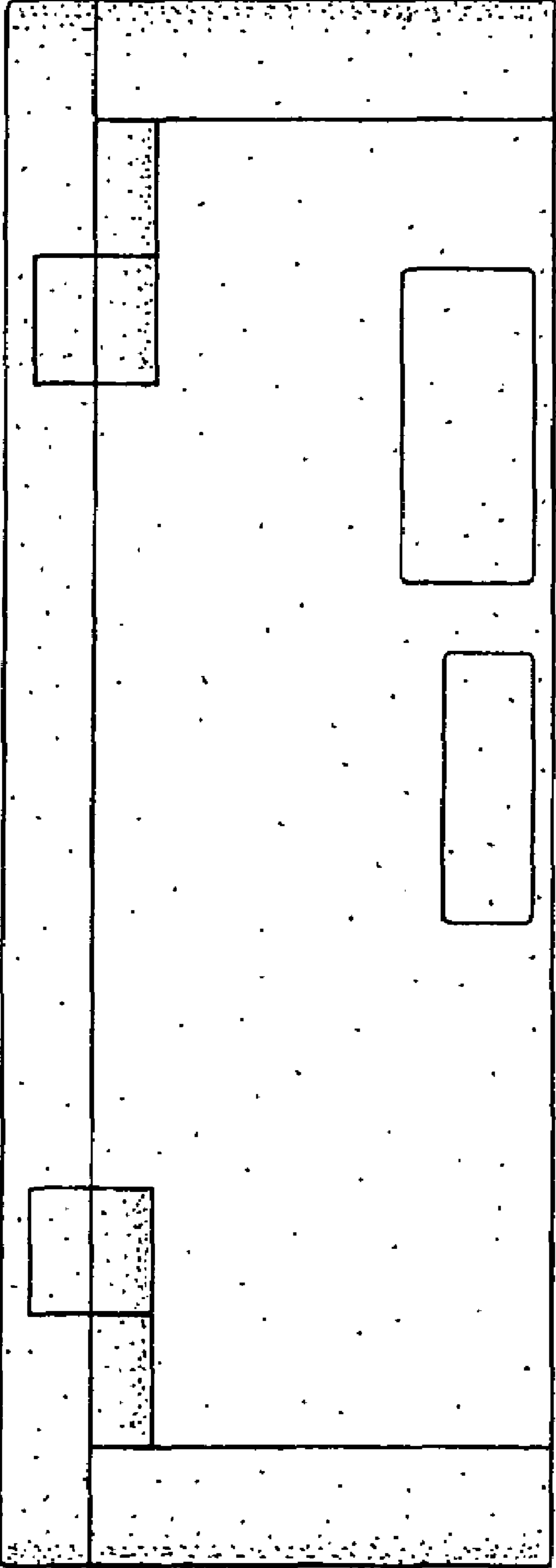

Fig. 4

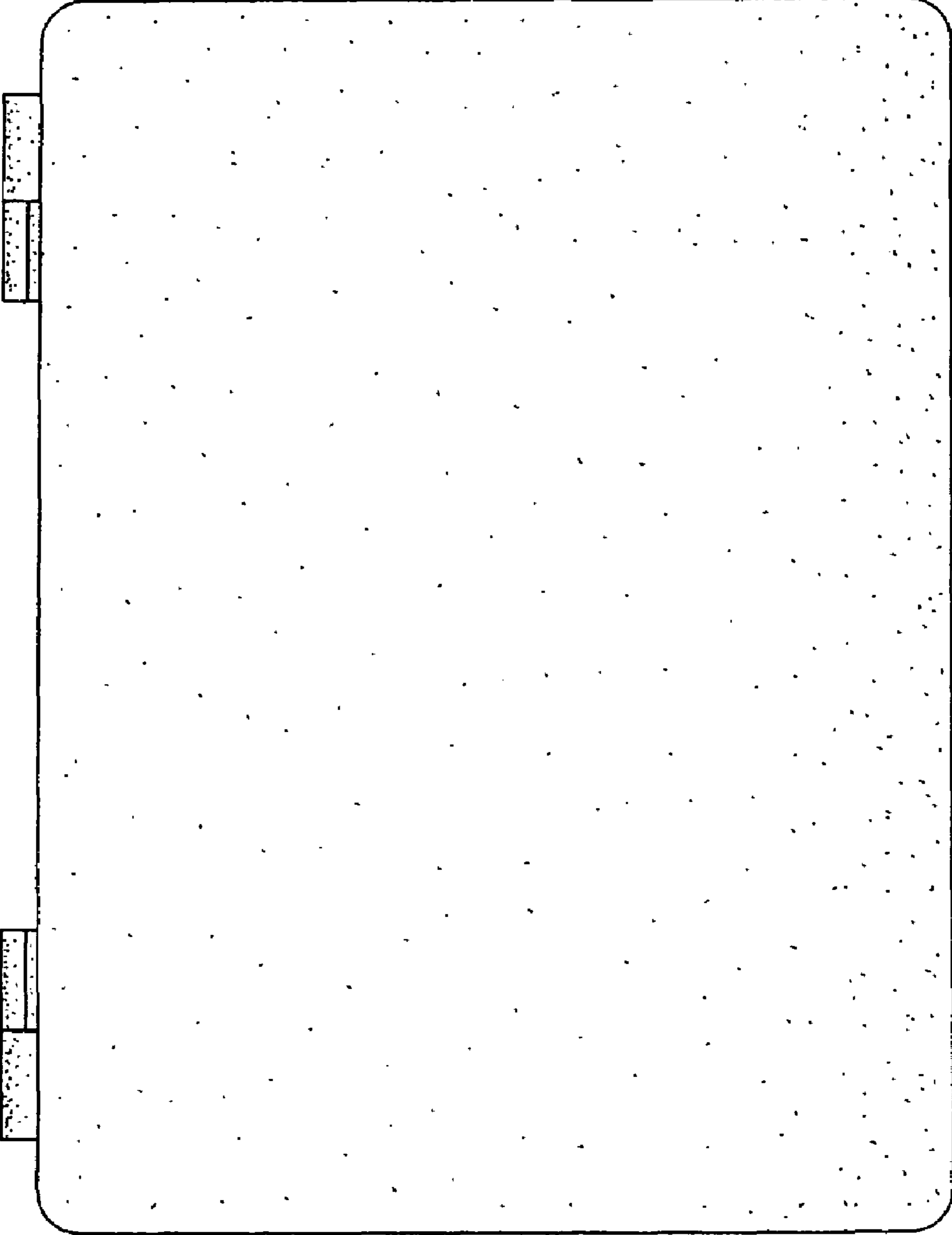

Fig. 5

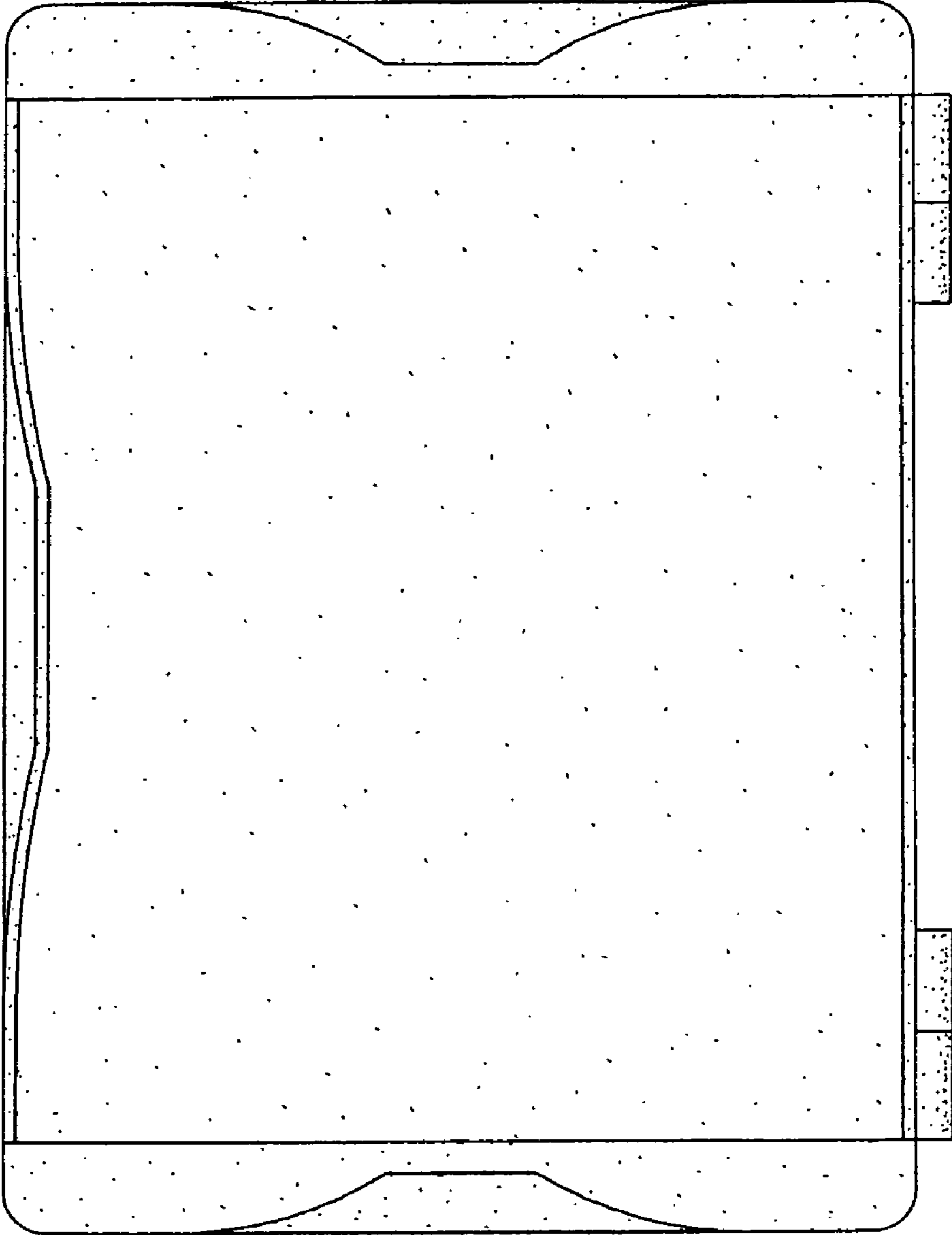

Fig. 7

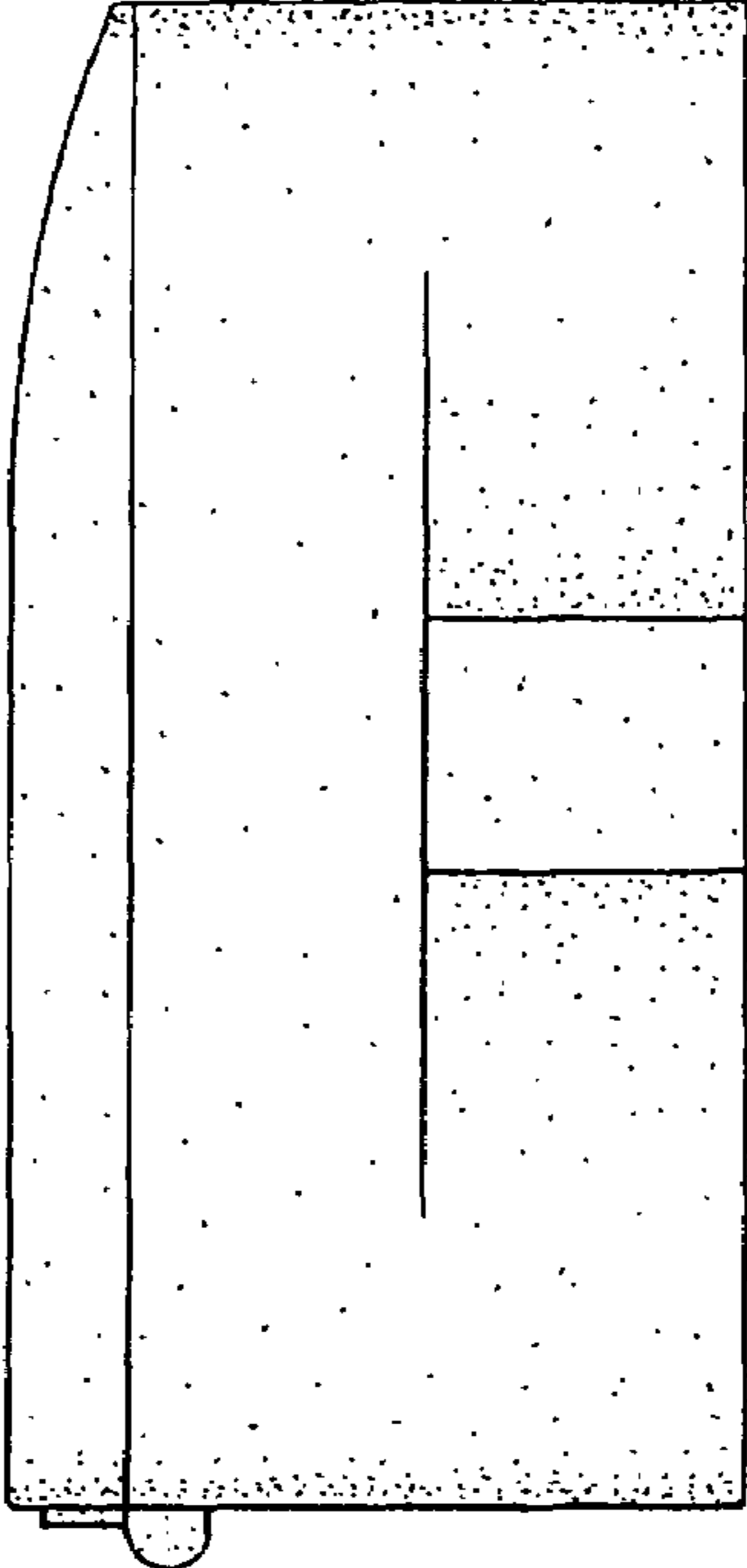
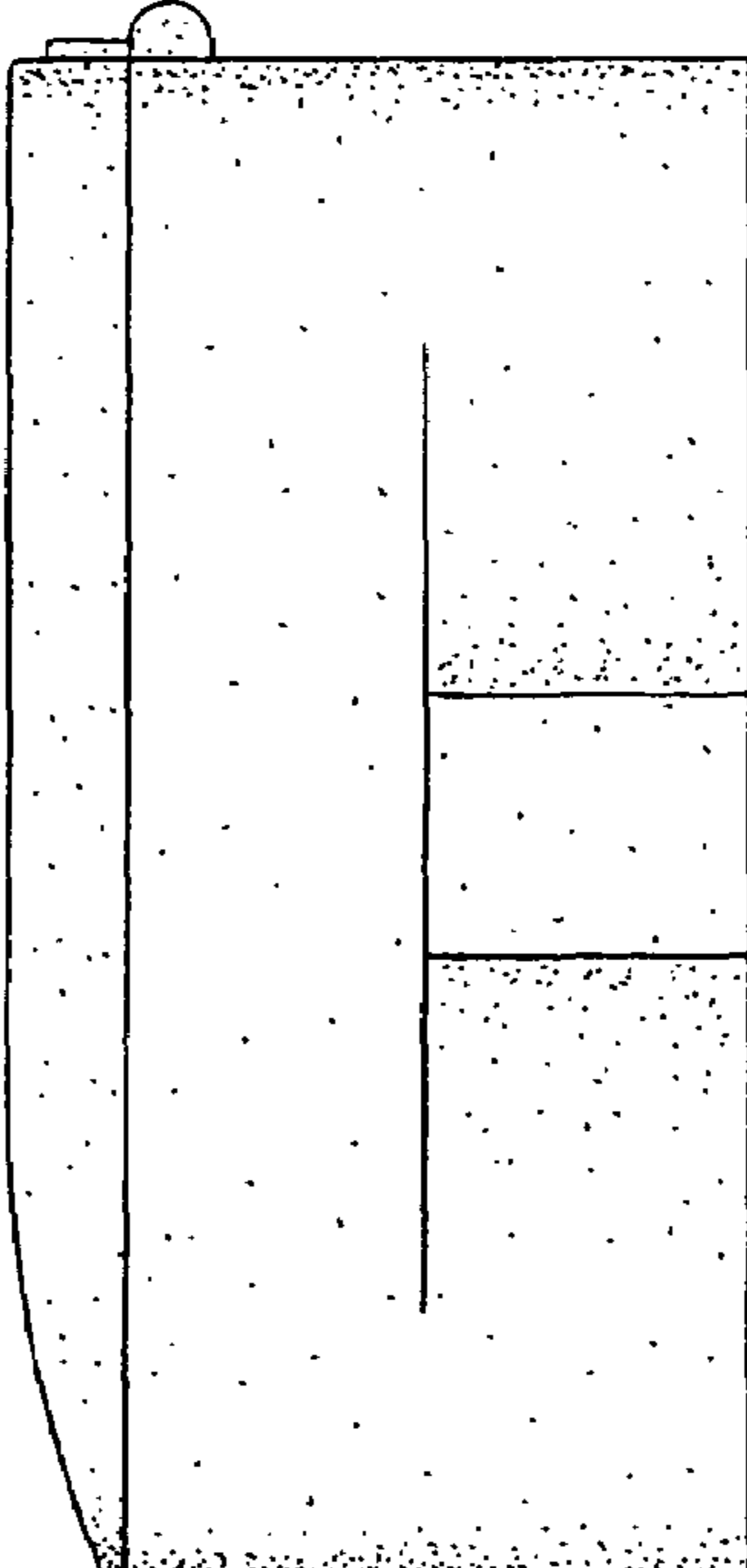

Fig. 6



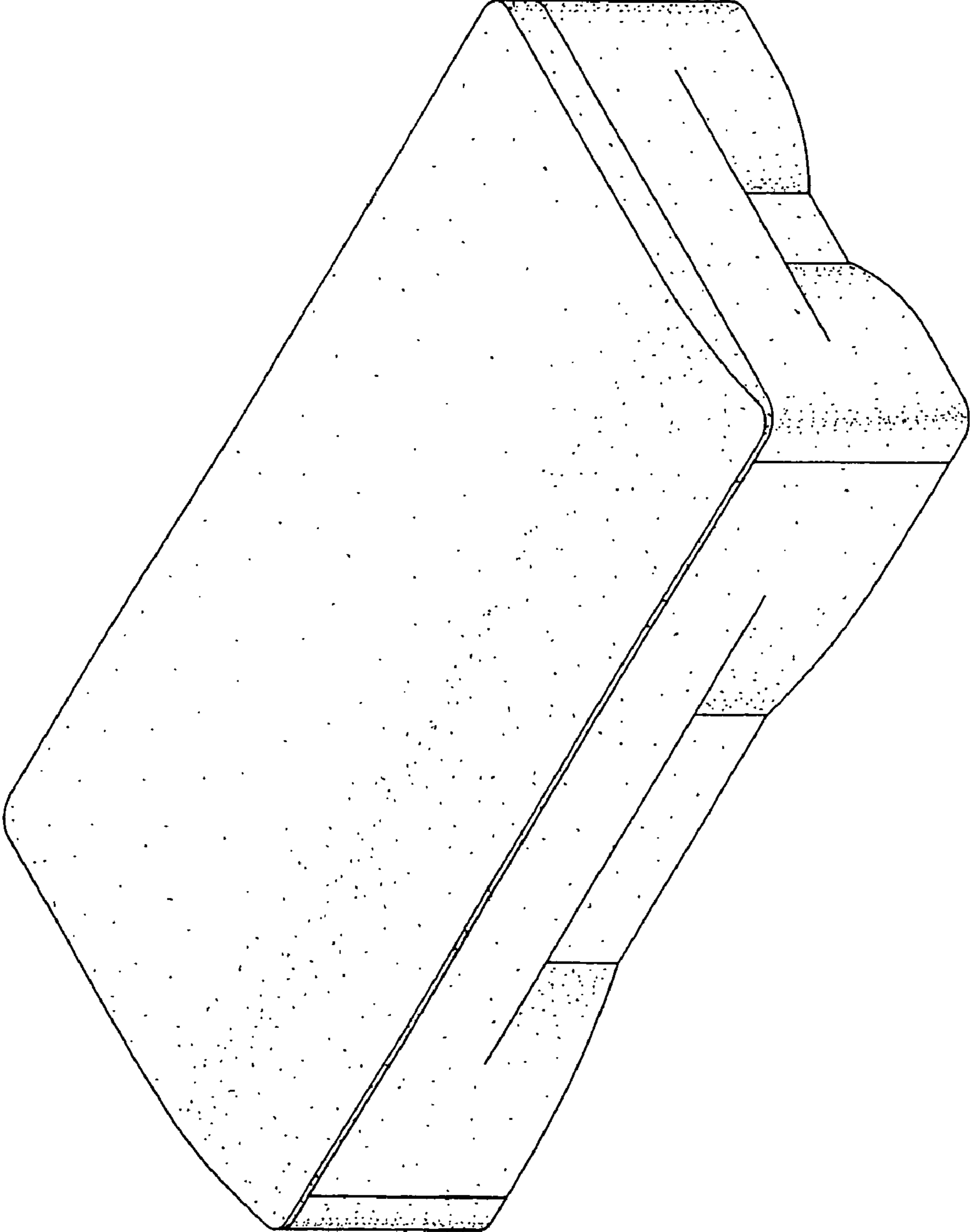

Fig. 8

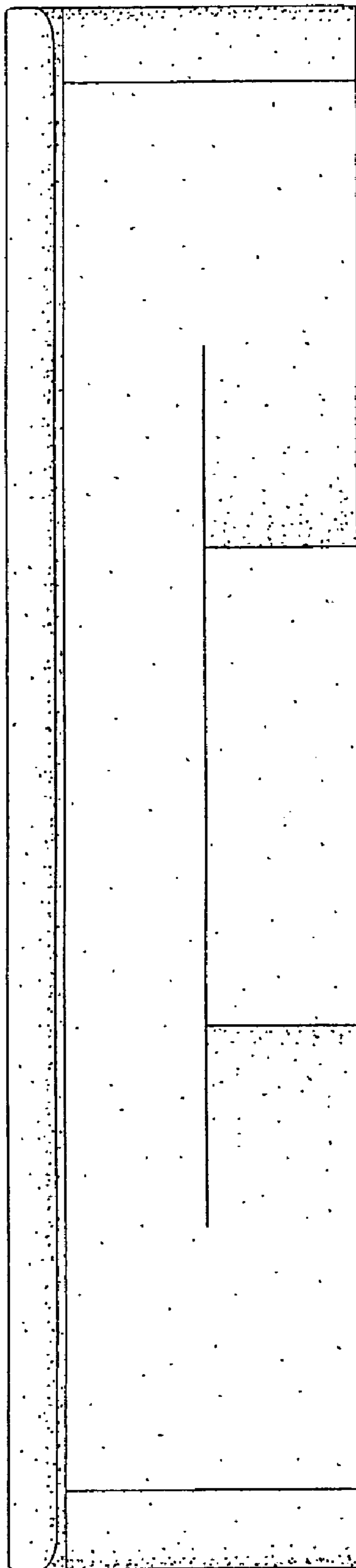

Fig. 9

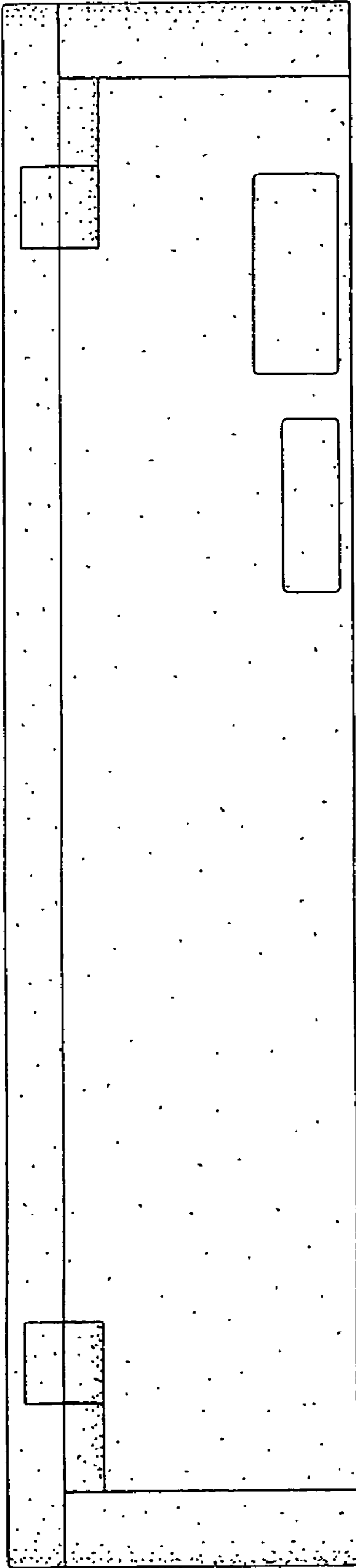

Fig. 10

Fig. 11

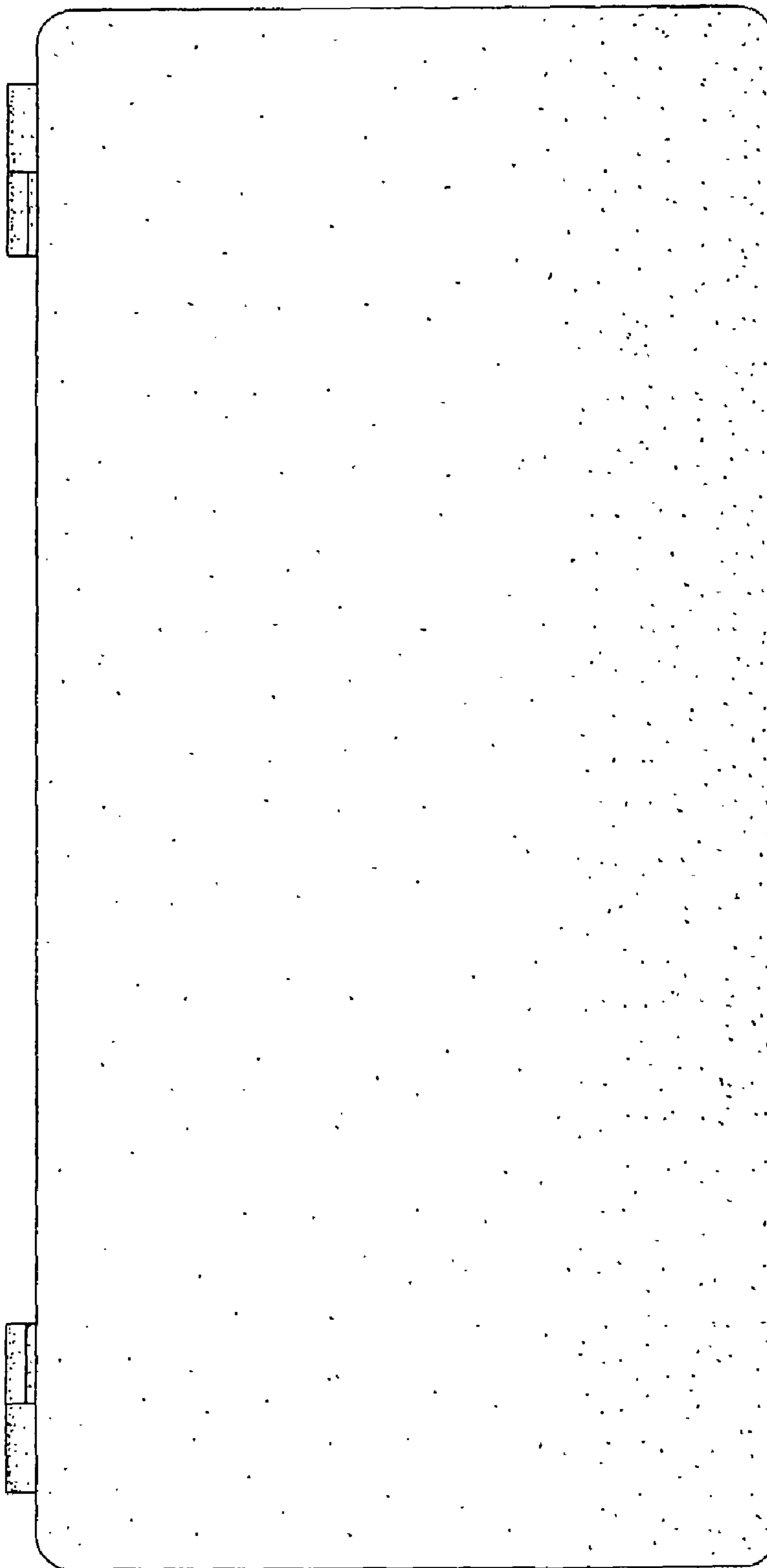

Fig. 12

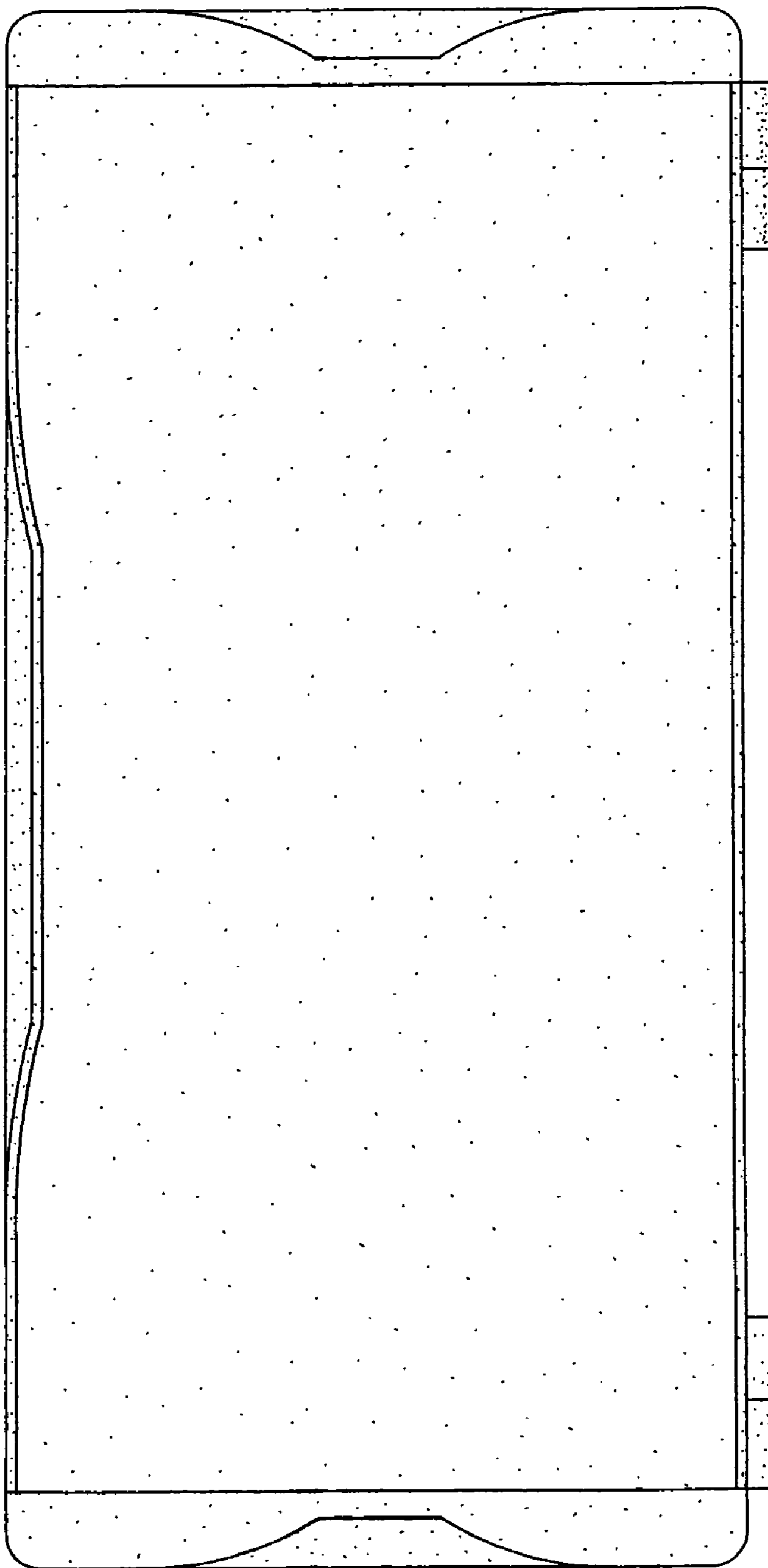

Fig. 14

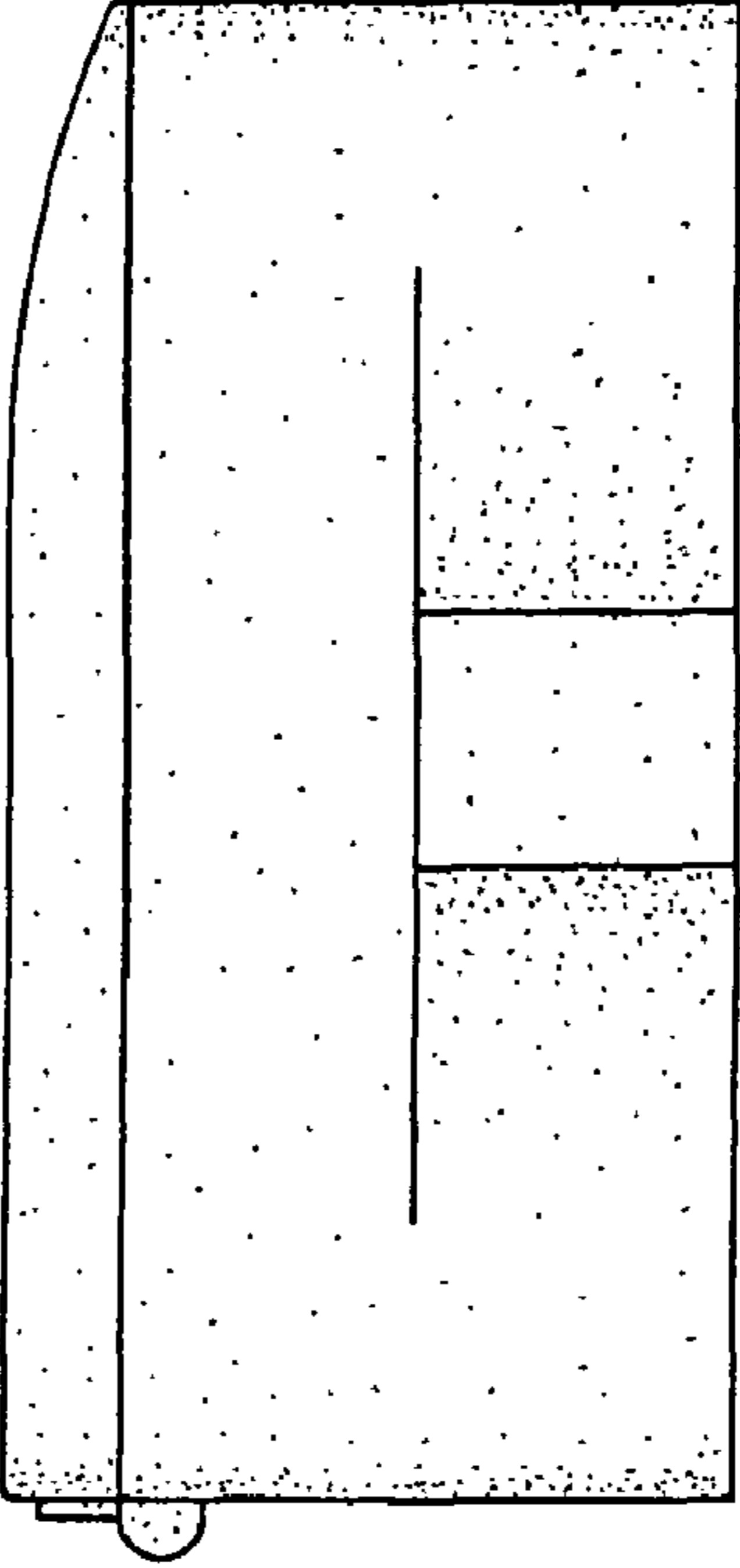

Fig. 13

