



US00D600455S

(12) **United States Design Patent**  
**Nell**

(10) **Patent No.:** **US D600,455 S**

(45) **Date of Patent:** **\*\* Sep. 22, 2009**

(54) **DIGITAL PHOTO ALBUM**

(57) **CLAIM**

(76) **Inventor:** **Dominika Nell**, Petrska ullce 1135/10,  
Praha 1-Nove Mesto (CZ) 110 00

The ornamental design for a digital photo album, as shown  
and described.

(\*\*) **Term:** **14 Years**

**DESCRIPTION**

(21) **Appl. No.:** **29/309,756**

FIG. 1 is a front perspective view showing my new design for  
a digital photo album,

(22) **Filed:** **Oct. 3, 2008**

FIG. 2 is a rear perspective view thereof,

(30) **Foreign Application Priority Data**

Apr. 3, 2008 (EM) ..... 000908629 0001

FIG. 3 is a right side view thereof,

(51) **LOC (9) Cl.** ..... **06-07**

FIG. 4 is a left side view thereof,

(52) **U.S. Cl.** ..... **D6/308; D6/310; D14/371**

FIG. 5 is a front view thereof,

(58) **Field of Classification Search** ..... D6/300,  
D6/308, 310, 311; 40/721, 700, 768, 717,  
40/714; D14/371, 372, 448, 449, 450, 375,  
D14/374, 381, 382, 336, 337, 132, 130; D10/15,  
D10/24, 75, 2; D19/26, 59, 2  
See application file for complete search history.

FIG. 6 is a rear view thereof,

FIG. 7 is a top view thereof,

FIG. 8 is a bottom view thereof,

FIG. 9 is a front perspective view thereof, while lying flat,

FIG. 10 is right side view thereof, while lying flat,

FIG. 11 is a left side view thereof, while lying flat,

FIG. 12 is a front view thereof, while lying flat,

FIG. 13 is a rear view thereof, while lying flat,

FIG. 14 is a top view thereof, while lying flat,

FIG. 15 is a bottom view thereof, while lying flat,

FIG. 16 is a front perspective view thereof, while closed,

FIG. 17 is a right side view thereof, while closed,

FIG. 18 is a left side view thereof, while closed,

FIG. 19 is a front view thereof, while closed,

FIG. 20 is a rear view thereof, while closed,

FIG. 21 is a top view thereof, while closed; and,

FIG. 22 is a bottom view thereof, while closed.

(56) **References Cited**

**U.S. PATENT DOCUMENTS**

D283,086 S *	3/1986	Weinhart	.....	D6/308
D283,853 S *	5/1986	Wistrand	.....	D6/308
D444,176 S *	6/2001	Leslie	.....	D19/59
D496,662 S *	9/2004	Borsboom	.....	D14/371
D545,359 S *	6/2007	Bramhall	.....	D19/2
D558,460 S *	1/2008	Yu et al.	.....	D6/308
D585,399 S *	1/2009	Hwang	.....	D14/130
D589,014 S *	3/2009	Zhan	.....	D14/132

\* cited by examiner

*Primary Examiner*—Caron Veynar

*Assistant Examiner*—Sydney R Buffalow

(74) *Attorney, Agent, or Firm*—Jacobson Holman PLLC

**1 Claim, 14 Drawing Sheets**

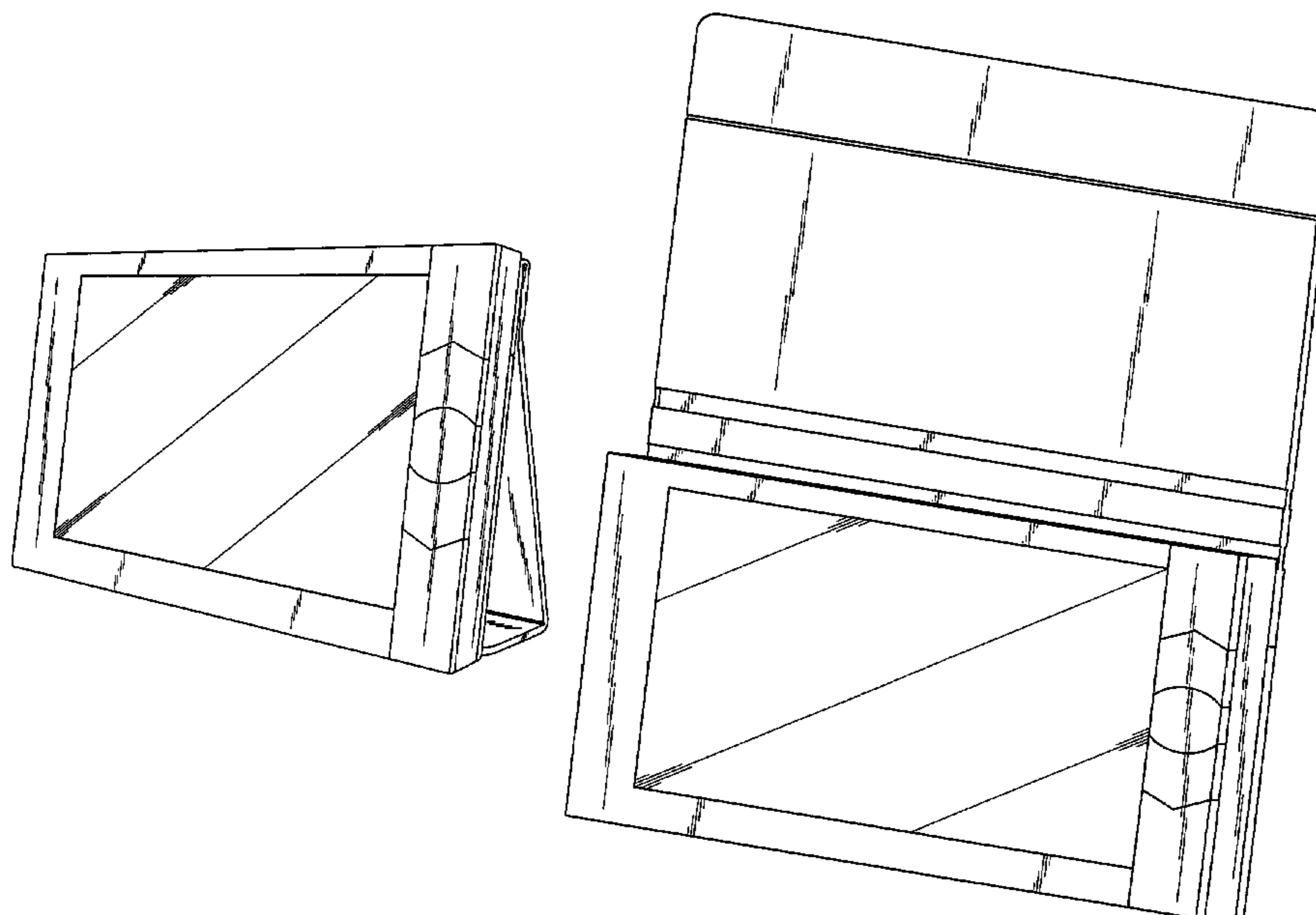

FIG. 1

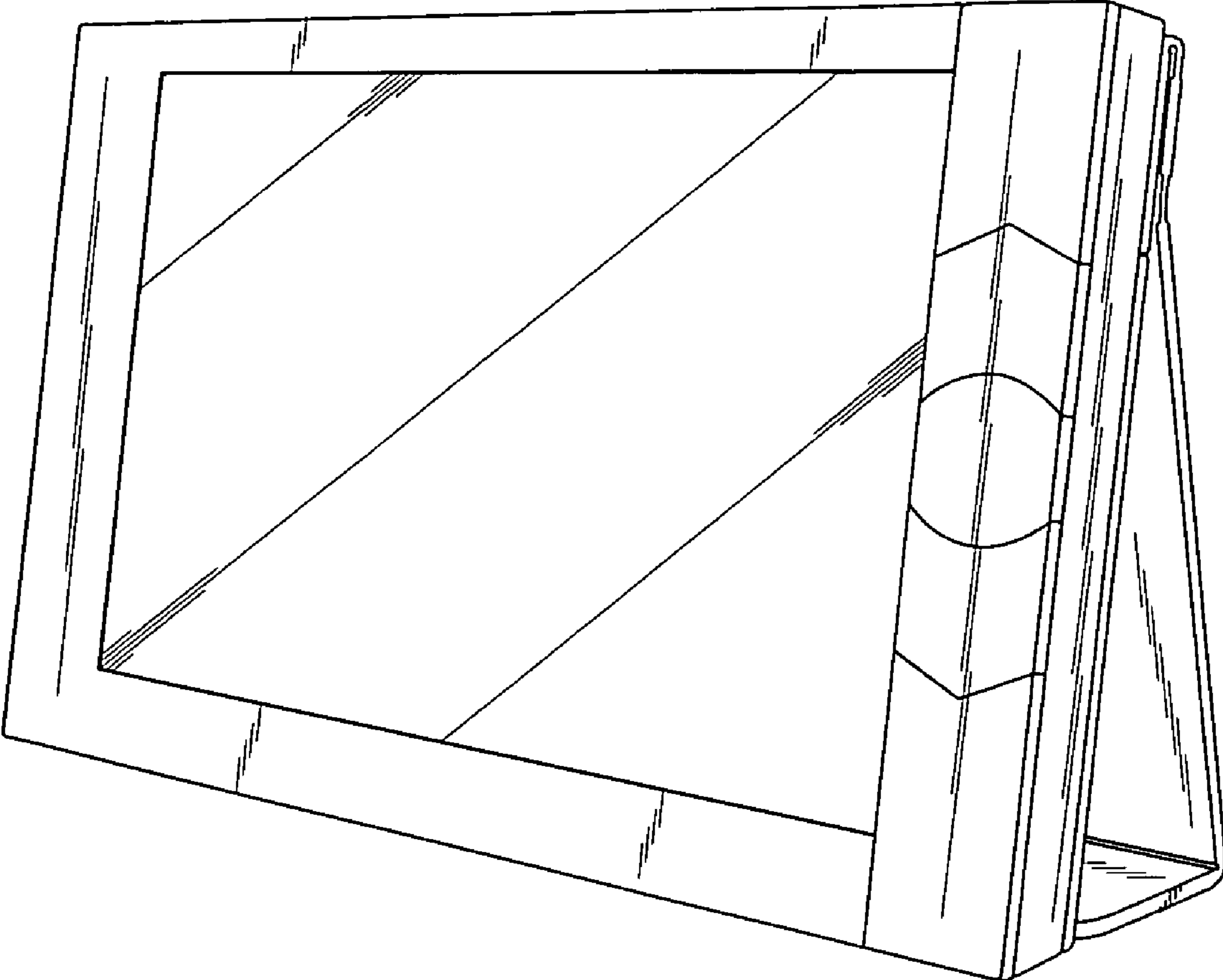

FIG. 2

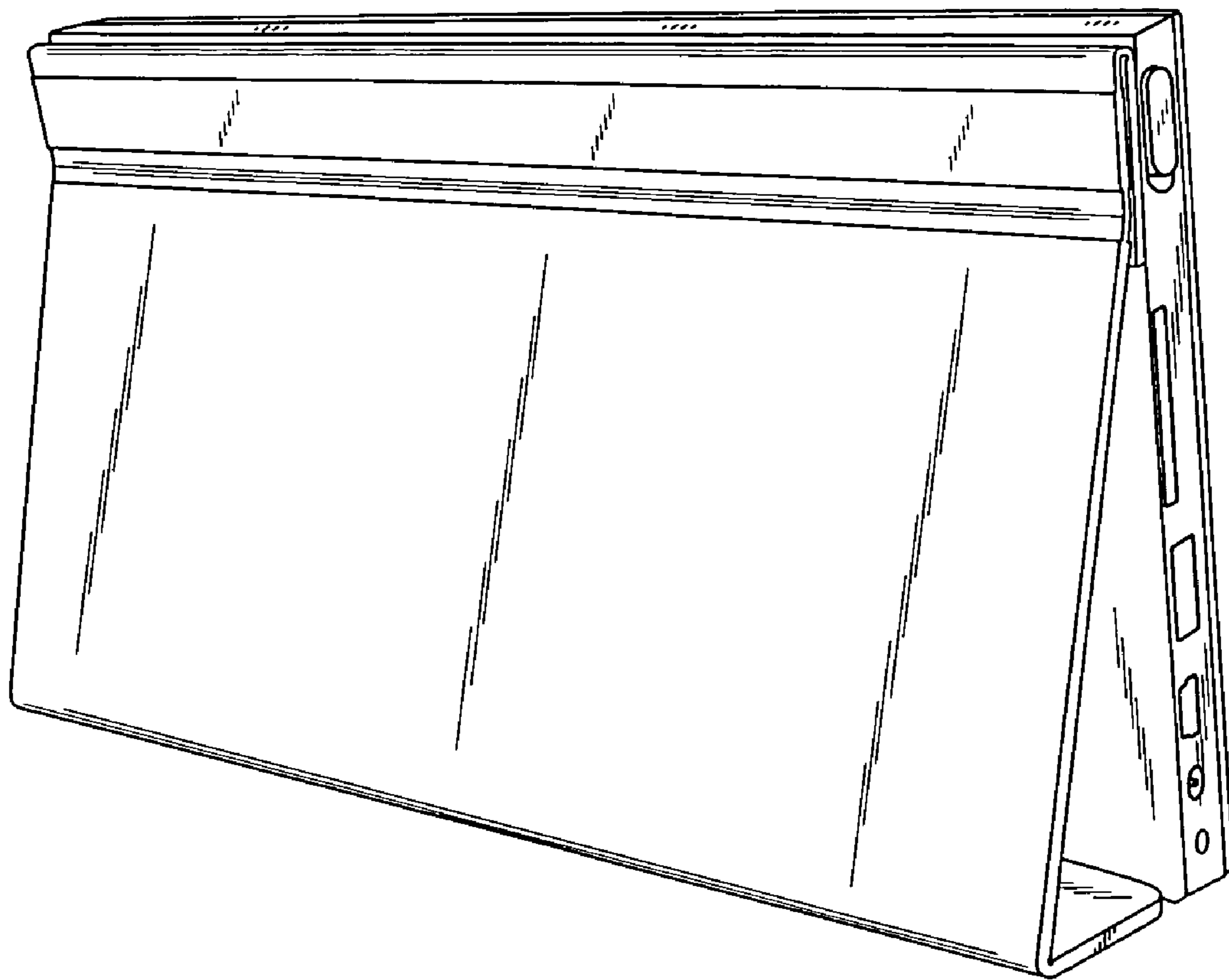

FIG. 3

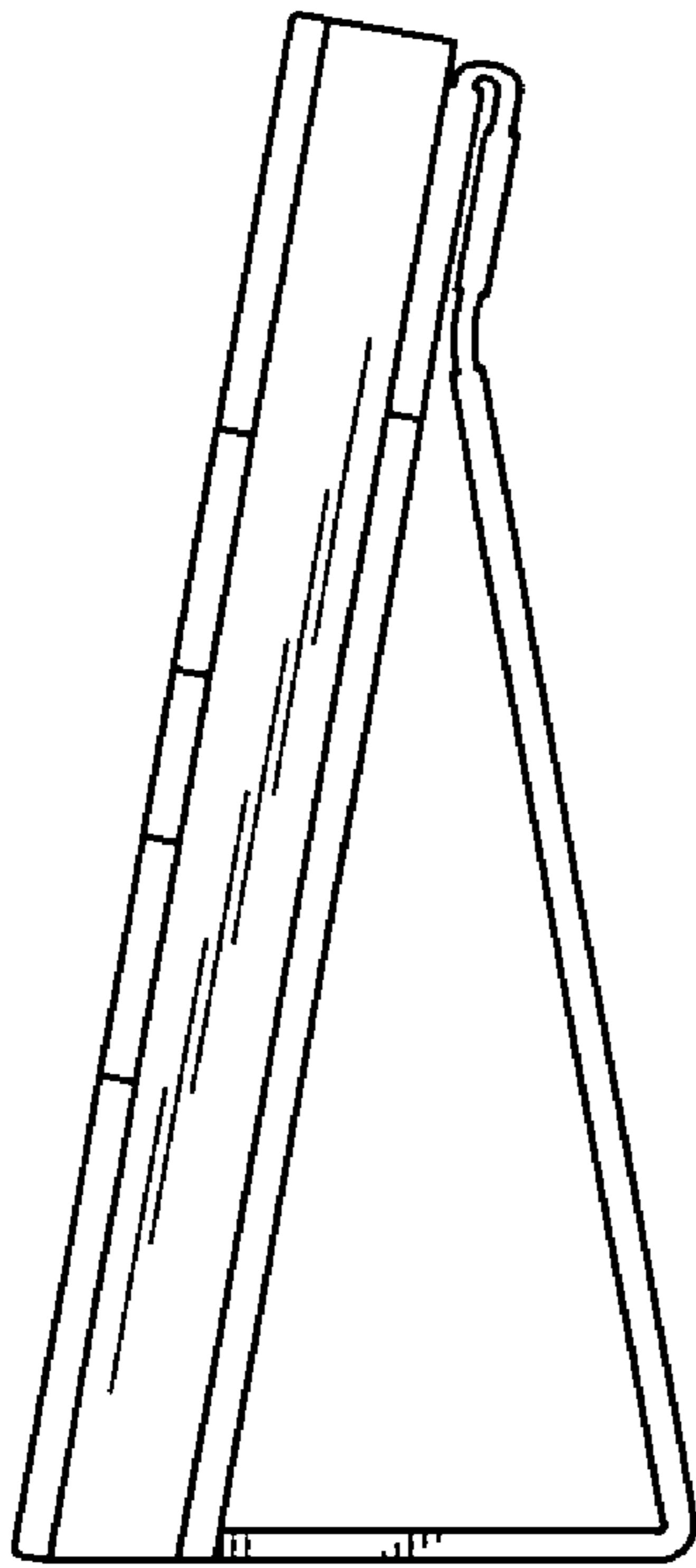

FIG. 4

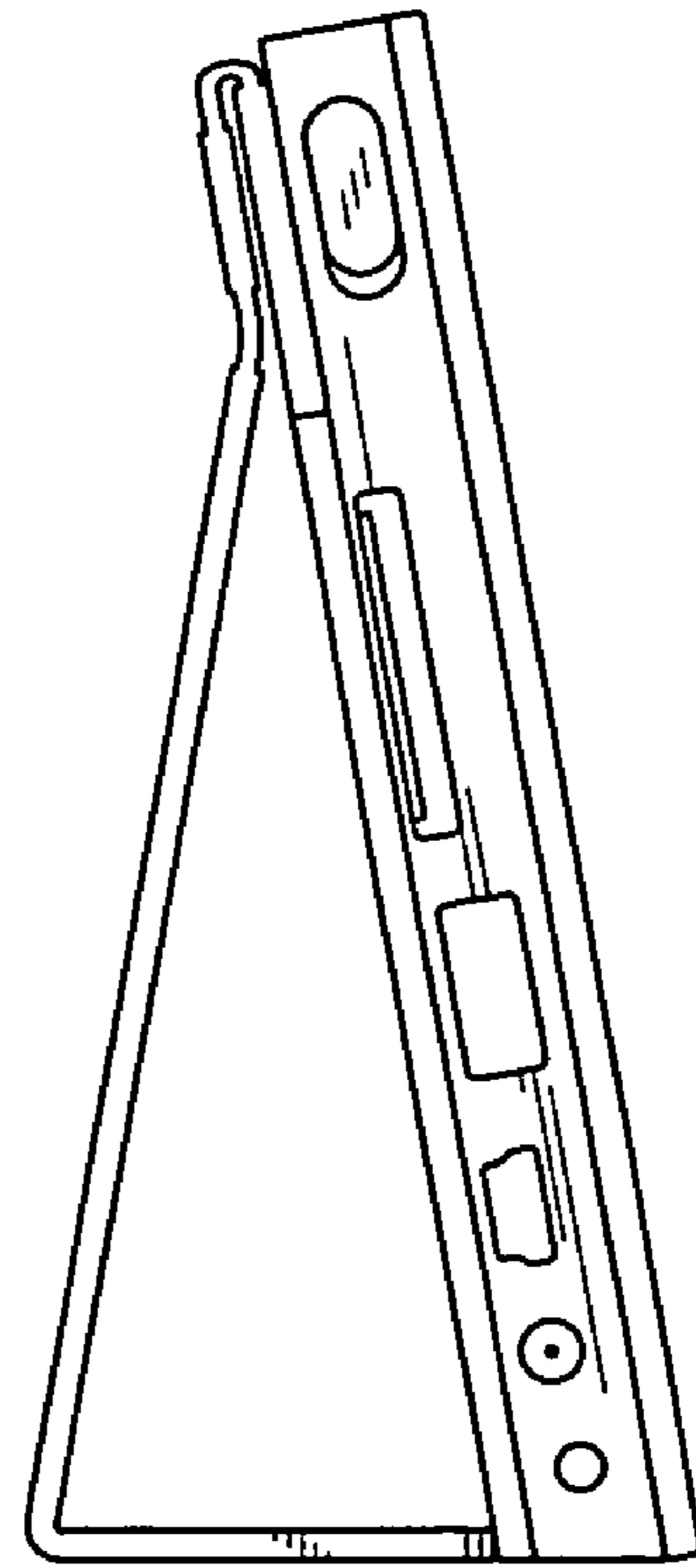

FIG. 5

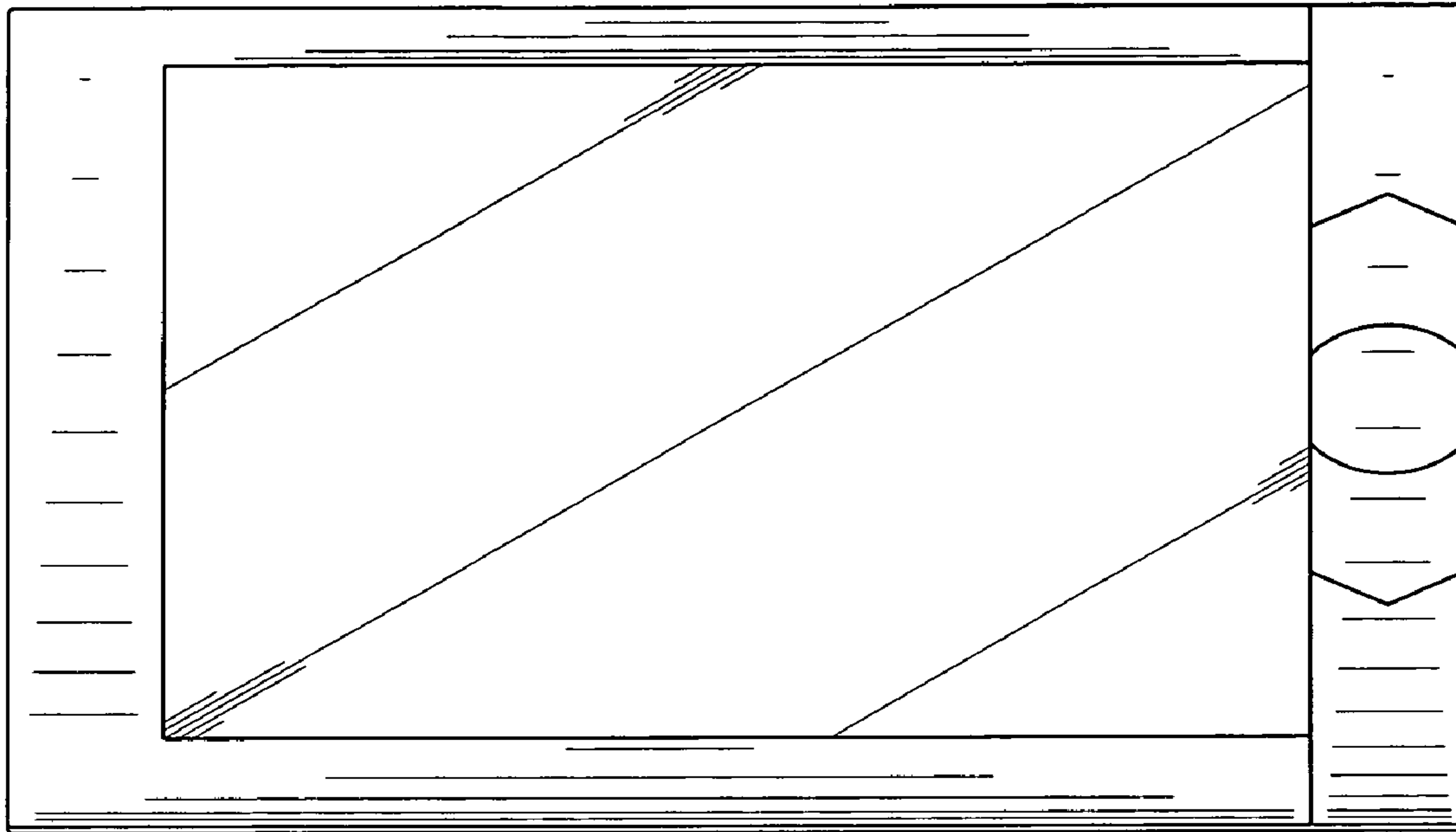

FIG. 6

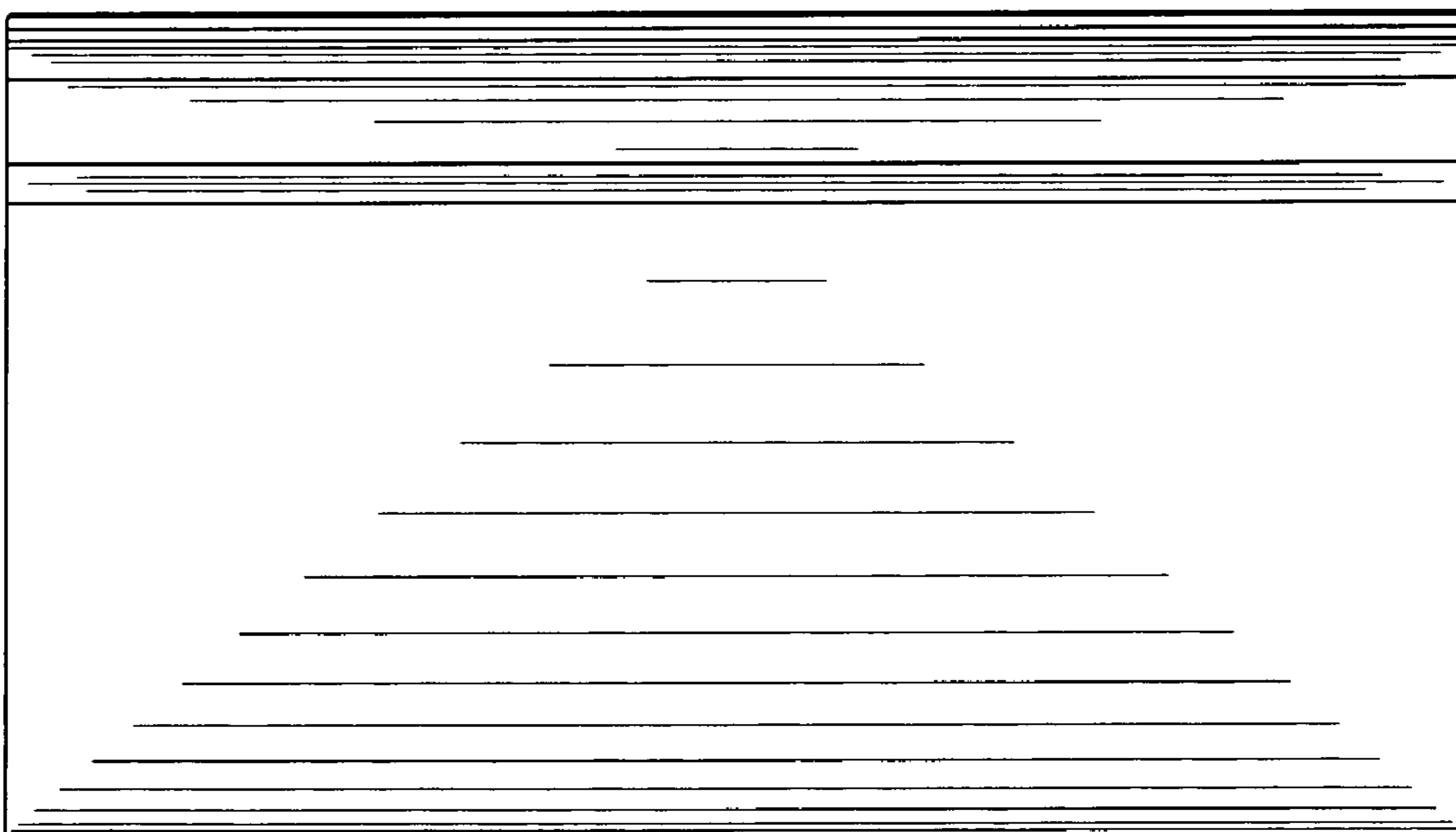

FIG. 7



FIG. 8

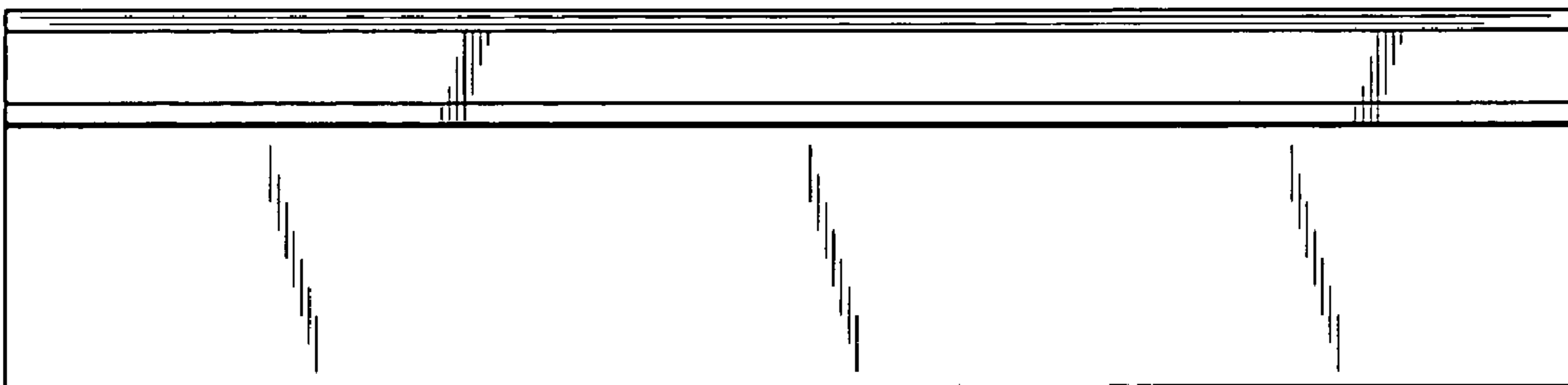

FIG. 9

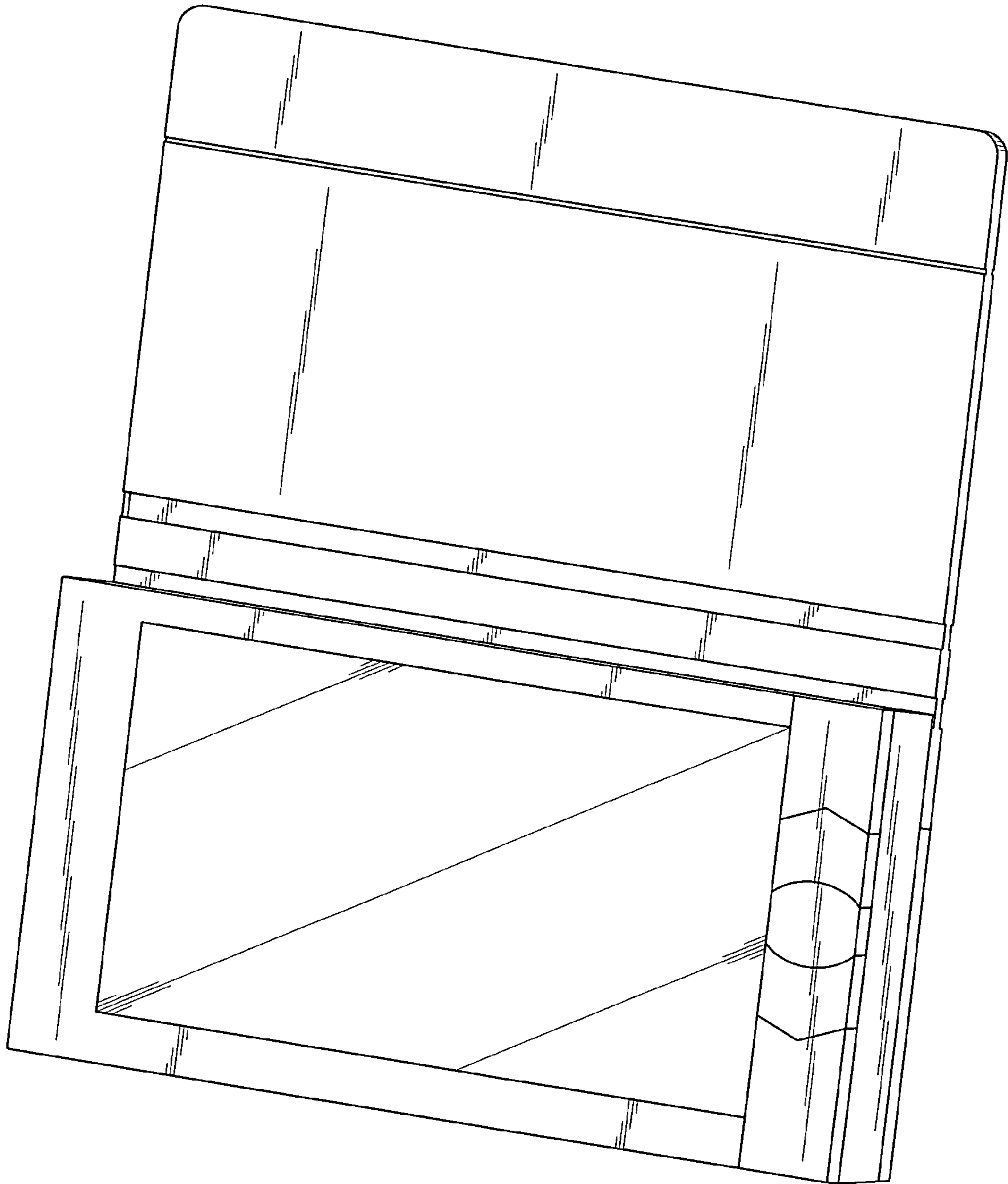

FIG. 10



FIG. 11

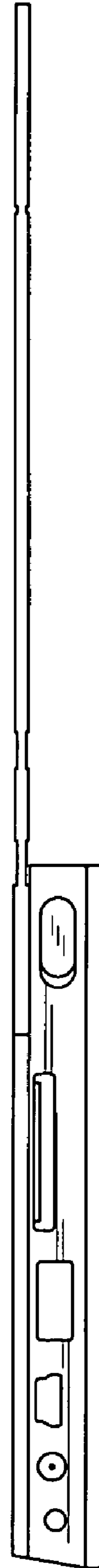



FIG. 12

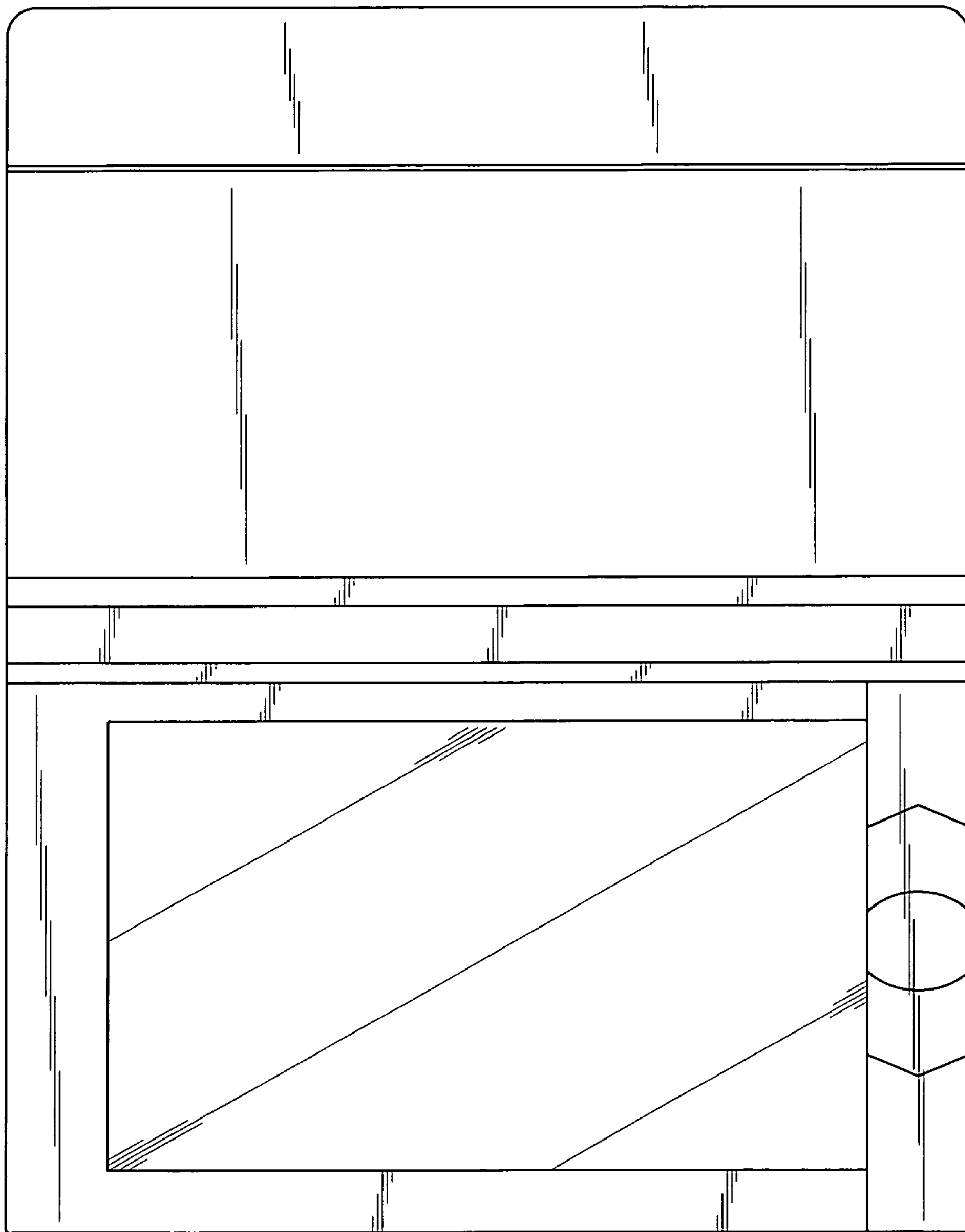
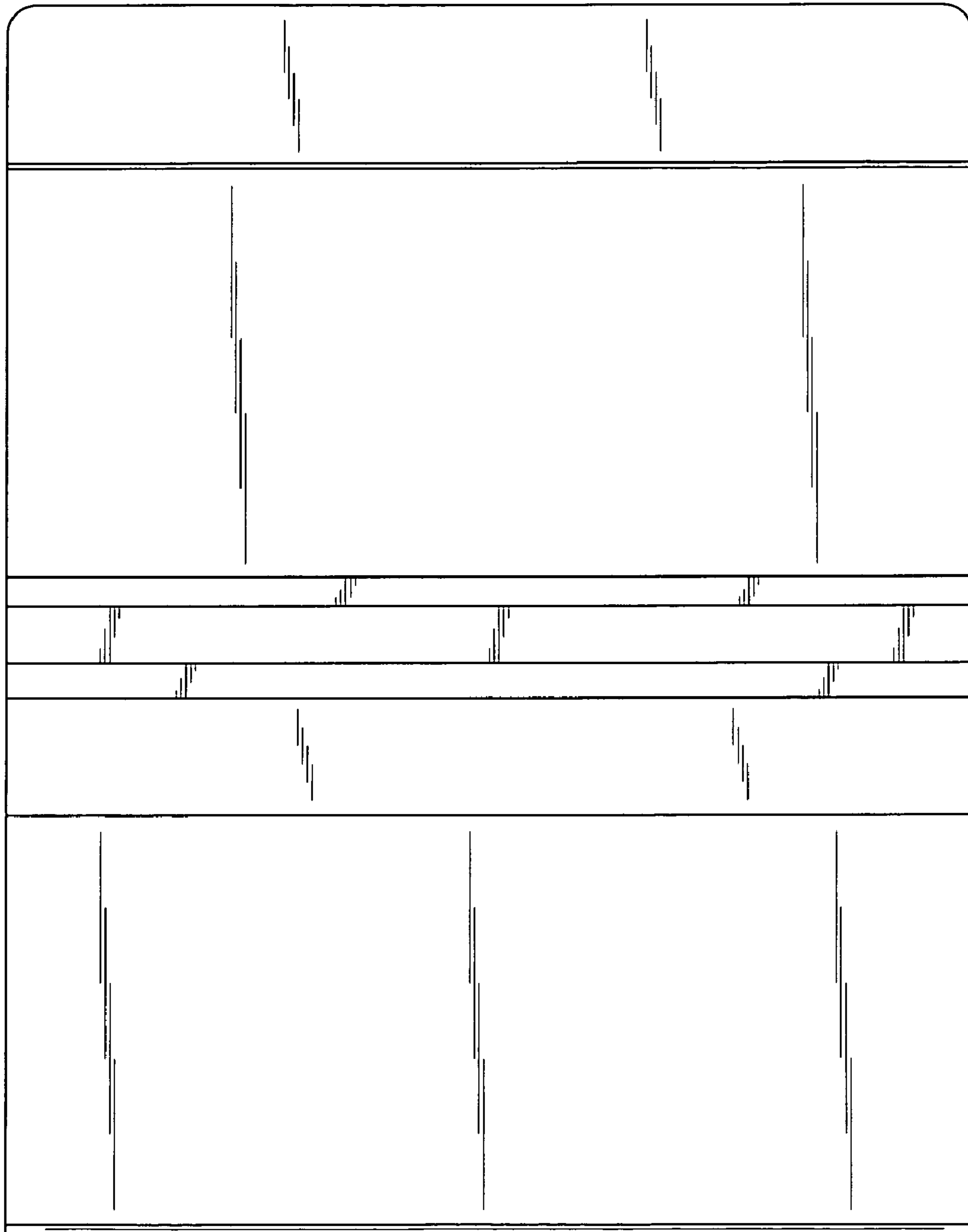
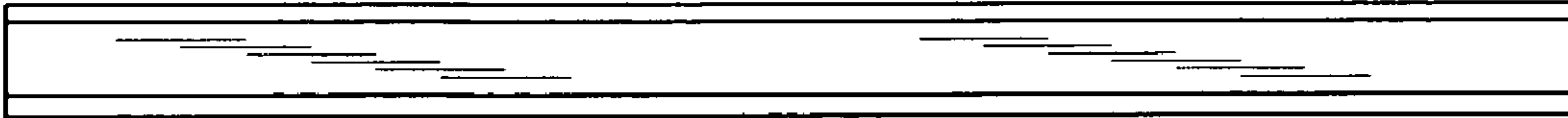

FIG. 13



**FIG. 14**



**FIG. 15**

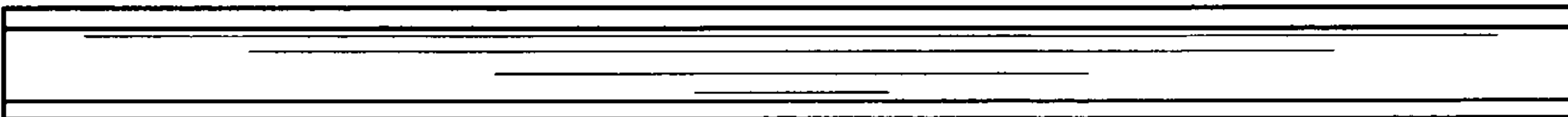

FIG. 16

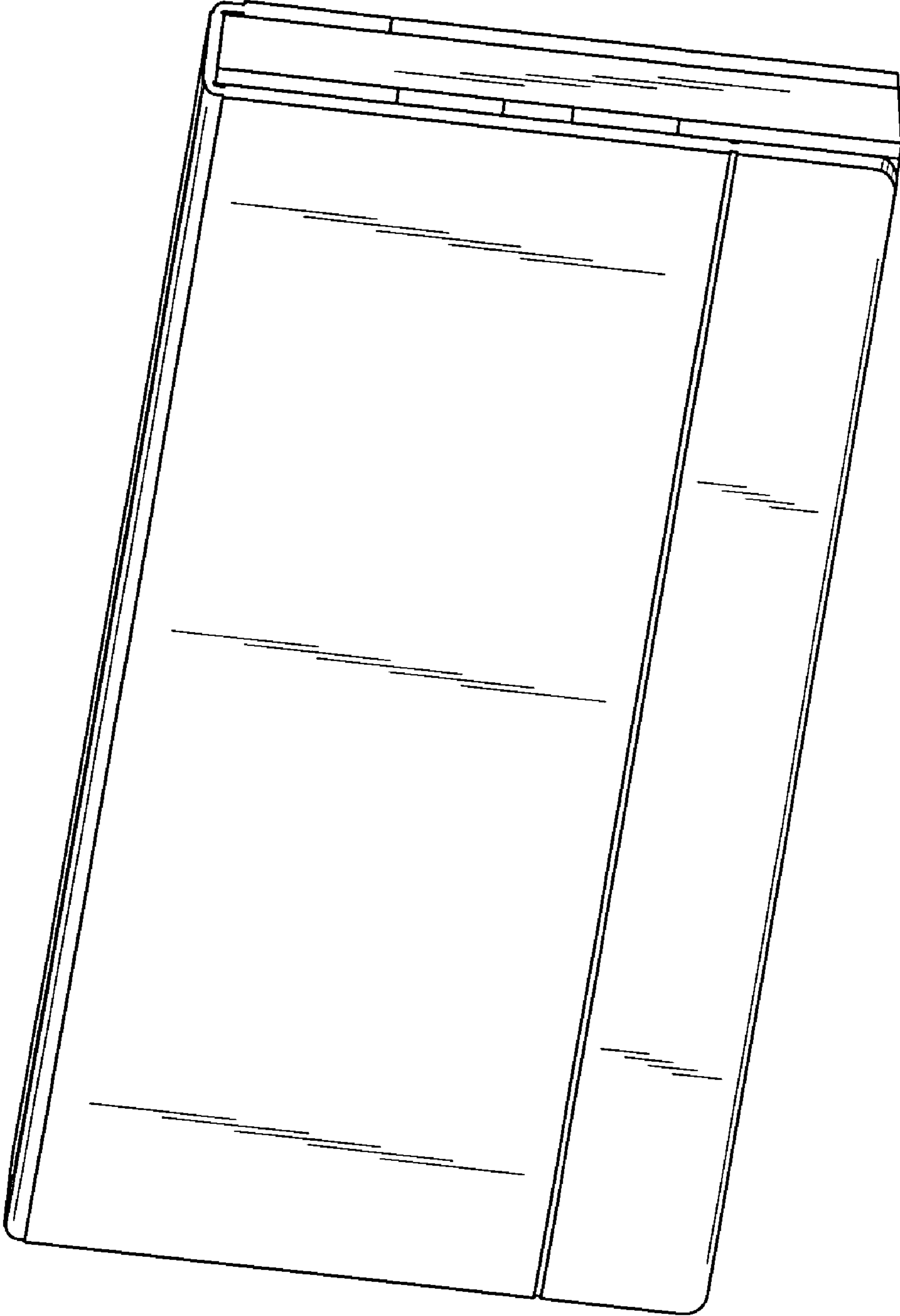

FIG. 17

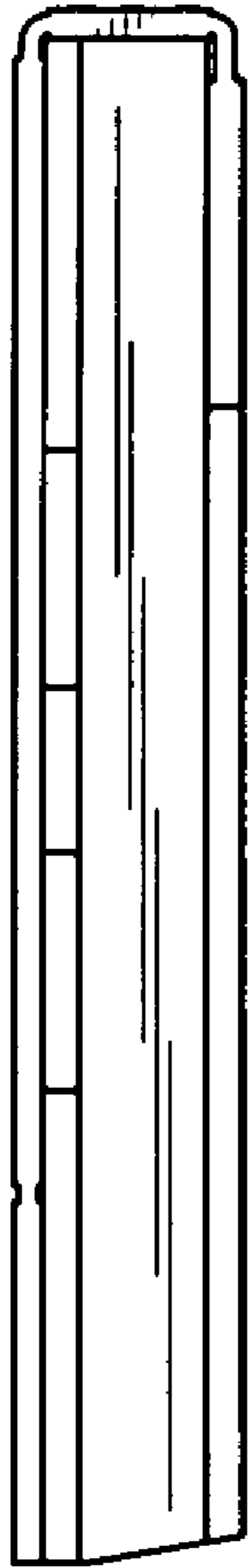

FIG. 18

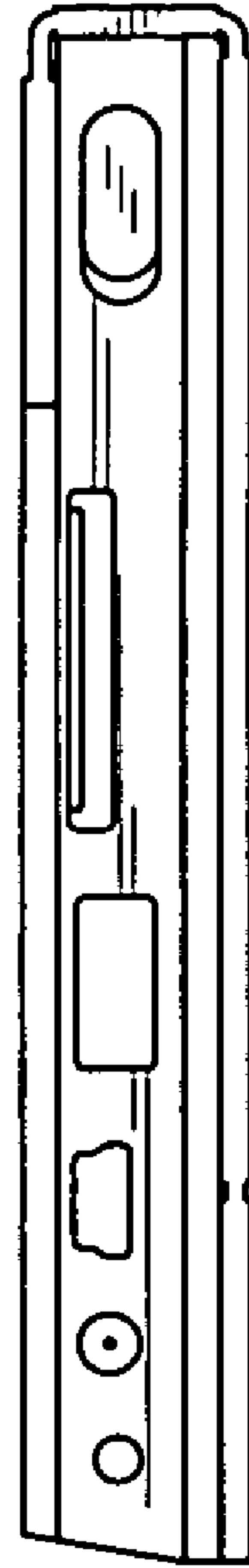

FIG. 19

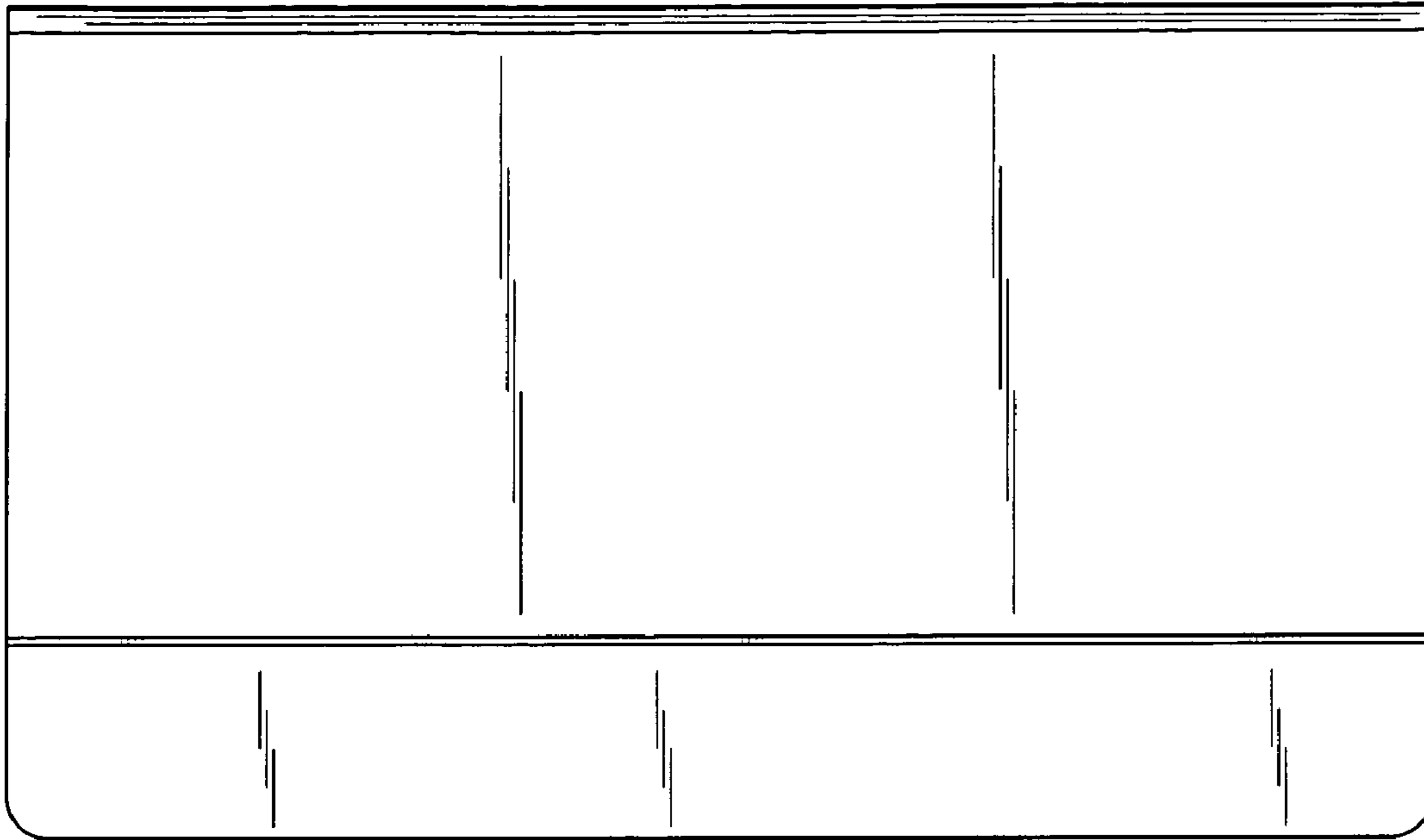

FIG. 20

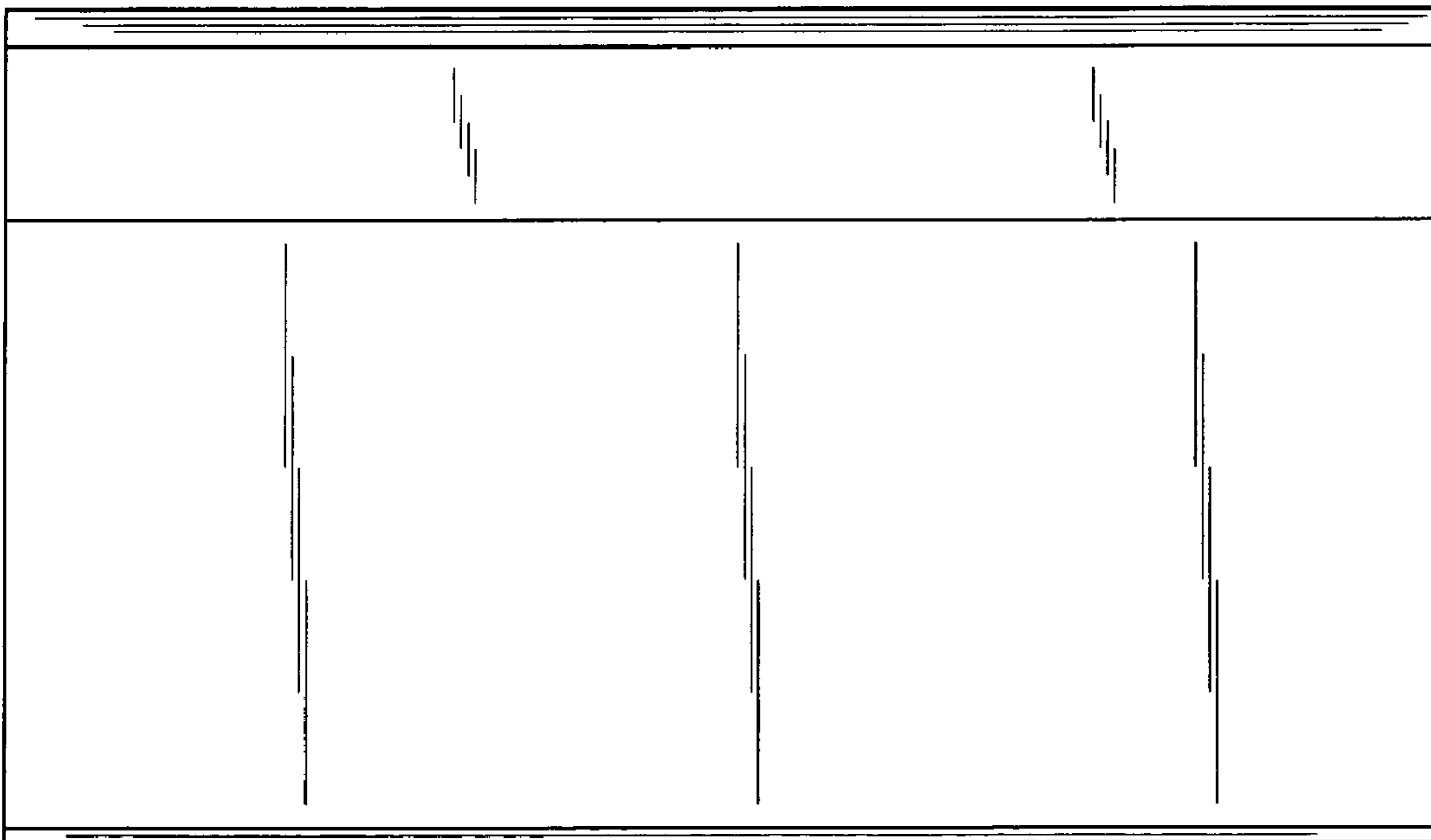

FIG. 21

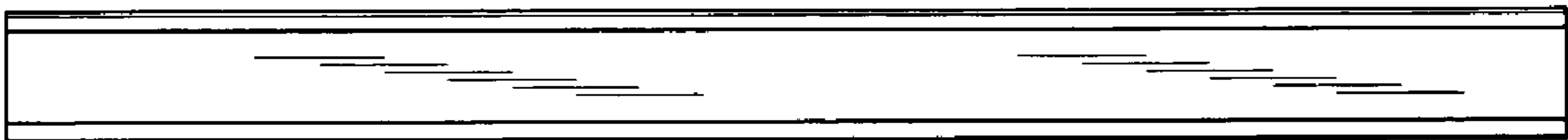

FIG. 22

