



US00D600452S

(12) **United States Design Patent**
Gonzalez

(10) **Patent No.:** **US D600,452 S**
(45) **Date of Patent:** **** Sep. 22, 2009**

(54) **HANDBAG**

(75) Inventor: **Alvaro Gonzalez**, Florence (IT)

(73) Assignee: **J. Choo Limited**, London (GB)

(**) Term: **14 Years**

(21) Appl. No.: **29/308,903**

(22) Filed: **Jul. 14, 2008**

(30) **Foreign Application Priority Data**

Jan. 15, 2008 (EM) 000862354-0009

(51) **LOC (9) Cl.** **03-01**

(52) **U.S. Cl.** **D3/345**

(58) **Field of Classification Search** D3/232-233,
D3/240-246, 318 K, 322, 324; 150/100,
150/103-110, 113-114, 116, 118-119
See application file for complete search history.

(56) **References Cited**

U.S. PATENT DOCUMENTS

D543,026 S * 5/2007 Gonzalez D3/243
D580,165 S * 11/2008 Pavlou D3/245

OTHER PUBLICATIONS

U.S. Appl. No. 29/308,915, filed Jul. 14, 2008; First named inventor Gonzalez.

* cited by examiner

Primary Examiner—Holly H Baynham
(74) *Attorney, Agent, or Firm*—Fross Zelnick Lehrman & Zissu, P.C.; Lawrence E. Apolzon, Esq.

(57) **CLAIM**

The ornamental design for a handbag, as shown and described.

DESCRIPTION

FIG. 1 is a front perspective view of a handbag showing my new design;

FIG. 2 is a front view of the handbag shown in FIG. 1;

FIG. 3 is a rear view of the handbag shown in FIG. 1;

FIG. 4 is a left side view of the handbag shown in FIG. 1;

FIG. 5 is a right side view of the handbag shown in FIG. 1;

FIG. 6 is a top view of the handbag shown in FIG. 1;

FIG. 7 is a bottom view of the handbag shown in FIG. 1;

FIG. 8 is a front perspective view of an alternative embodiment of the handbag shown in FIG. 1;

FIG. 9 is a front view of the alternative embodiment of the handbag shown in FIG. 8;

FIG. 10 is a rear view of the alternative embodiment of the handbag shown in FIG. 8;

FIG. 11 is a left side view of the alternative embodiment of the handbag shown in FIG. 8;

FIG. 12 is a right side view of the alternative embodiment of the handbag shown in FIG. 8;

FIG. 13 is a top view of the alternative embodiment of the handbag shown in FIG. 8; and,

FIG. 14 is a bottom view of the alternative embodiment of the handbag shown in FIG. 8.

The broken line showing of the zipper, zipper pulls, handles, and bottom seam is for illustrative purposes only and forms no part of the claimed design.

1 Claim, 14 Drawing Sheets

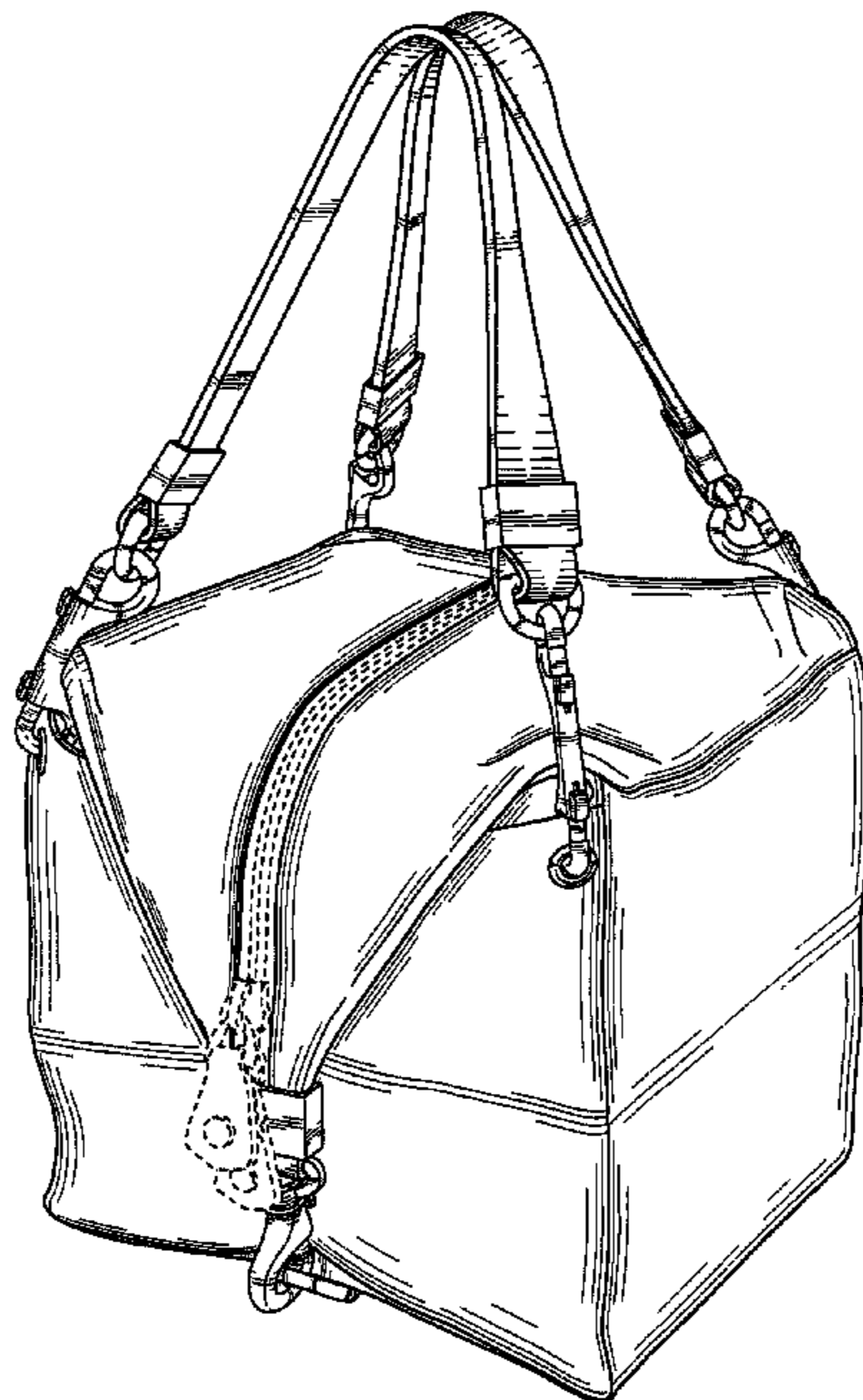

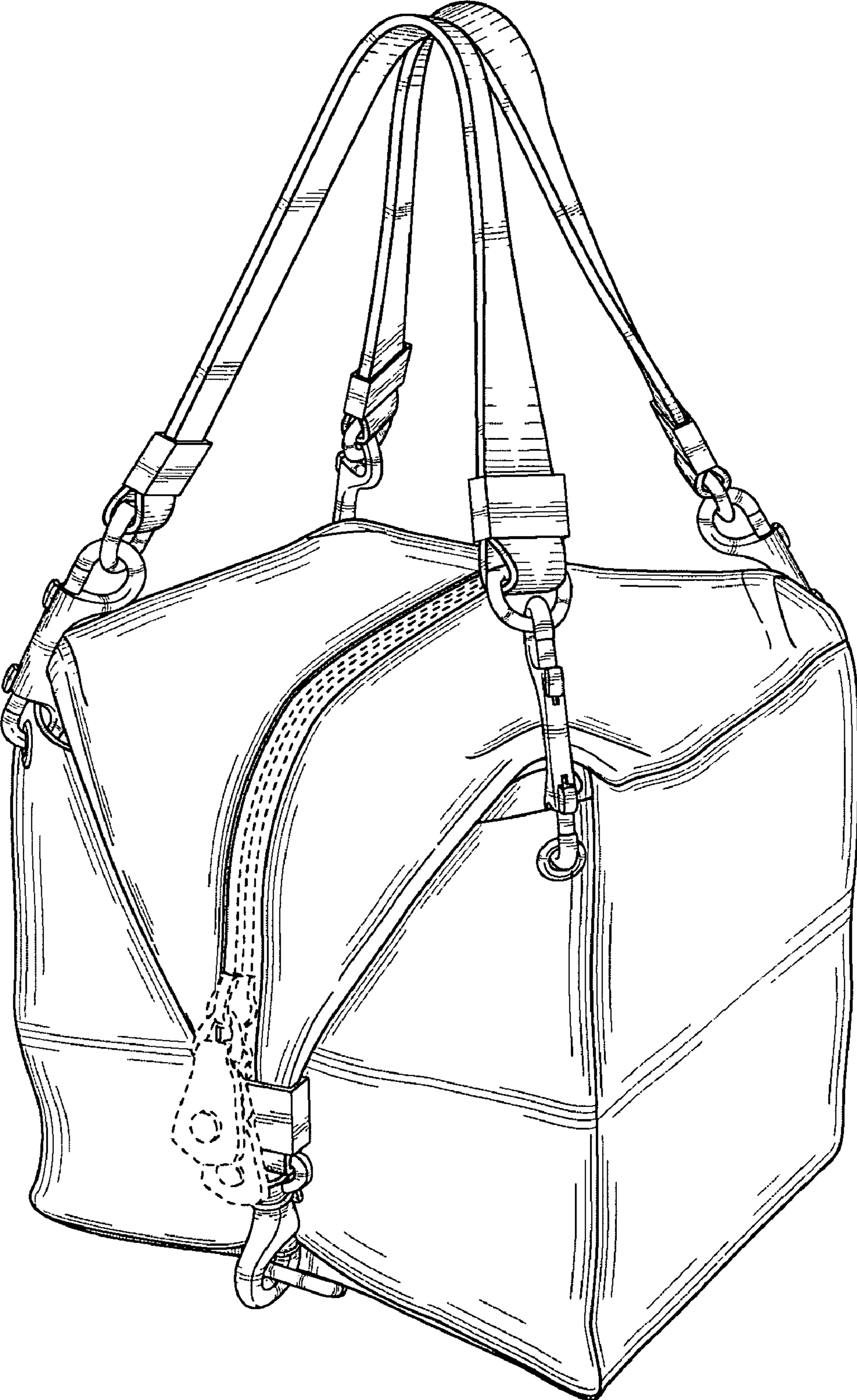

FIG. 1

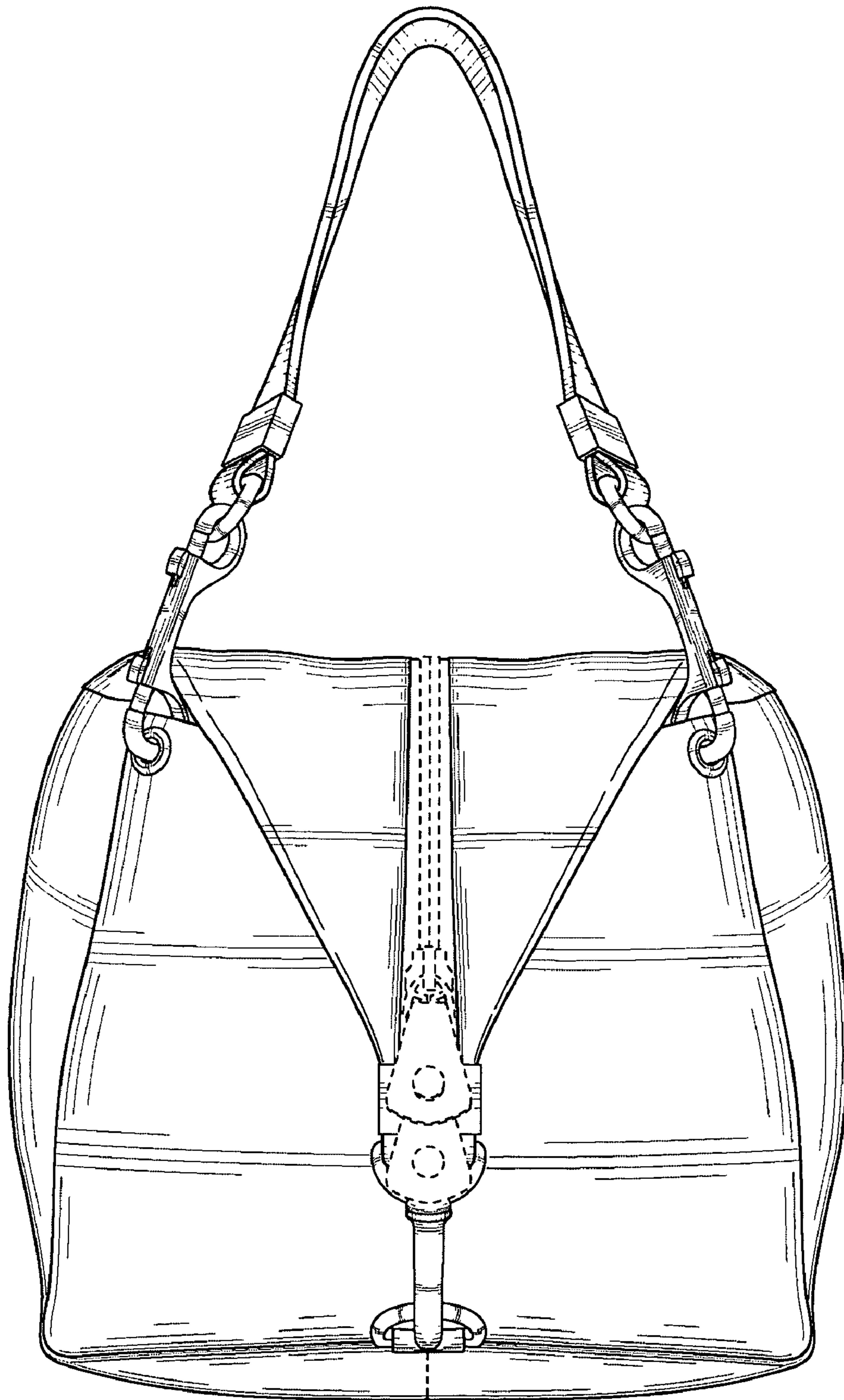

FIG. 2

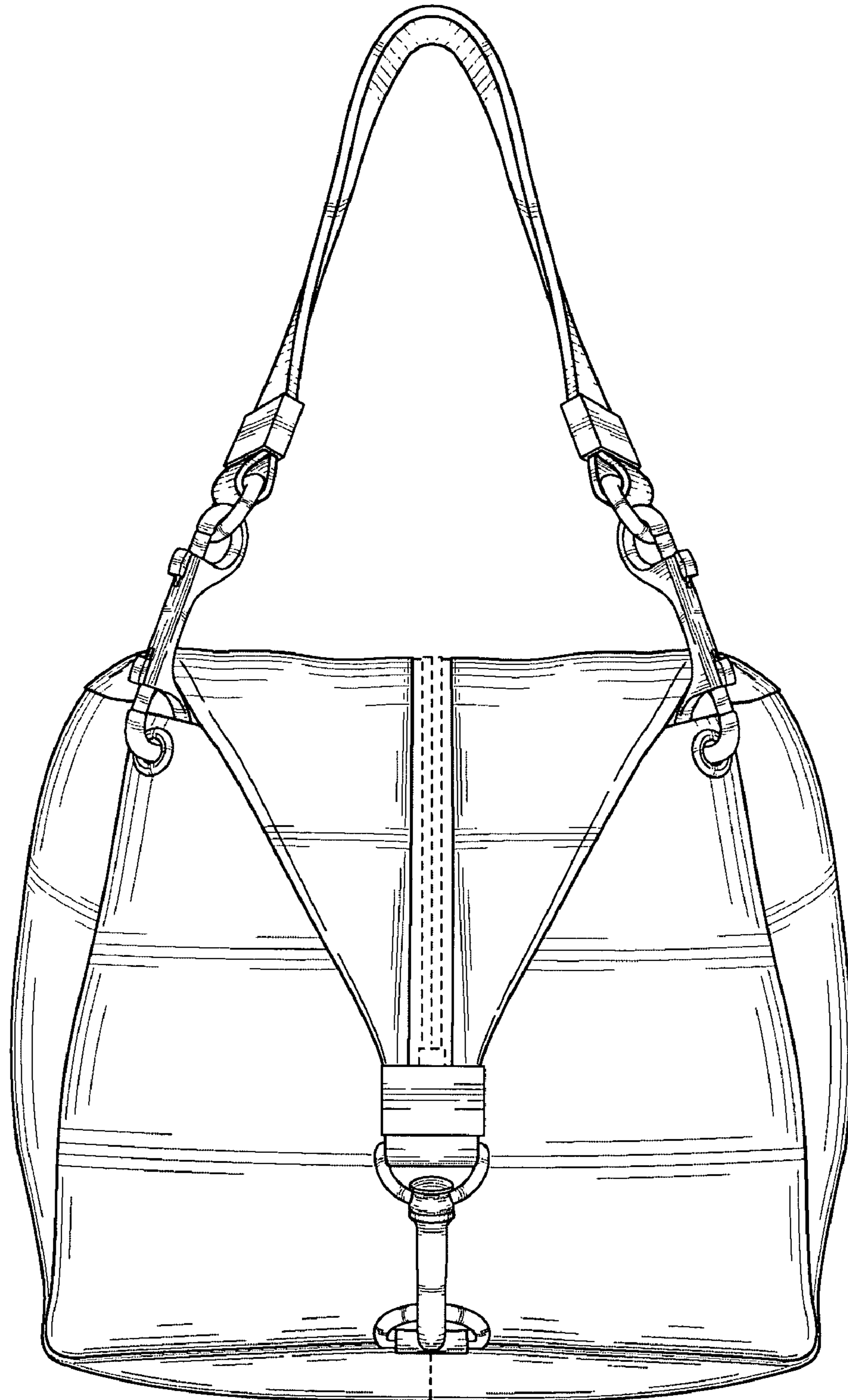

FIG. 3

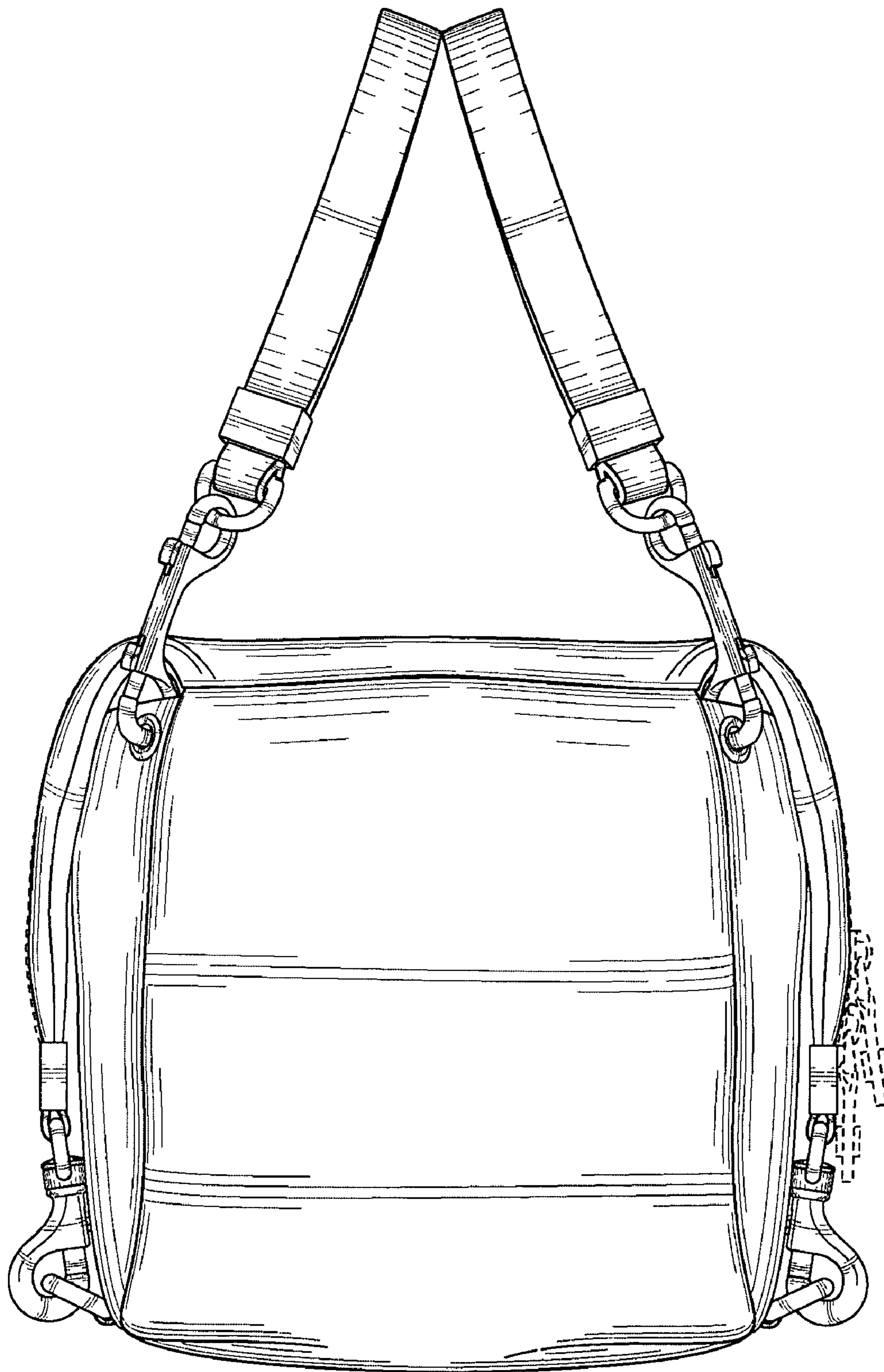

FIG. 4



FIG. 5

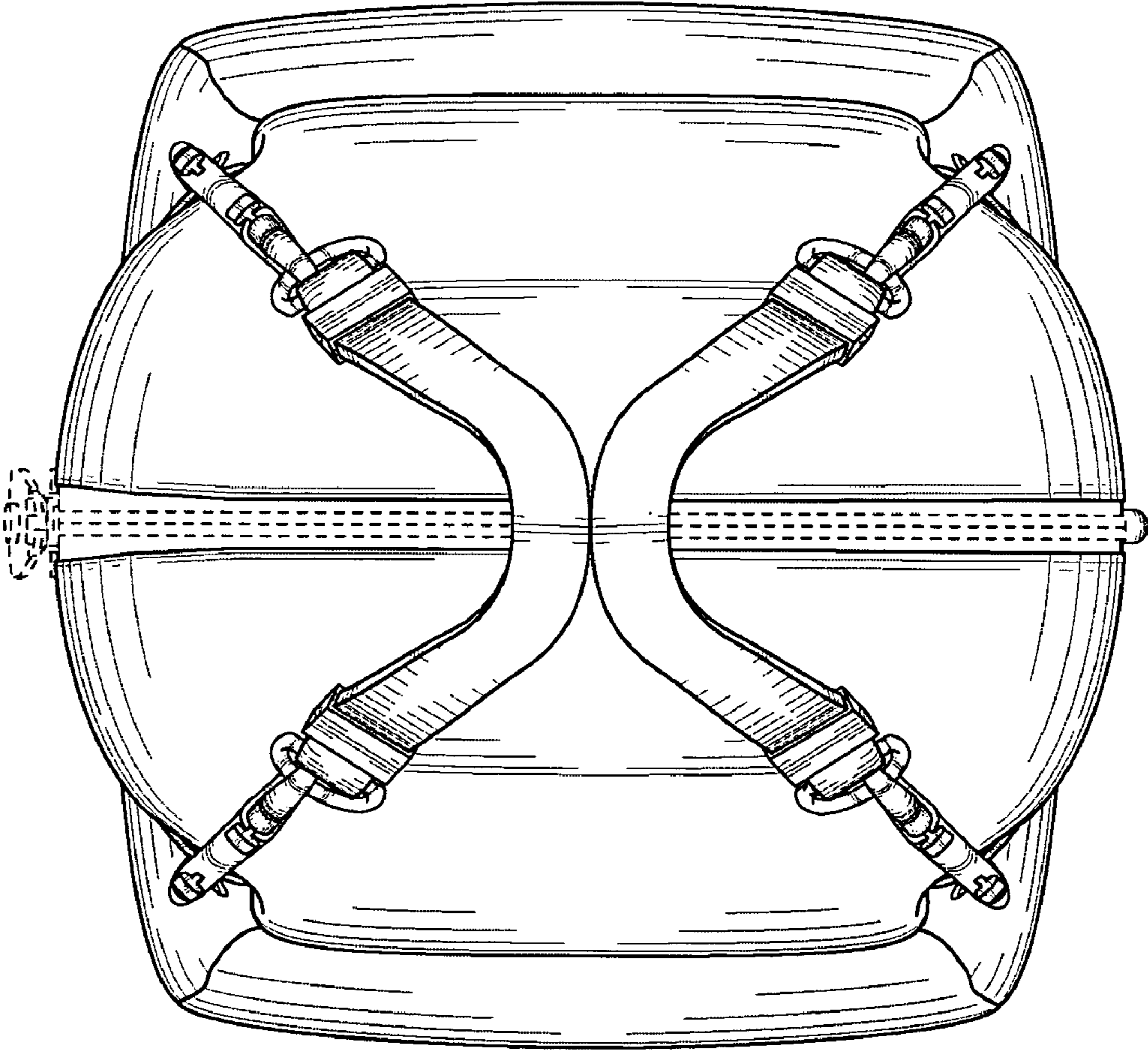

FIG. 6

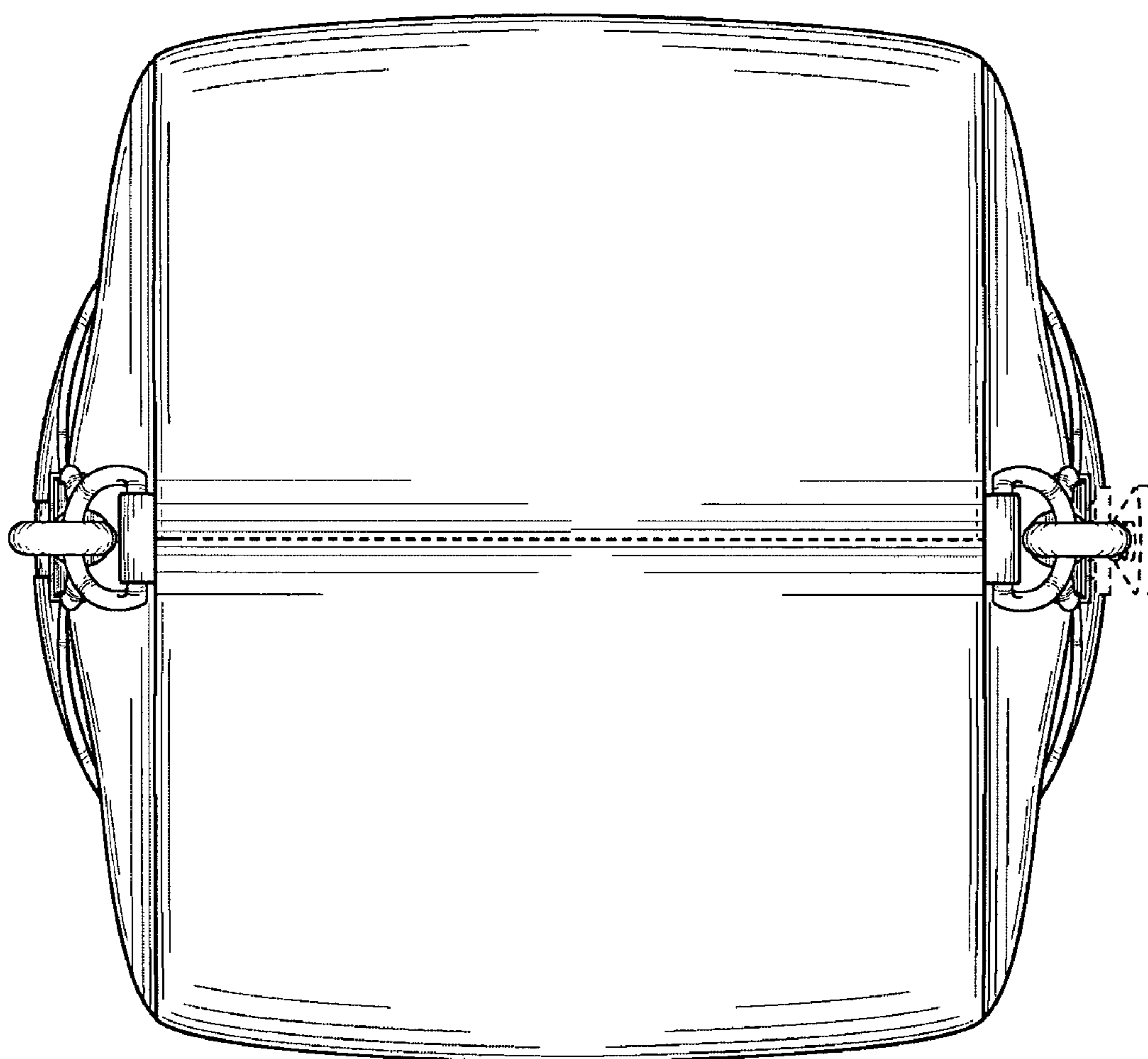

FIG. 7

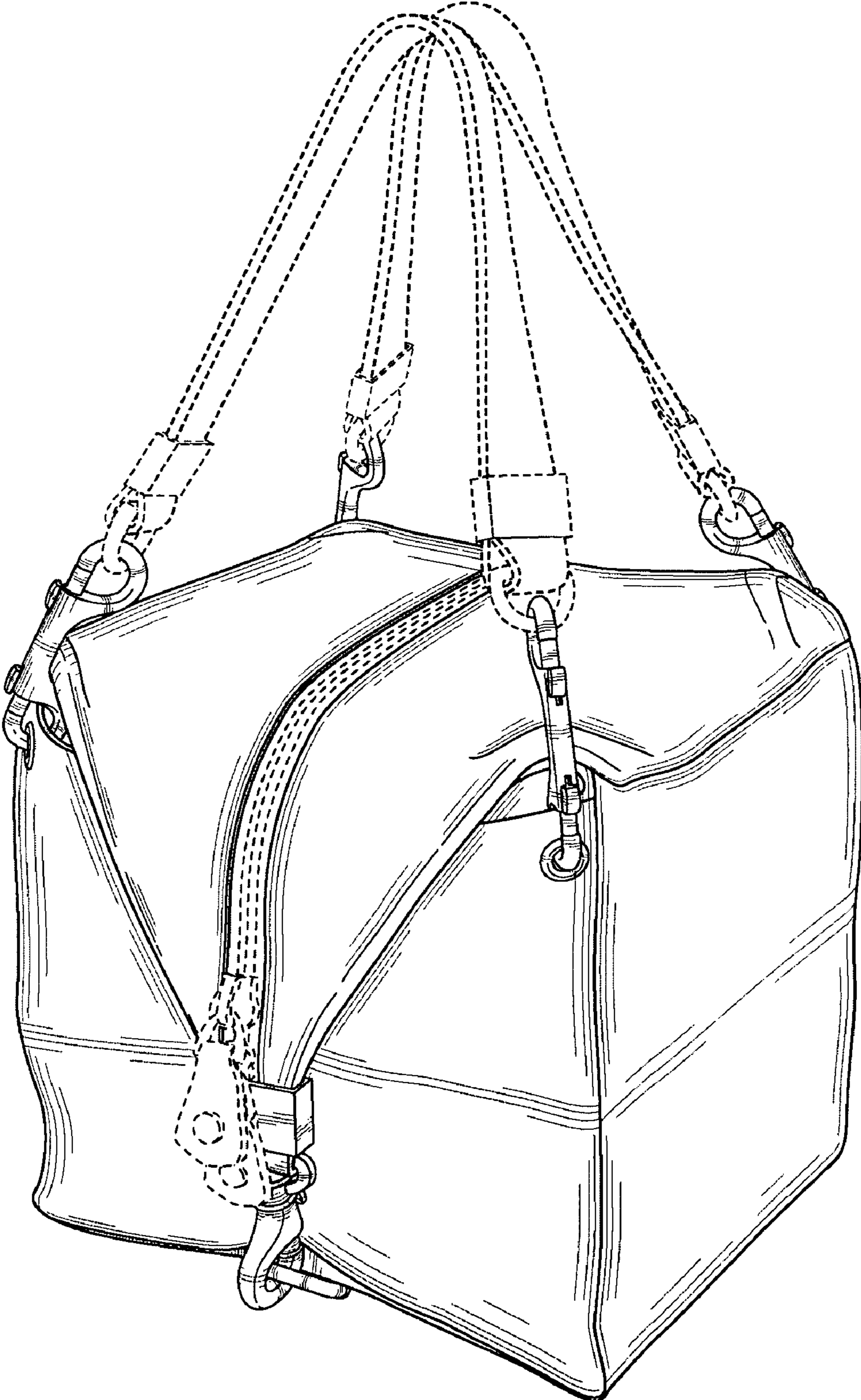

FIG. 8

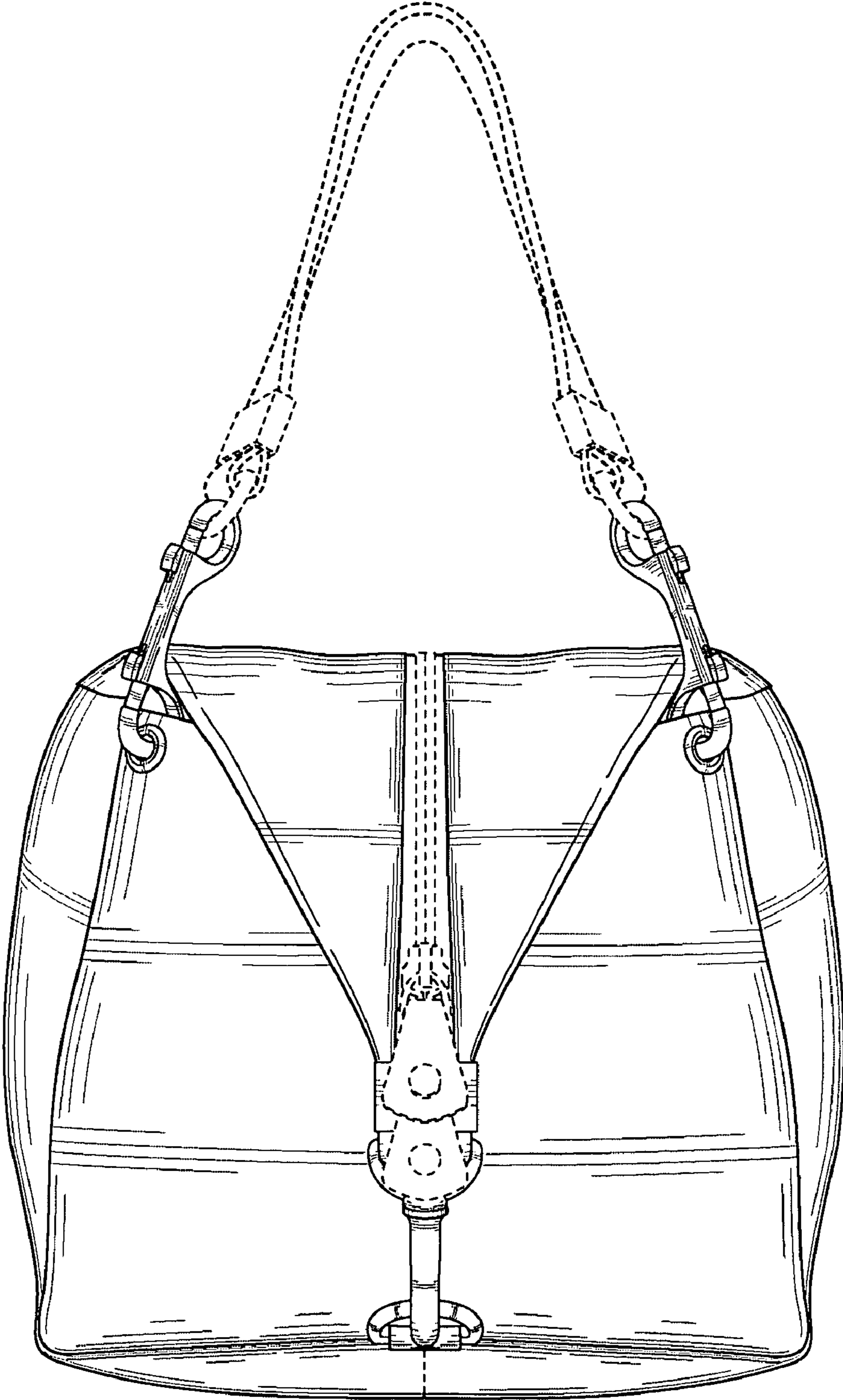

FIG. 9

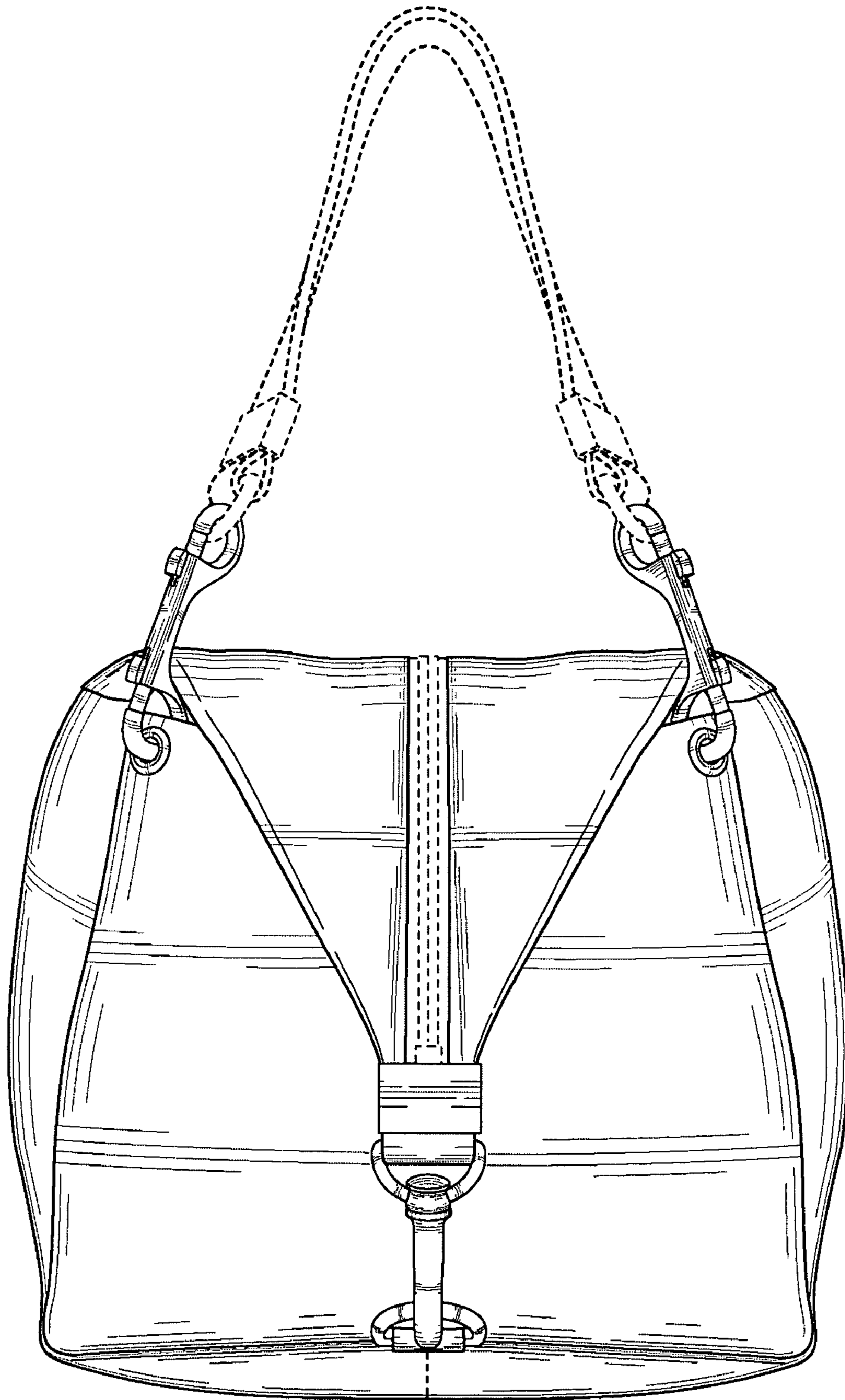

FIG. 10

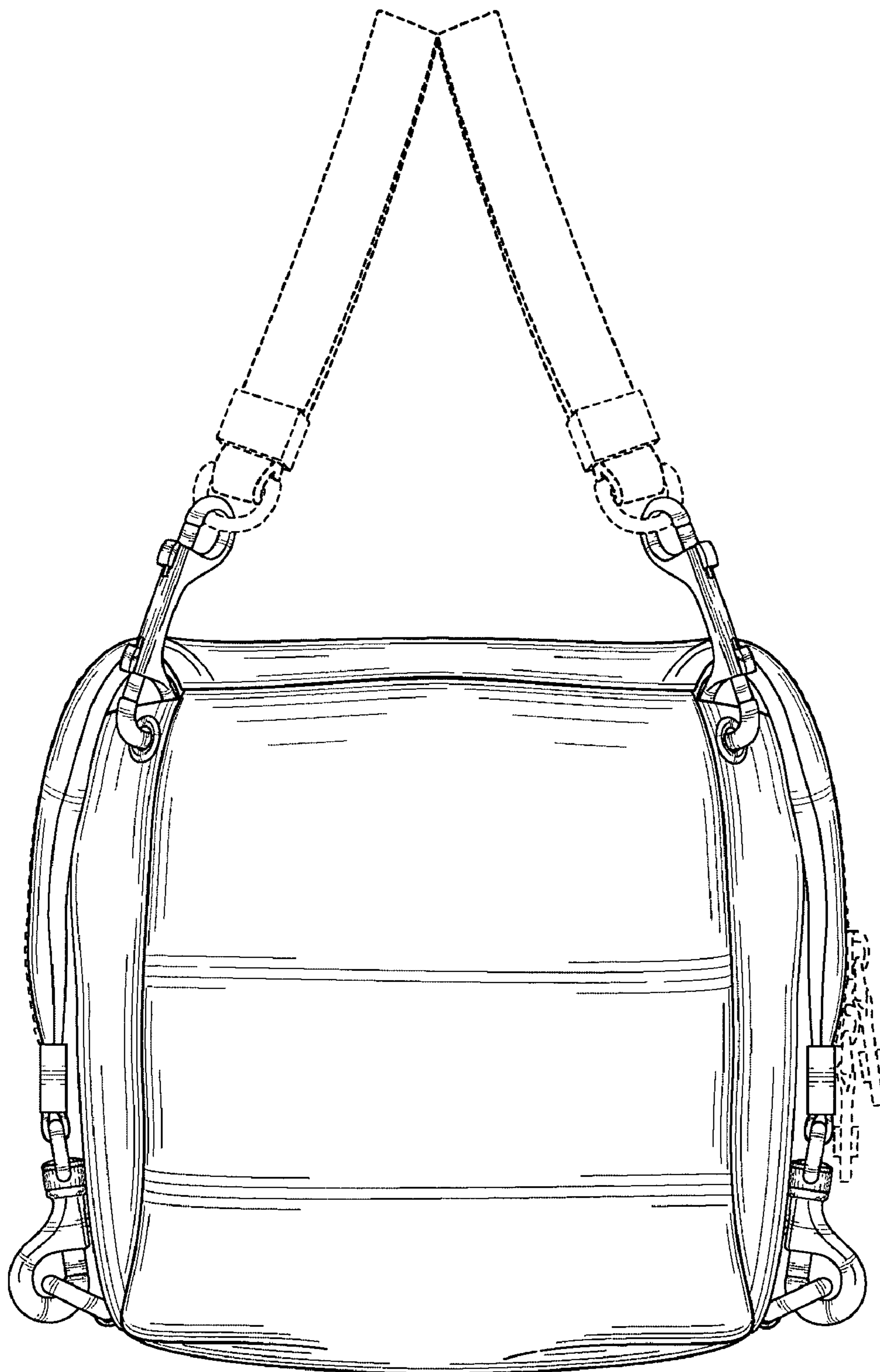

FIG. 11

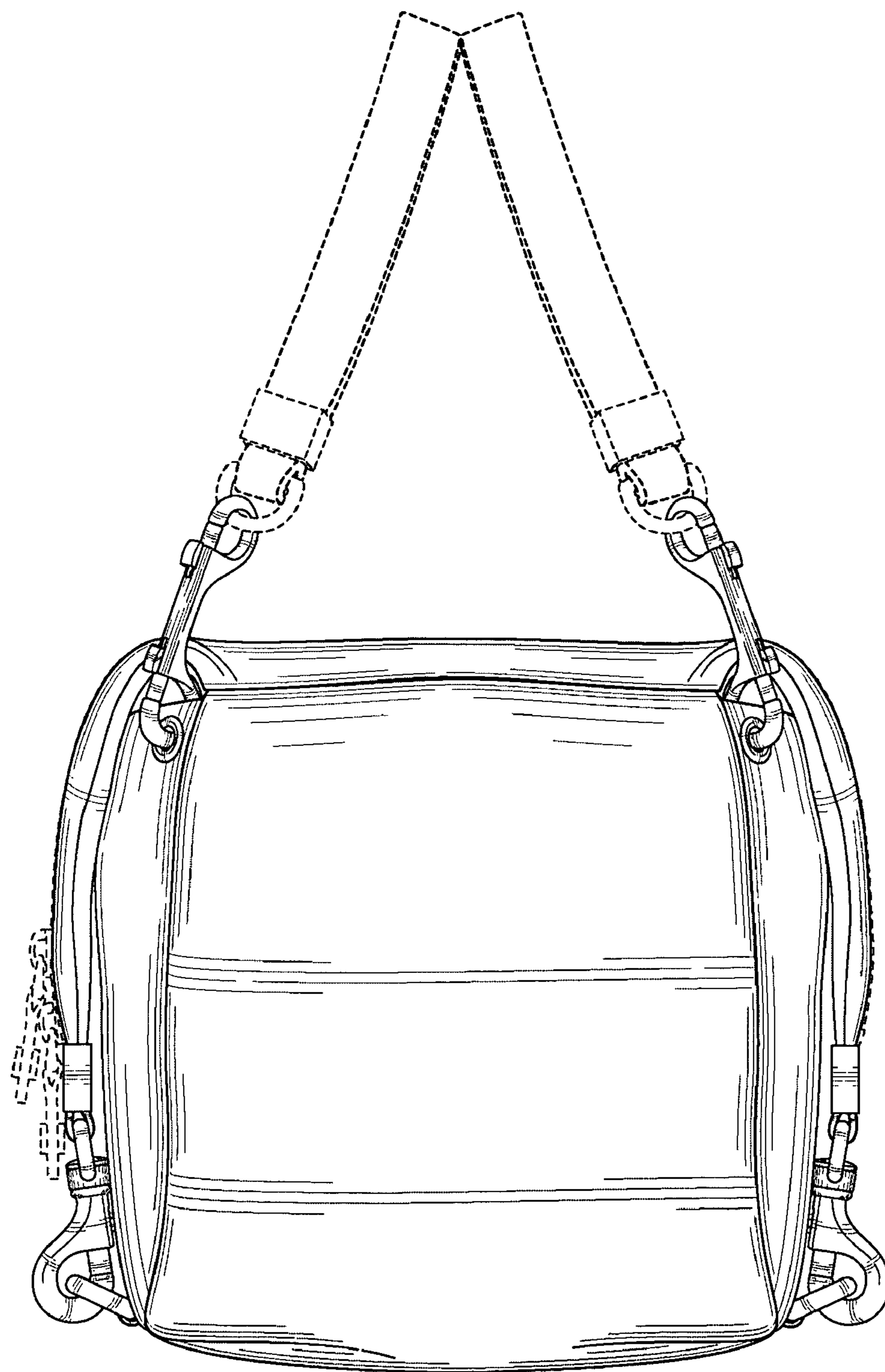

FIG. 12

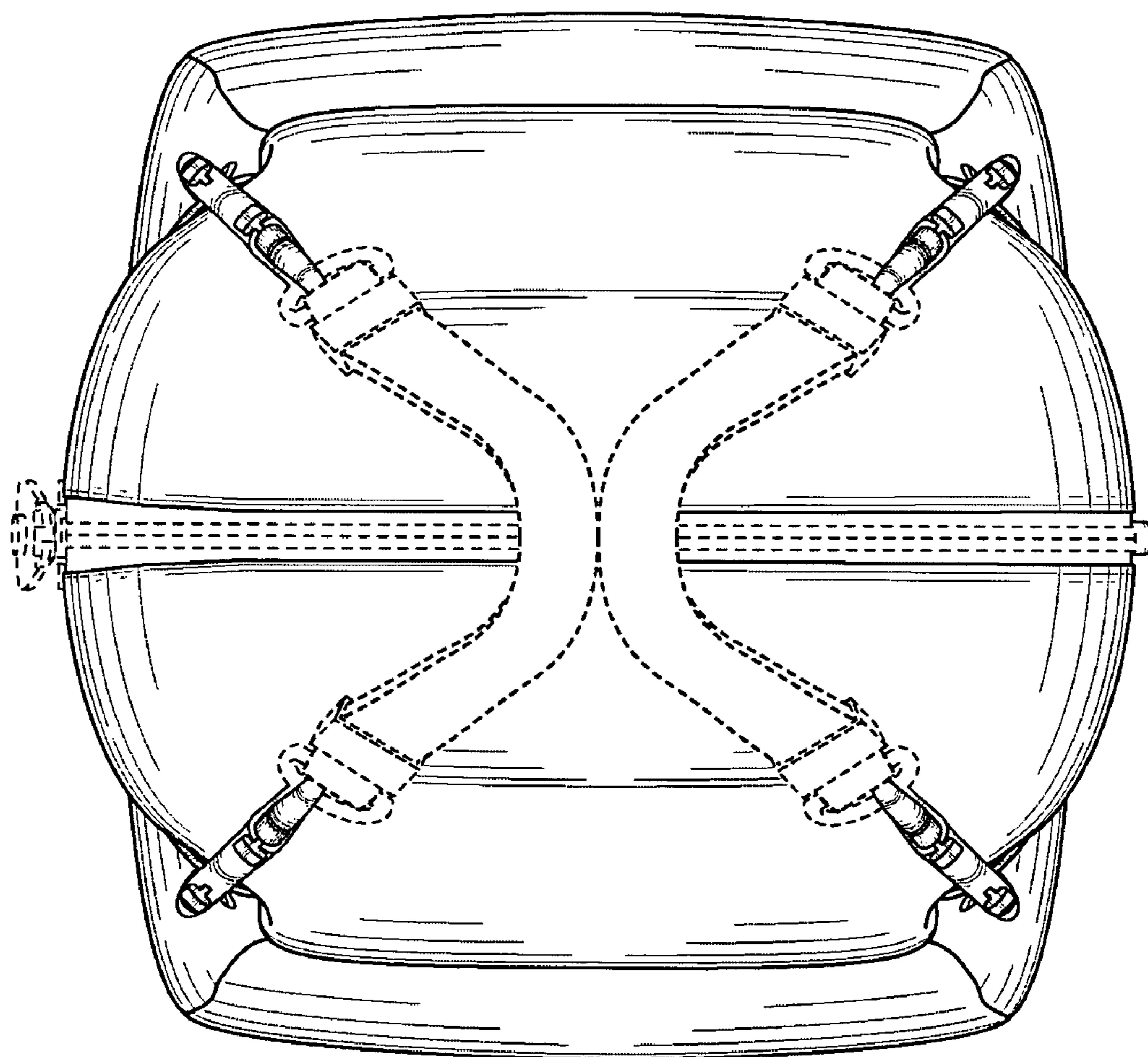

FIG. 13

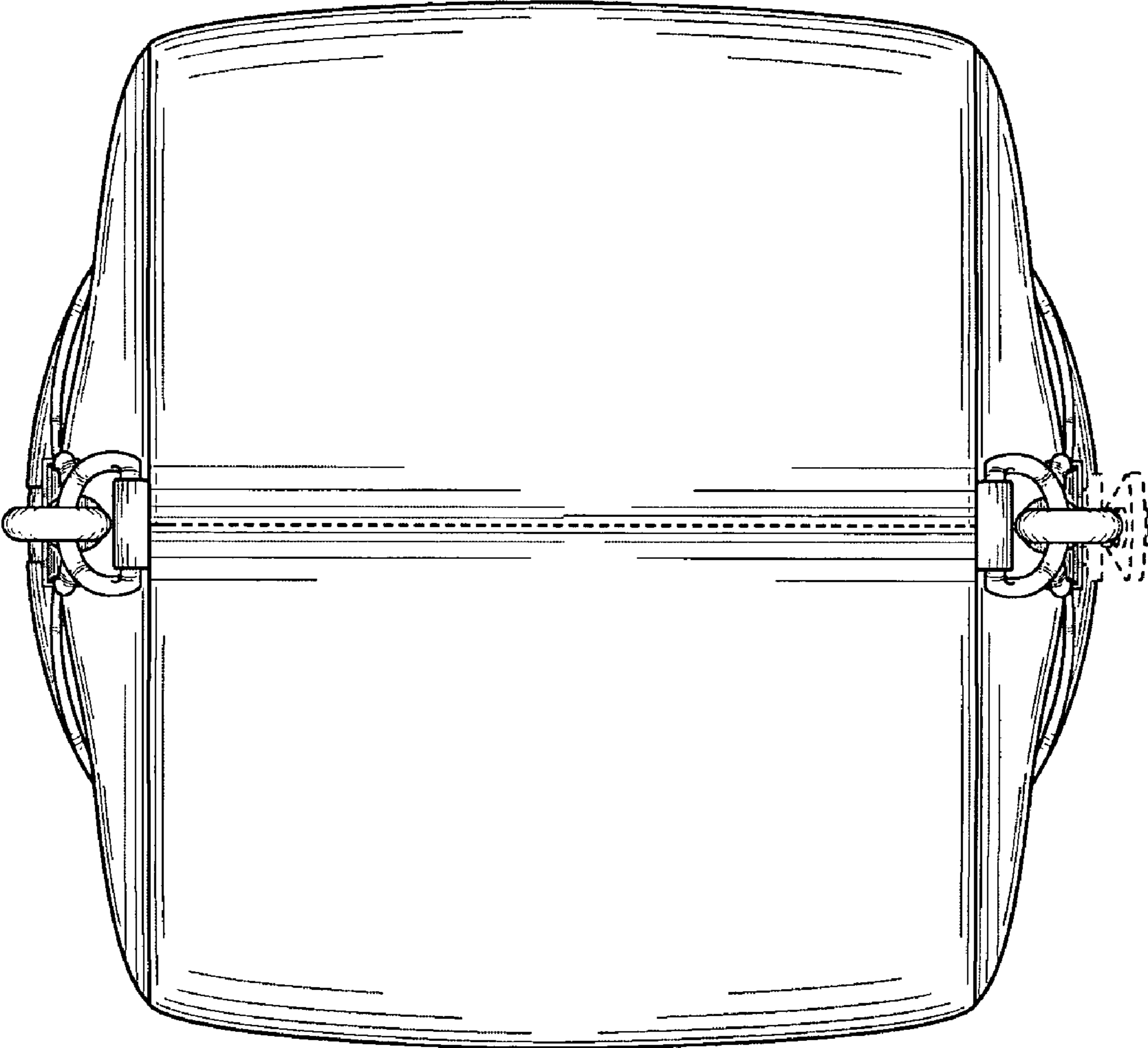

FIG. 14