



US00D600340S

(12) **United States Design Patent**
Parker et al.

(10) **Patent No.:** **US D600,340 S**

(45) **Date of Patent:** **** Sep. 15, 2009**

(54) **FAN BLADE**

(75) Inventors: **Danny S. Parker**, Cocoa Beach, FL (US); **Bart Hibbs**, Altadena, CA (US)

(73) Assignee: **University of Central Florida Research Foundation, Inc.**, Orlando, FL (US)

(**) Term: **14 Years**

(21) Appl. No.: **29/312,827**

(22) Filed: **Nov. 14, 2008**

Related U.S. Application Data

(62) Division of application No. 29/259,708, filed on May 12, 2006, now Pat. No. Des. 594,552.

(51) **LOC (9) Cl.** **23-04**

(52) **U.S. Cl.** **D23/413**

(58) **Field of Classification Search** D23/413, D23/411, 370, 379; 416/223 R, 238; D12/214
See application file for complete search history.

(56) **References Cited**

U.S. PATENT DOCUMENTS

1,233,696 A	7/1917	Pakemen	
1,903,823 A	4/1933	Lougheed	
1,942,688 A	1/1934	Davis	244/12
2,283,956 A	5/1942	Smith	170/159
2,345,047 A	3/1944	Houghton	170/162
2,350,939 A	6/1944	Sprouse	230/134
2,450,440 A	10/1948	Mills	
3,173,490 A	3/1965	Stuart, III	170/159
3,854,845 A	12/1974	Van De Water	416/228
D242,616 S	12/1976	Meyerhoff et al.	D12/214
4,150,919 A	4/1979	Matucheski	416/93 R
4,197,057 A	4/1980	Hayashi	416/242
D261,803 S	11/1981	Bohanon, Jr.	D23/163
4,325,675 A	4/1982	Gallot	416/223
4,411,598 A	10/1983	Okada	416/223

(Continued)

OTHER PUBLICATIONS

HVAC, Exhaust Fans, Attic Ventilators, [online] Grainger.com, Grainger, for the ones who get it done, 3 pages, [retrieved on Apr. 21, 2006] Retrieved from: <http://www.grainger.com/Grainger/wwg/productIndex.shtml?operator=searchProductBySu...>
U.S. Appl. No. 29/152,381, filed Dec. 1, 1959, Szydlowski.
HVAC, Exhaust Fans, Attic Ventilators, [online] Grainger.com, Grainger, for the ones who get it done, 3 pgs, [retrieved on Apr. 21, 2006] Retrieved From: <http://www.grainger.com/Grainger/wwg/productIndex.shtml?operator=searchProductBySu...>

Primary Examiner—Lisa P Lichtenstein

(74) *Attorney, Agent, or Firm*—Brian S. Steinberger; Law Offices of Brian S. Steinberger, P.A.

(57) **CLAIM**

The ornamental design for a fan blade, as shown.

DESCRIPTION

FIG. 1 is a perspective bottom view of a fan blade in use.

FIG. 2 is a perspective top view of the fan of FIG. 1.

FIG. 3 is a bottom view of the fan of FIG. 1.

FIG. 4 is a top view of the fan of FIG. 1.

FIG. 5 is a front side view of the fan of FIG. 1.

FIG. 6 is a rear side view of the fan of FIG. 1.

FIG. 7 is a left side view of the fan of FIG. 1.

FIG. 8 is a right side view of the fan of FIG. 1.

FIG. 9 is perspective bottom view of another fan having three twisted blades with a hub.

FIG. 10 is a perspective top view of the fan of FIG. 9.

FIG. 11 is a bottom view of the fan of FIG. 9.

FIG. 12 is a top view of the fan of FIG. 9.

FIG. 13 is a front side view of the fan of FIG. 9.

FIG. 14 is a rear side view of the fan of FIG. 9.

FIG. 15 is a left side view of the fan of FIG. 9; and,

FIG. 16 is a right side view of the fan of FIG. 9.

The broken line showing of the hub is included for the purpose of illustrating environmental structure and forms no part of the claimed design.

1 Claim, 8 Drawing Sheets

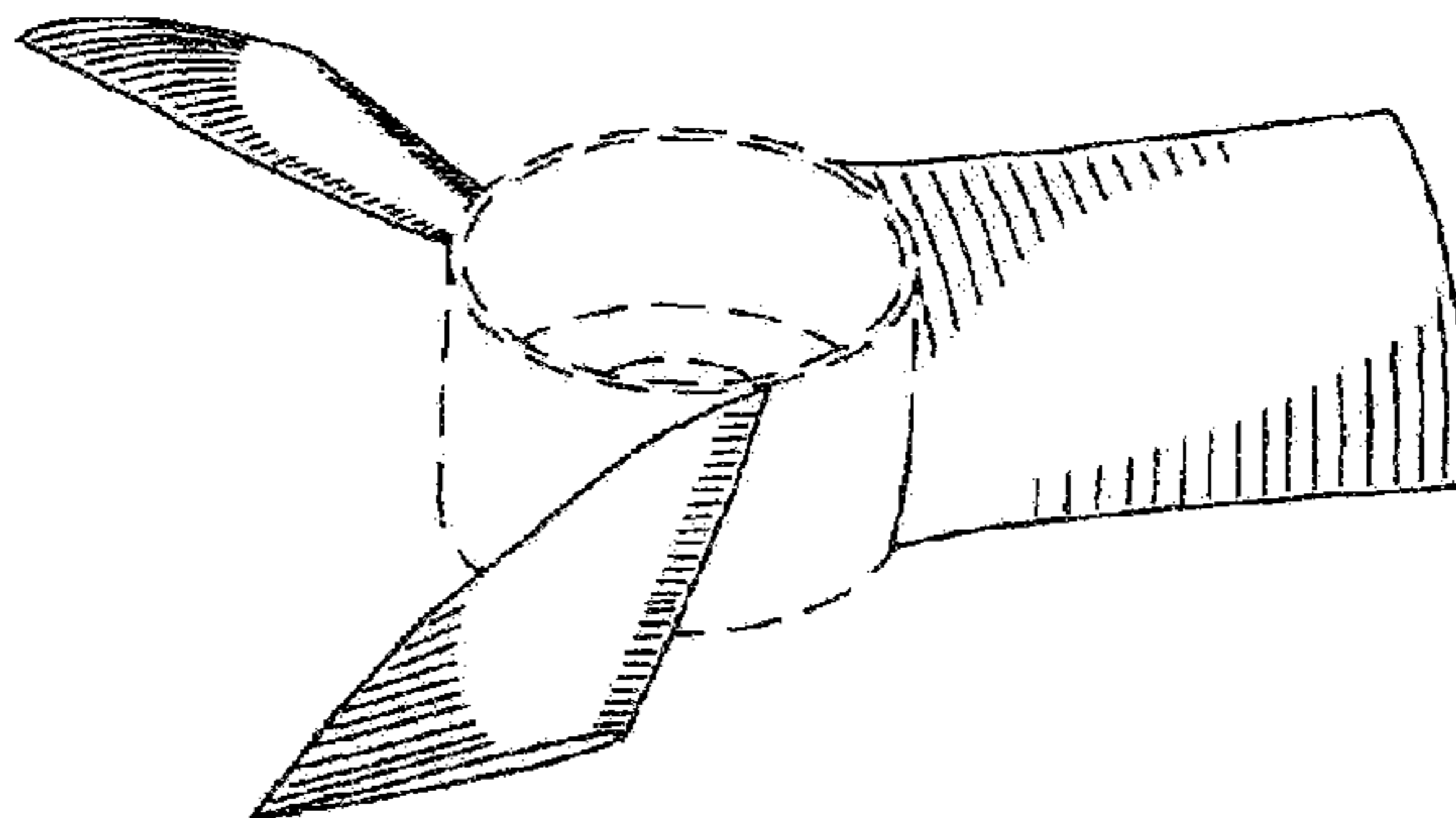

US D600,340 S

Page 2

U.S. PATENT DOCUMENTS

4,416,434	A	11/1983	Thibert et al.	244/35	6,306,030	B1	10/2001	Wilson	454/16
4,501,194	A	2/1985	Brown	98/42.07	6,659,721	B1	12/2003	Parker et al.	416/5
4,730,985	A	3/1988	Rothman et al.	416/228	6,695,692	B1	2/2004	York	454/199
4,844,698	A	7/1989	Gornstein et al.	416/223	6,733,241	B2	5/2004	Bird	416/238
5,078,047	A	1/1992	Wimberly	454/368	6,884,034	B1	4/2005	Parker et al.	416/1
5,114,313	A	5/1992	Vorus	416/93	D509,584	S	9/2005	Li et al.	
5,131,888	A	7/1992	Adkins, II	454/343	D510,998	S	10/2005	Parker et al.	D23/411
5,253,979	A	10/1993	Fradenburgh et al.	416/223	7,014,423	B2	3/2006	Parker et al.	415/220
D368,772	S	4/1996	Liao		D539,413	S	3/2007	Parker et al.	
5,588,909	A	12/1996	Ferng	454/141	D565,165	S	3/2008	Calkins	
6,039,541	A	3/2000	Parker et al.	416/223	D566,829	S *	4/2008	Parker et al.	D23/411

* cited by examiner

FIG. 1

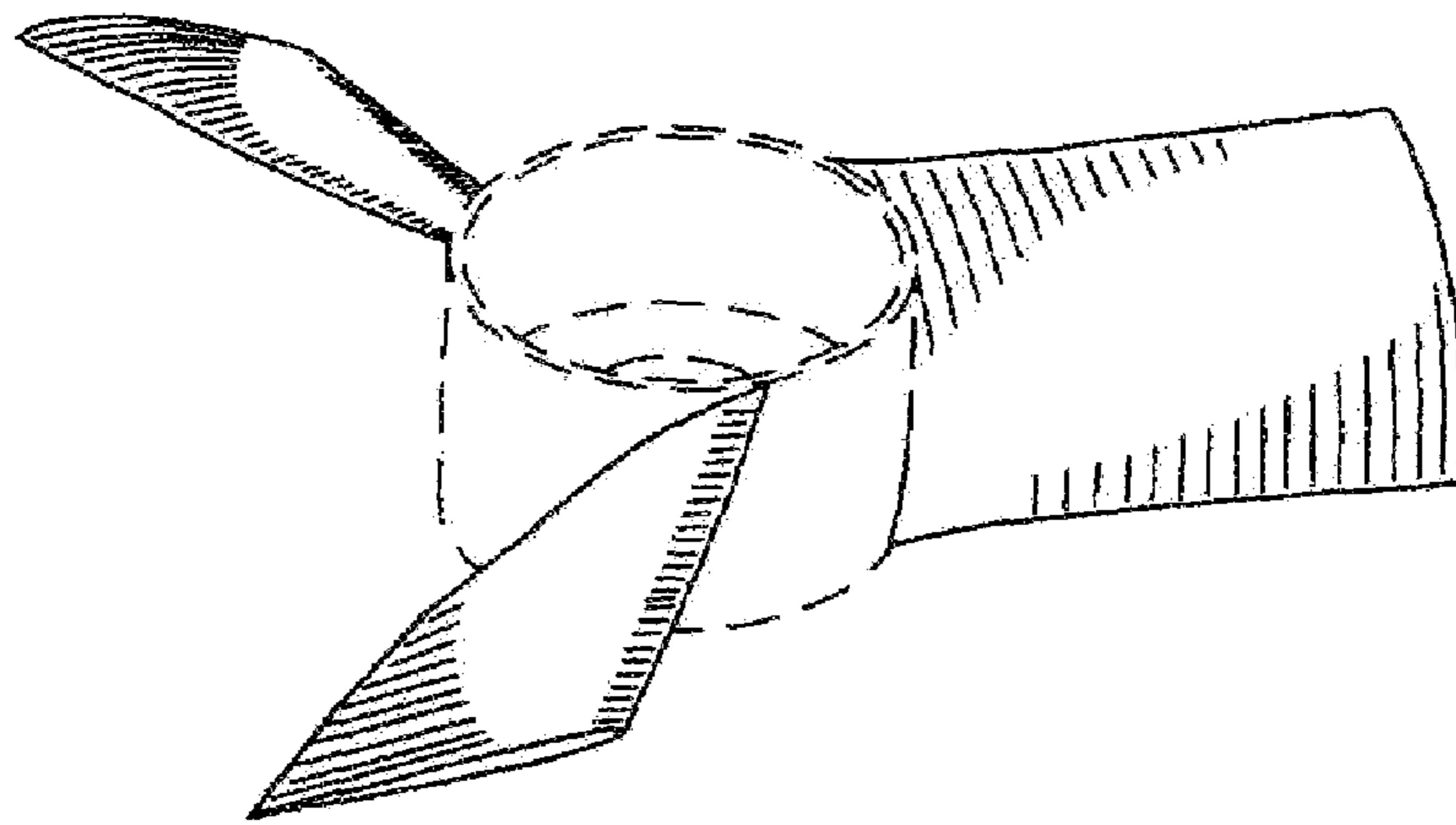
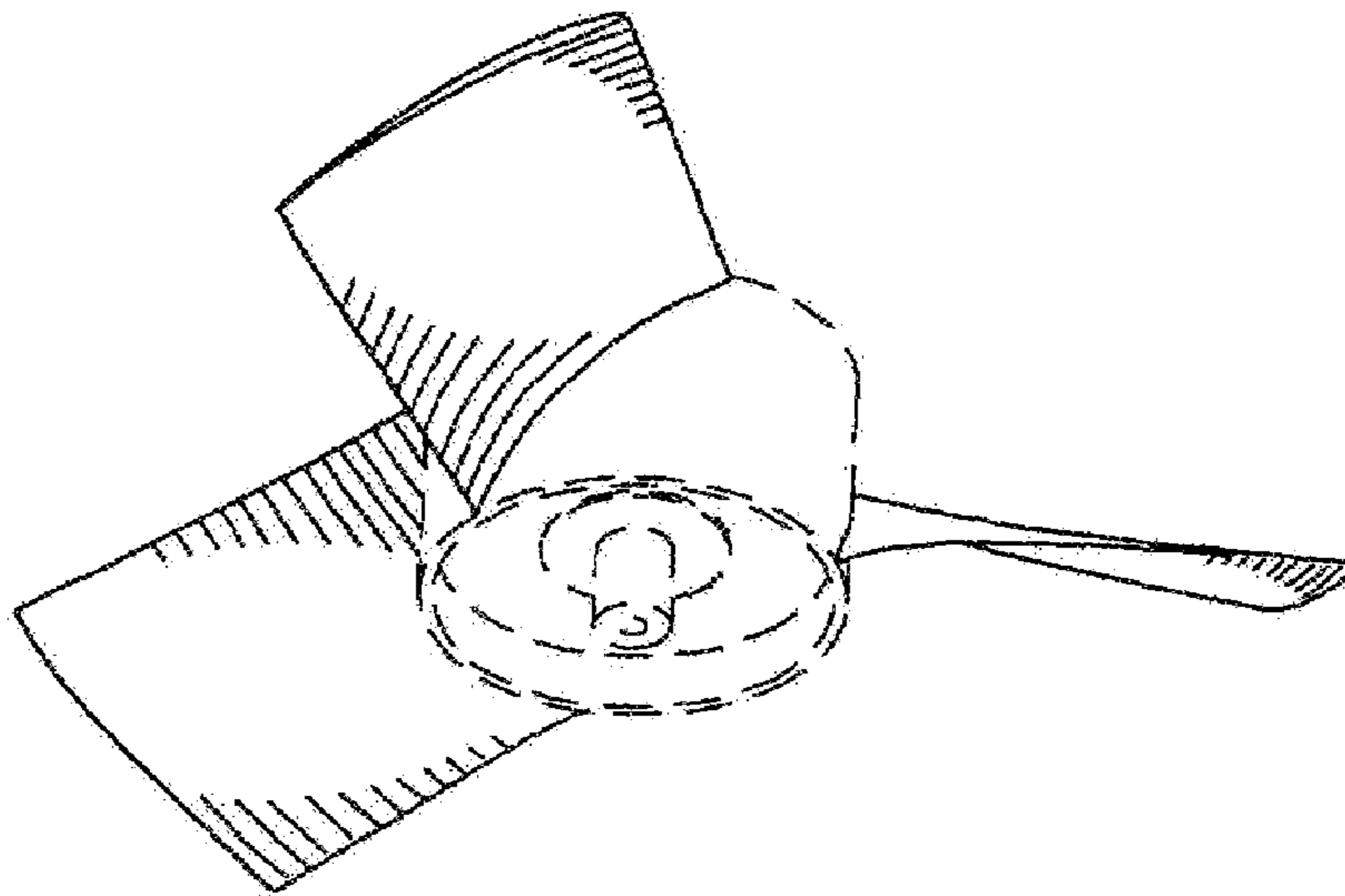

FIG. 2



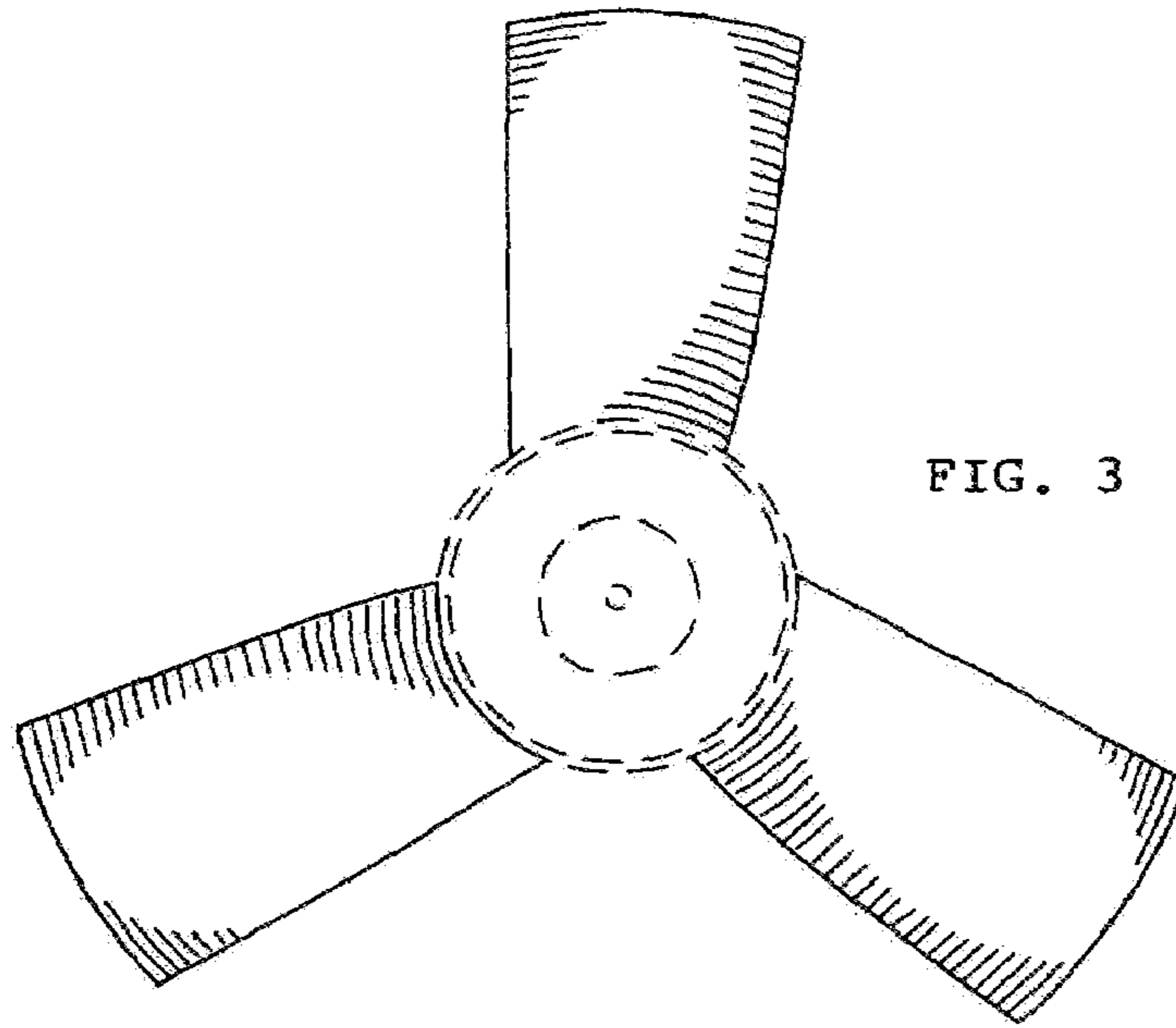

FIG. 3

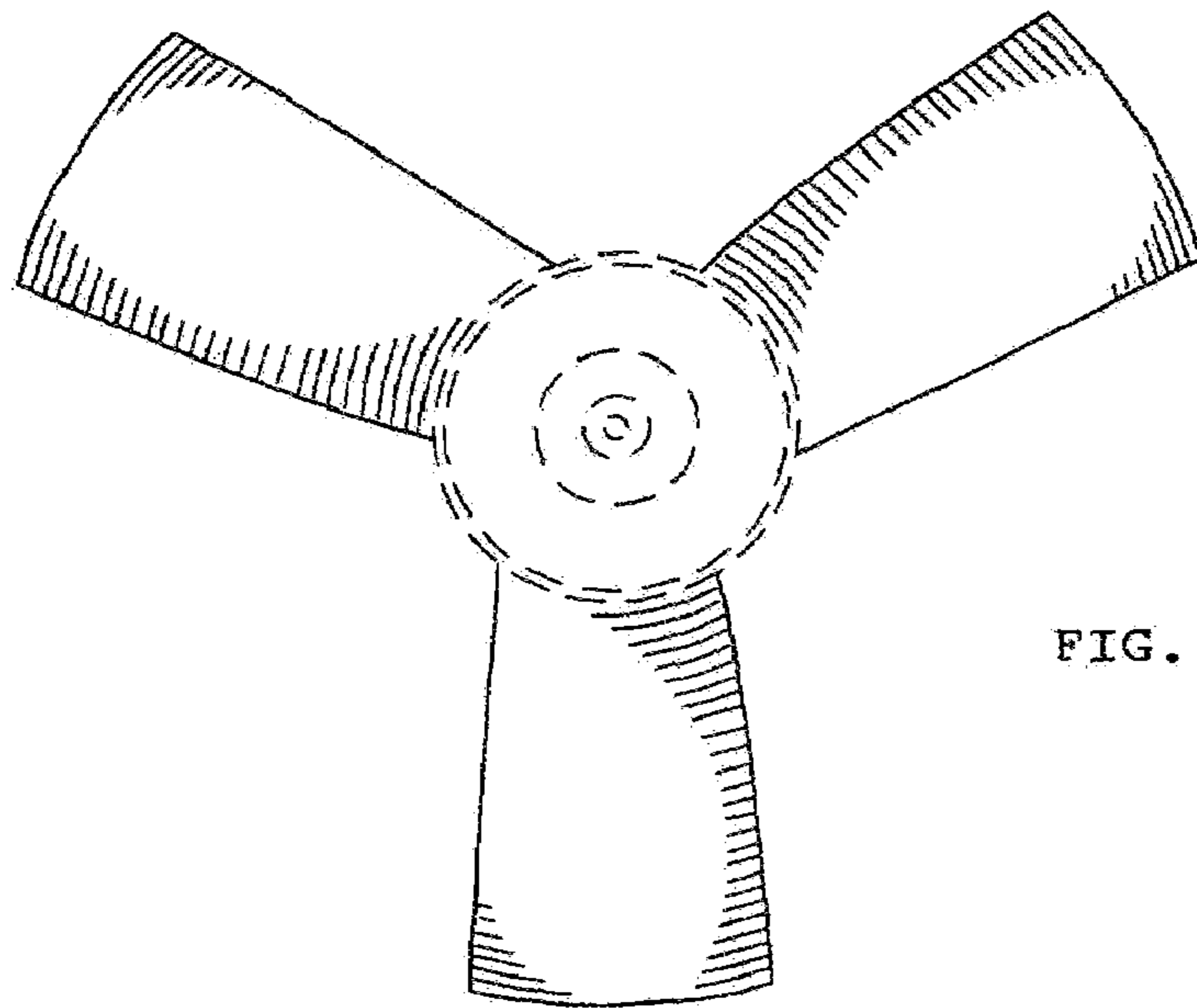

FIG. 4

FIG. 5

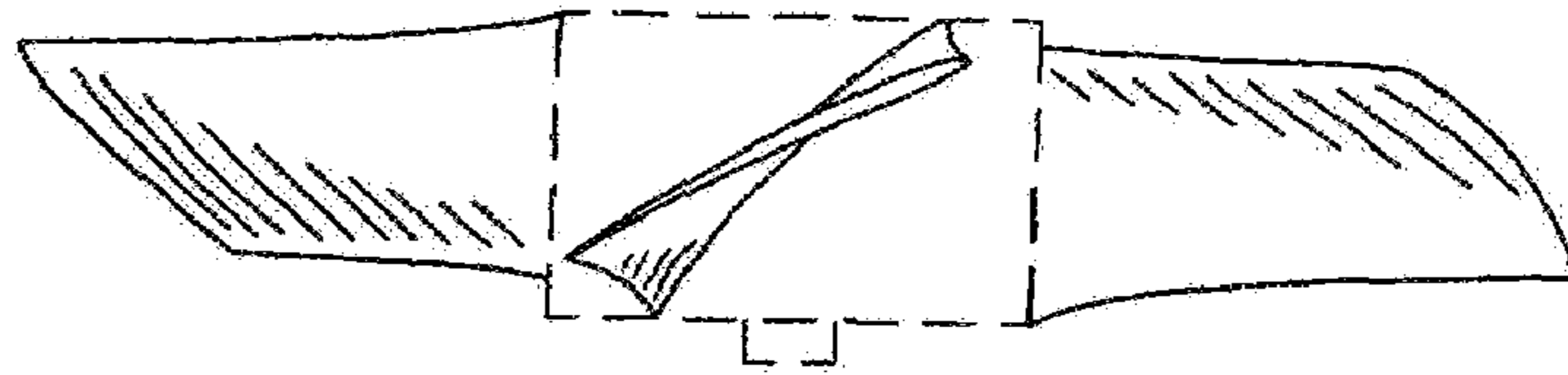

FIG. 6

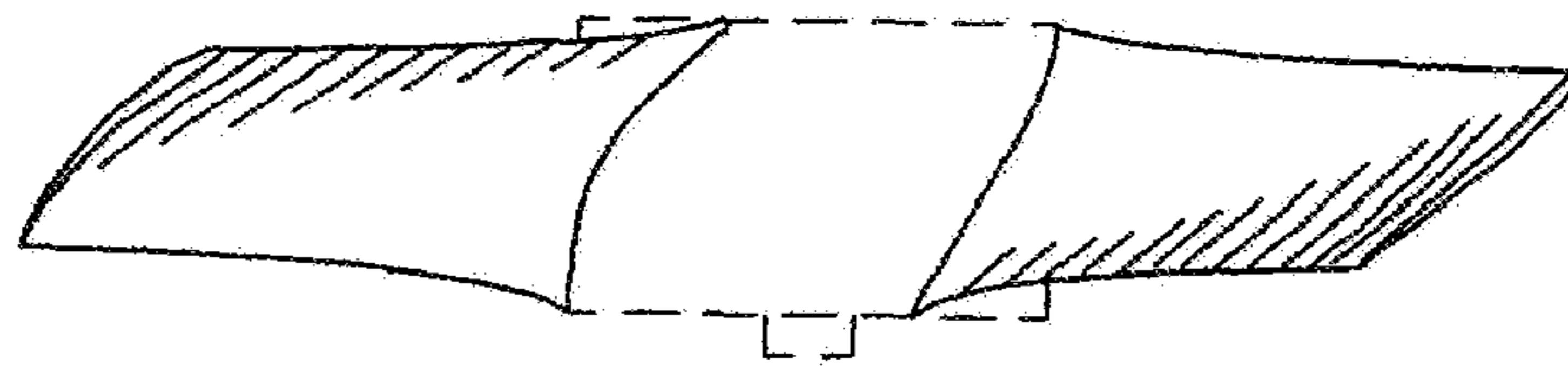

FIG. 7

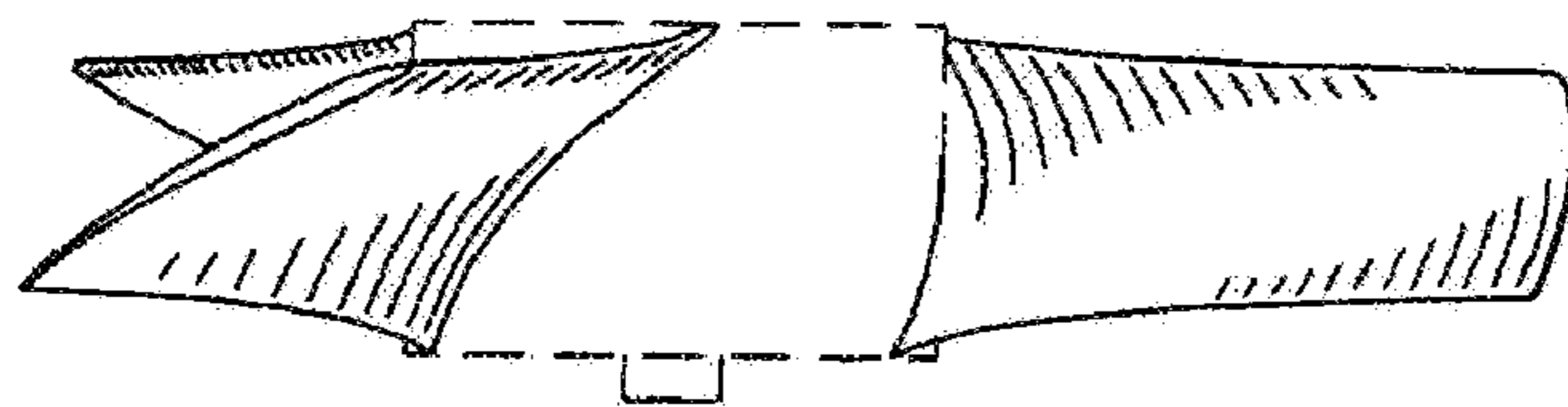

FIG. 8

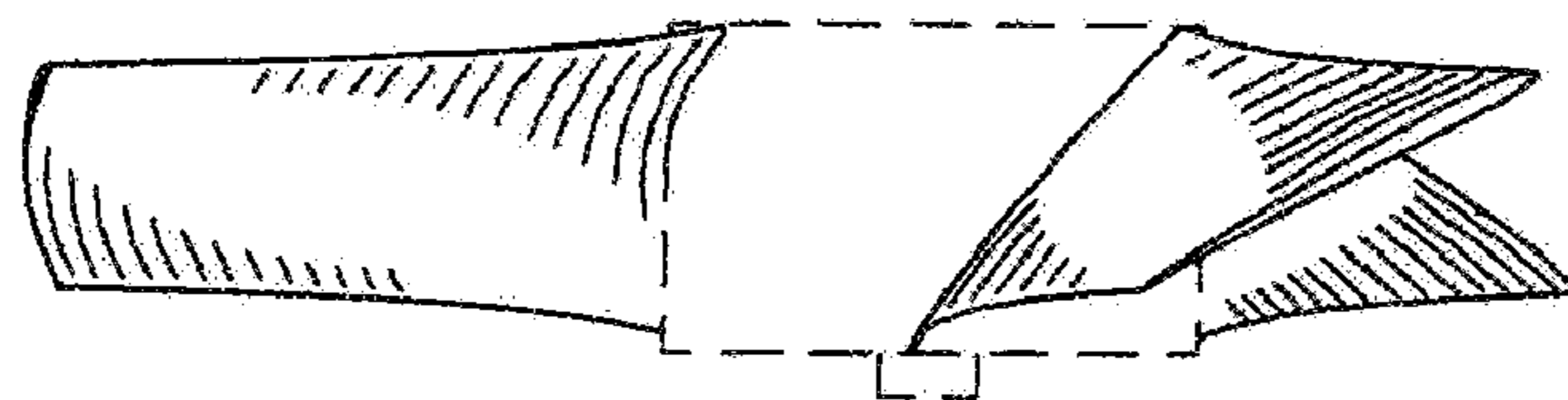

FIG. 9

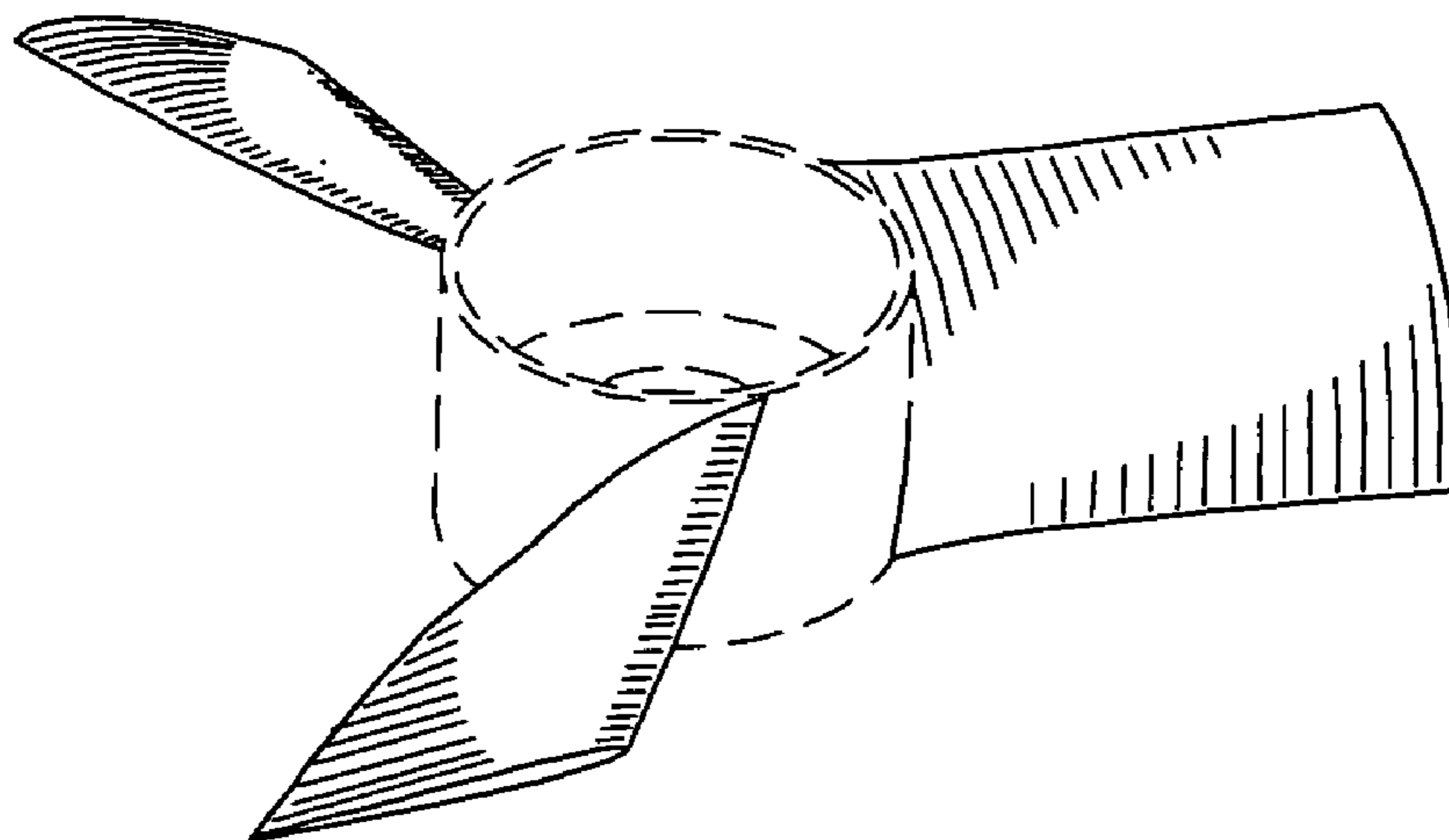
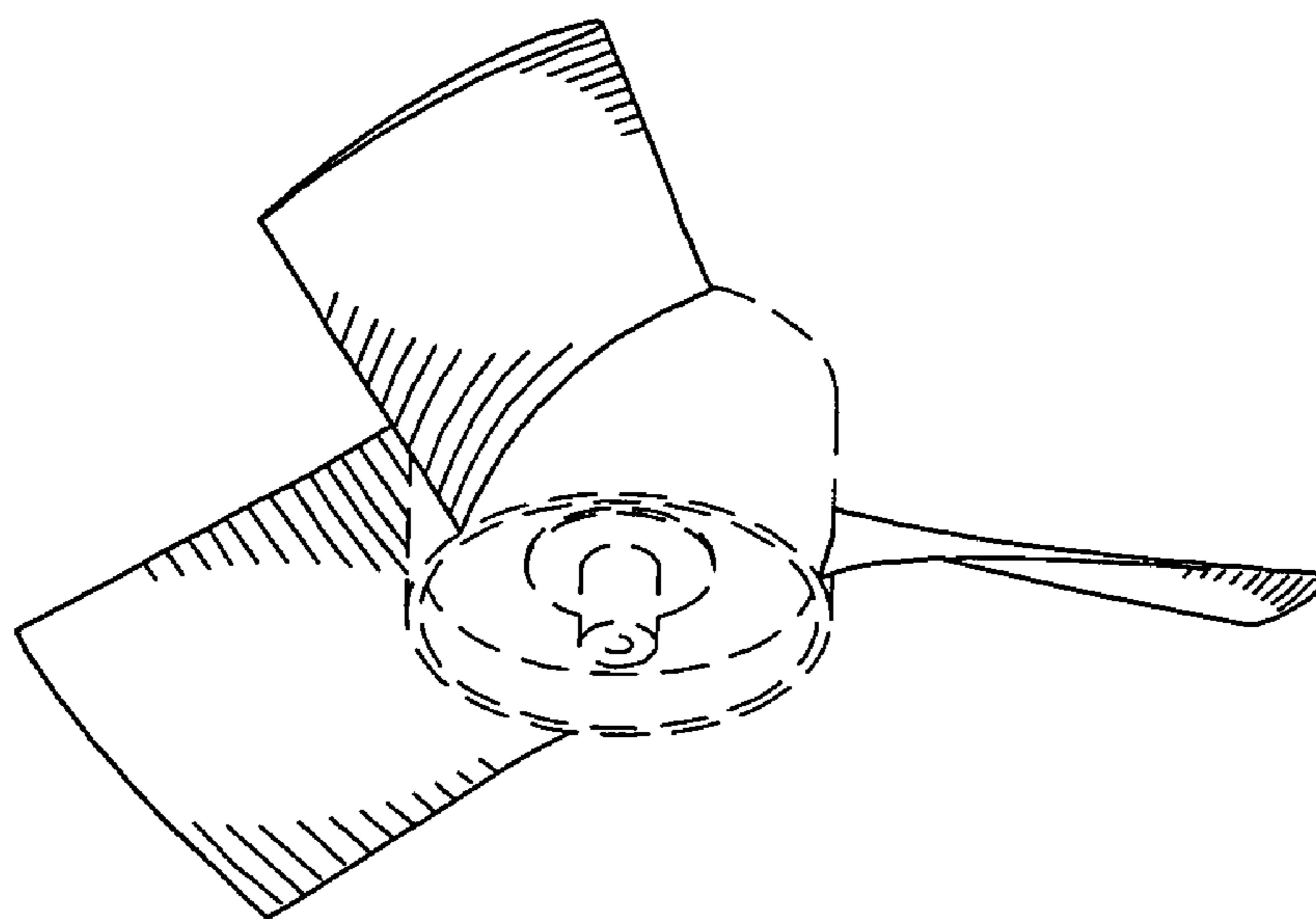

FIG. 10



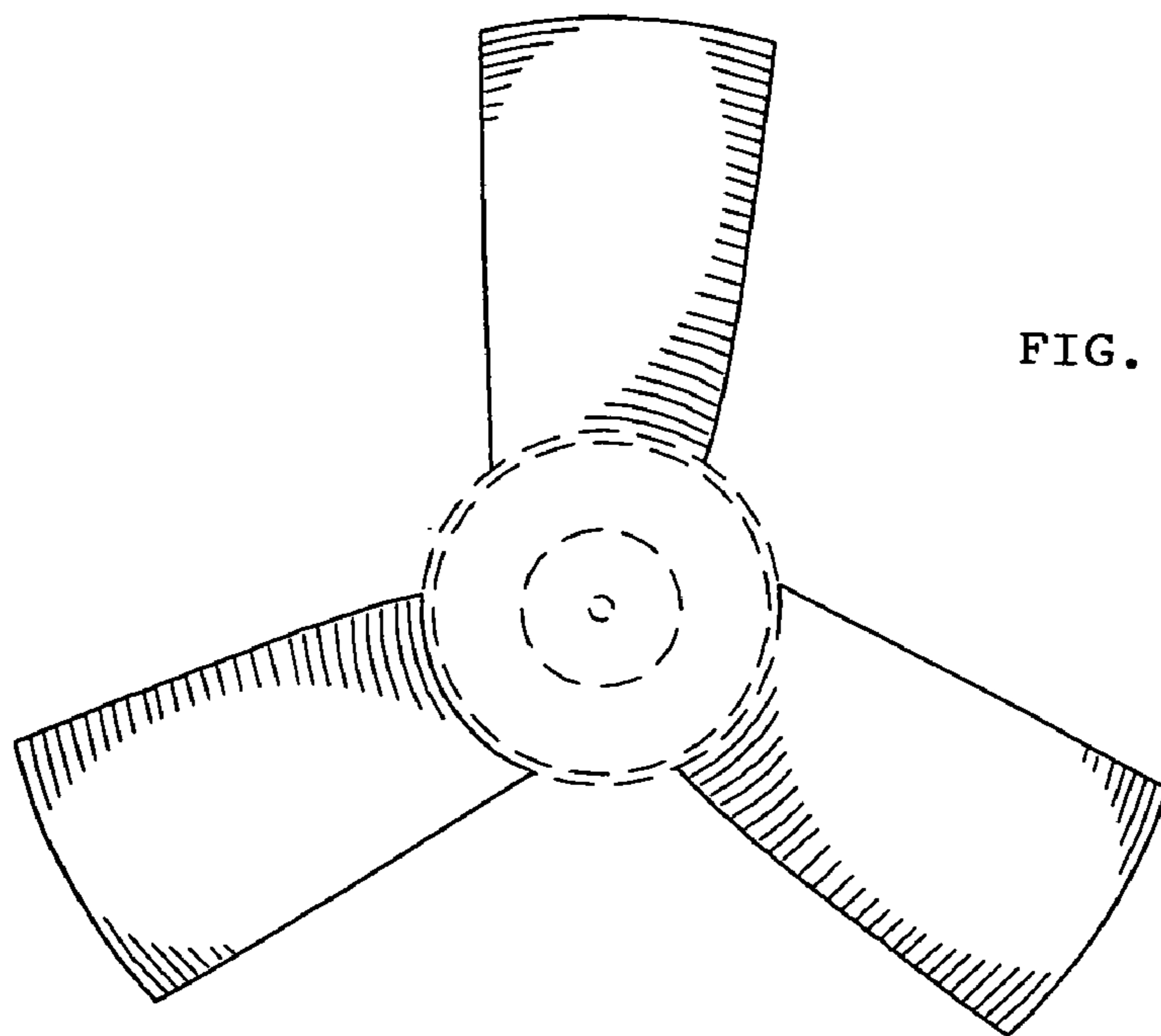

FIG. 11

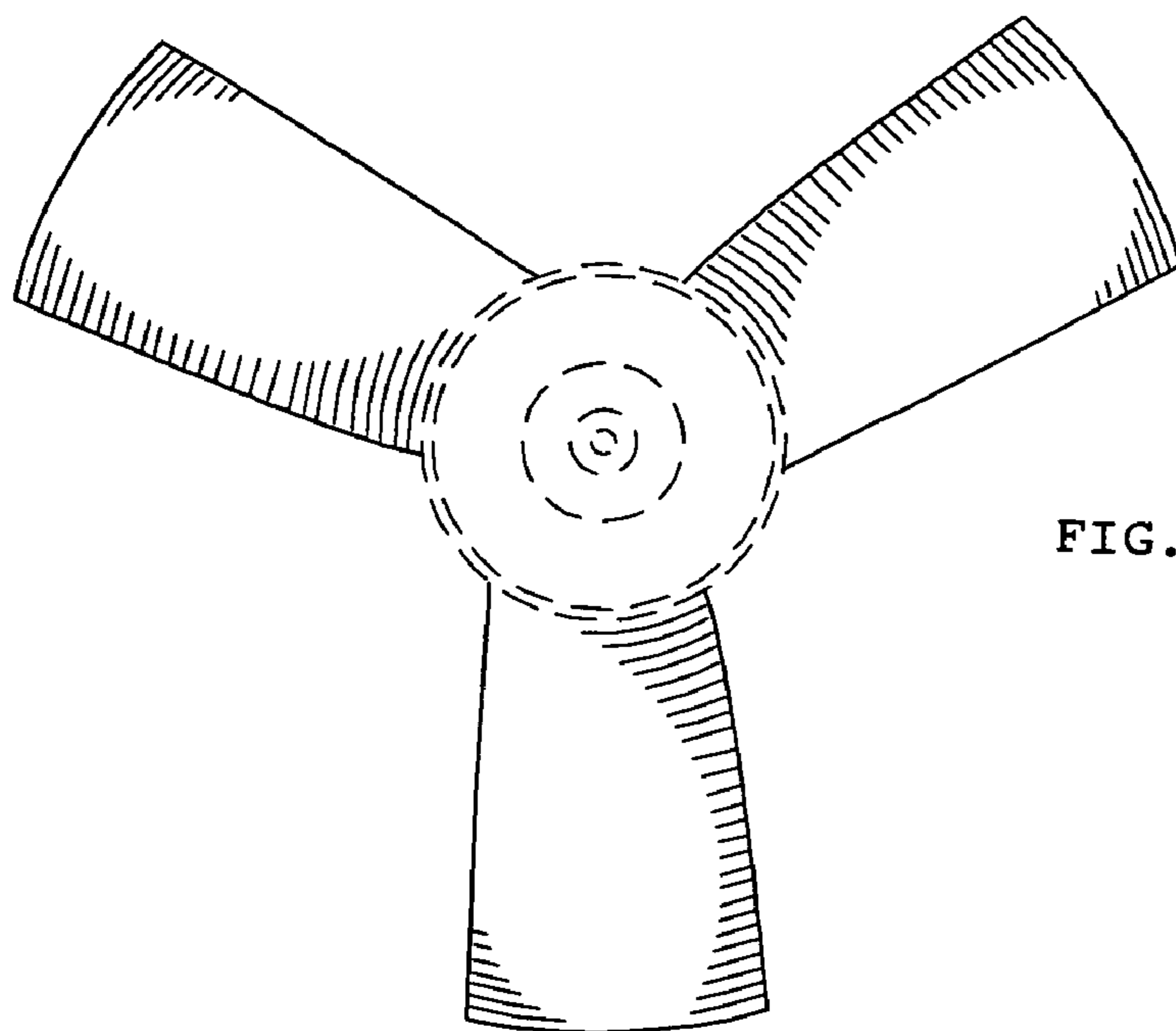

FIG. 12

FIG. 13

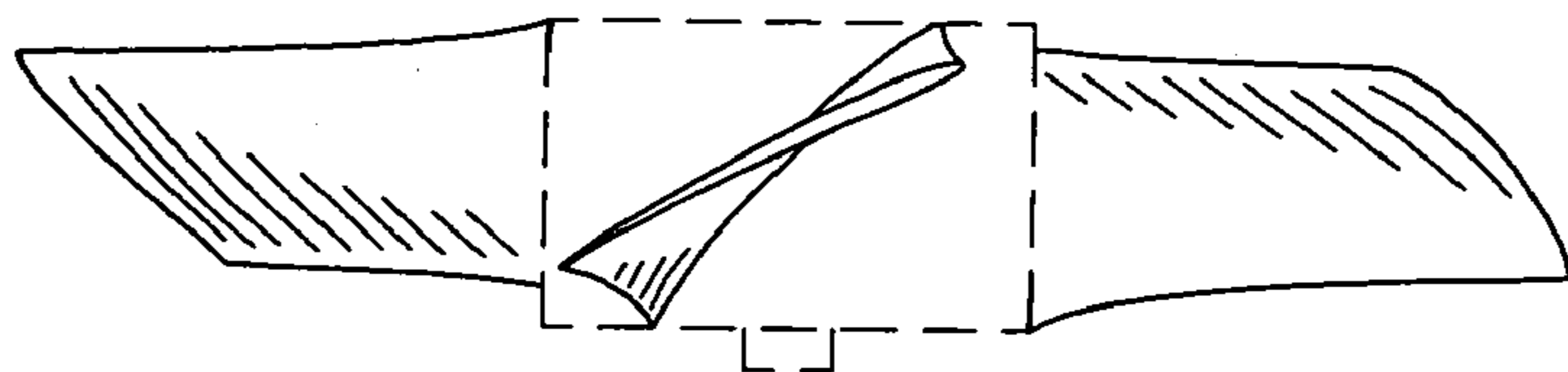

FIG. 14

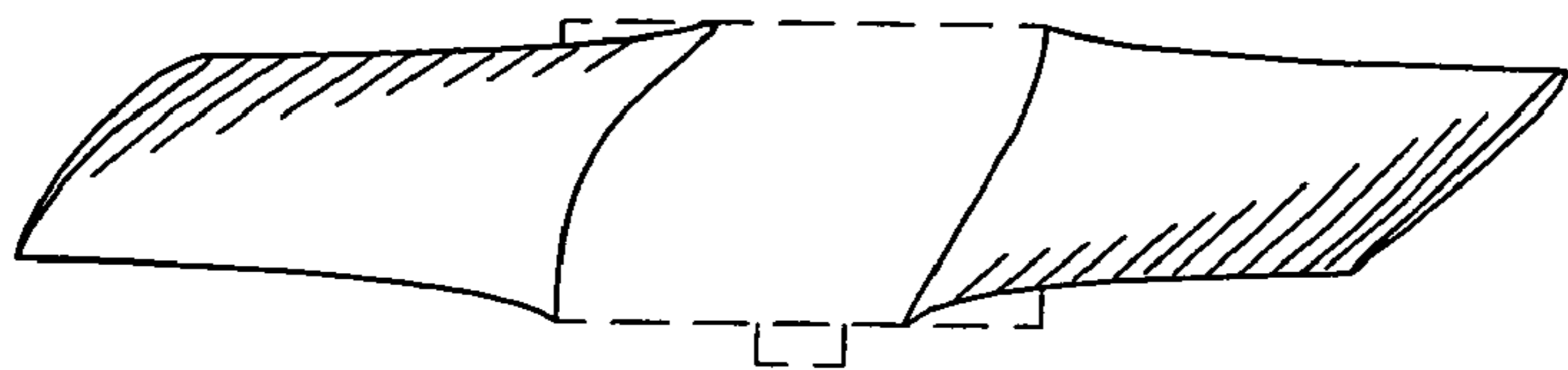

FIG. 15

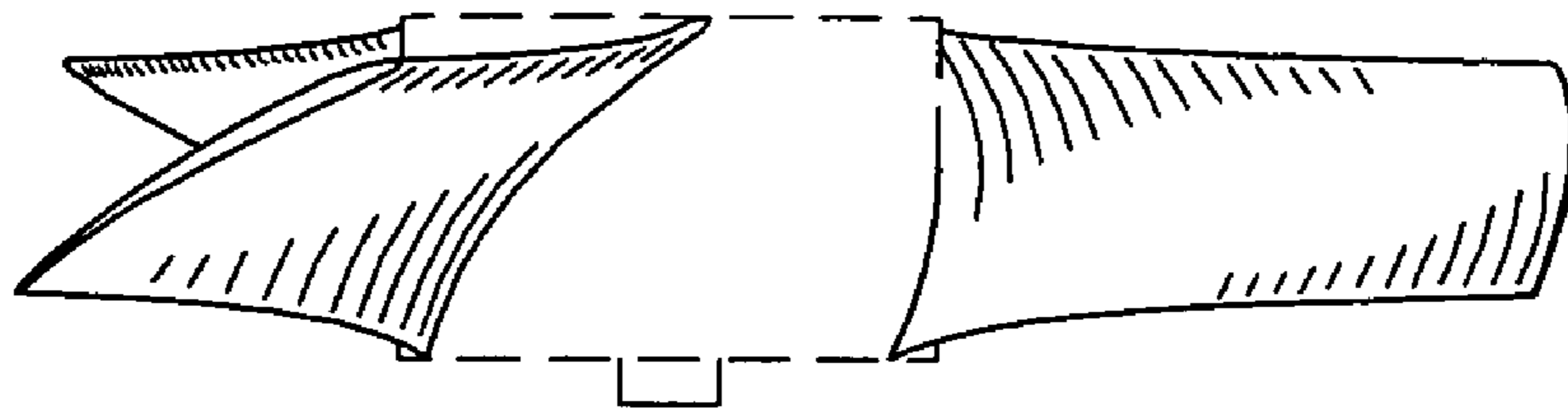

FIG. 16

