



US00D600329S

(12) **United States Design Patent**
Glaze et al.

(10) **Patent No.:** **US D600,329 S**

(45) **Date of Patent:** **** Sep. 15, 2009**

(54) **RING FOR SEALING**

(75) Inventors: **Alan Richard Glaze**, Bromsgrove (GB);
Steven Paul Webb, Tipton (GB)

(73) Assignee: **IBP Conex Limited**, Tipton (GB)

(**) Term: **14 Years**

(21) Appl. No.: **29/332,261**

(22) Filed: **Feb. 11, 2009**

(30) **Foreign Application Priority Data**

Dec. 15, 2008 (EM) 001056626

(51) **LOC (9) Cl.** **23-01**

(52) **U.S. Cl.** **D23/269**

(58) **Field of Classification Search** D23/259–269;
277/602, 608, 625, 626, 910, 165, 27 A, DIG. 23,
277/227; 285/105, 232, 337, 370, 95, 231;
29/446; D8/373, 396

See application file for complete search history.

(56) **References Cited**

U.S. PATENT DOCUMENTS

D32,696	S	*	5/1900	Merwarth et al.	D23/269
D32,697	S	*	5/1900	Merwarth et al.	D23/269
D32,698	S	*	5/1900	Merwarth et al.	D23/269
2,484,693	A	*	10/1949	De Witt, Sr. et al.	277/631
3,740,061	A	*	6/1973	Jensen	277/616
D285,109	S	*	8/1986	Jornhagen	D23/269
D285,247	S	*	8/1986	Jornhagen	D23/269
D322,120	S	*	12/1991	du Gay	D23/269
D323,024	S	*	1/1992	Petersson et al.	D23/269
D351,459	S	*	10/1994	Andersson	D23/269
D368,516	S	*	4/1996	Matsumura	D23/269
D374,710	S	*	10/1996	Gustafsson	D23/269

D391,628	S	*	3/1998	Carwile	D23/269
D465,061	S	*	10/2002	Guthrie	D26/138
D559,095	S	*	1/2008	Lalancette et al.	D8/396

* cited by examiner

Primary Examiner—T. Chase Nelson

Assistant Examiner—Eric L Goodman

(74) *Attorney, Agent, or Firm*—Christensen O'Connor
Johnson & Kindness PLLC

(57) **CLAIM**

The ornamental design for a ring for sealing, as shown and described.

DESCRIPTION

FIG. 1 is an upper front perspective view of a ring for sealing showing our new design;

FIG. 2 is a front elevation view thereof;

FIG. 3 is an enlarged perspective cut away view of a portion of the ring for sealing shown in FIG. 1;

FIG. 4 is a top plan view thereof, with a bottom plan view thereof being identical;

FIG. 5 is a right side elevation view thereof, with a left side elevation view thereof being identical;

FIG. 6 is a cross section view of the ring for sealing shown in FIG. 1, as indicated in FIG. 2; and,

FIG. 7 is another cross section view thereof, as indicated in FIG. 2.

The ring for sealing depicted in FIGS. 1–7 has a non-circular cross section with a flattened part of the radial inside of the ring along the majority of the ring circumference. Two second portions each comprise a recess between two projections.

1 Claim, 5 Drawing Sheets

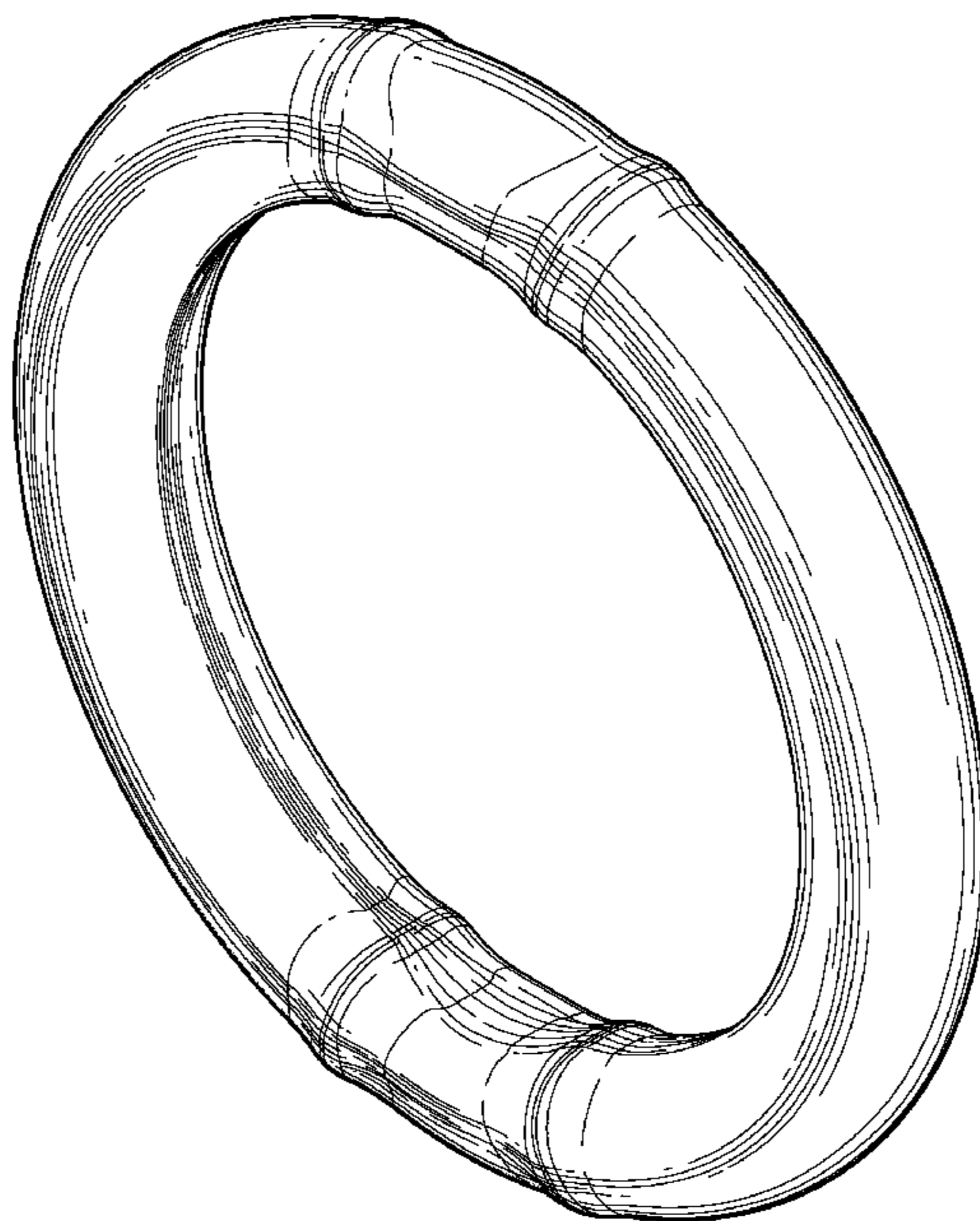

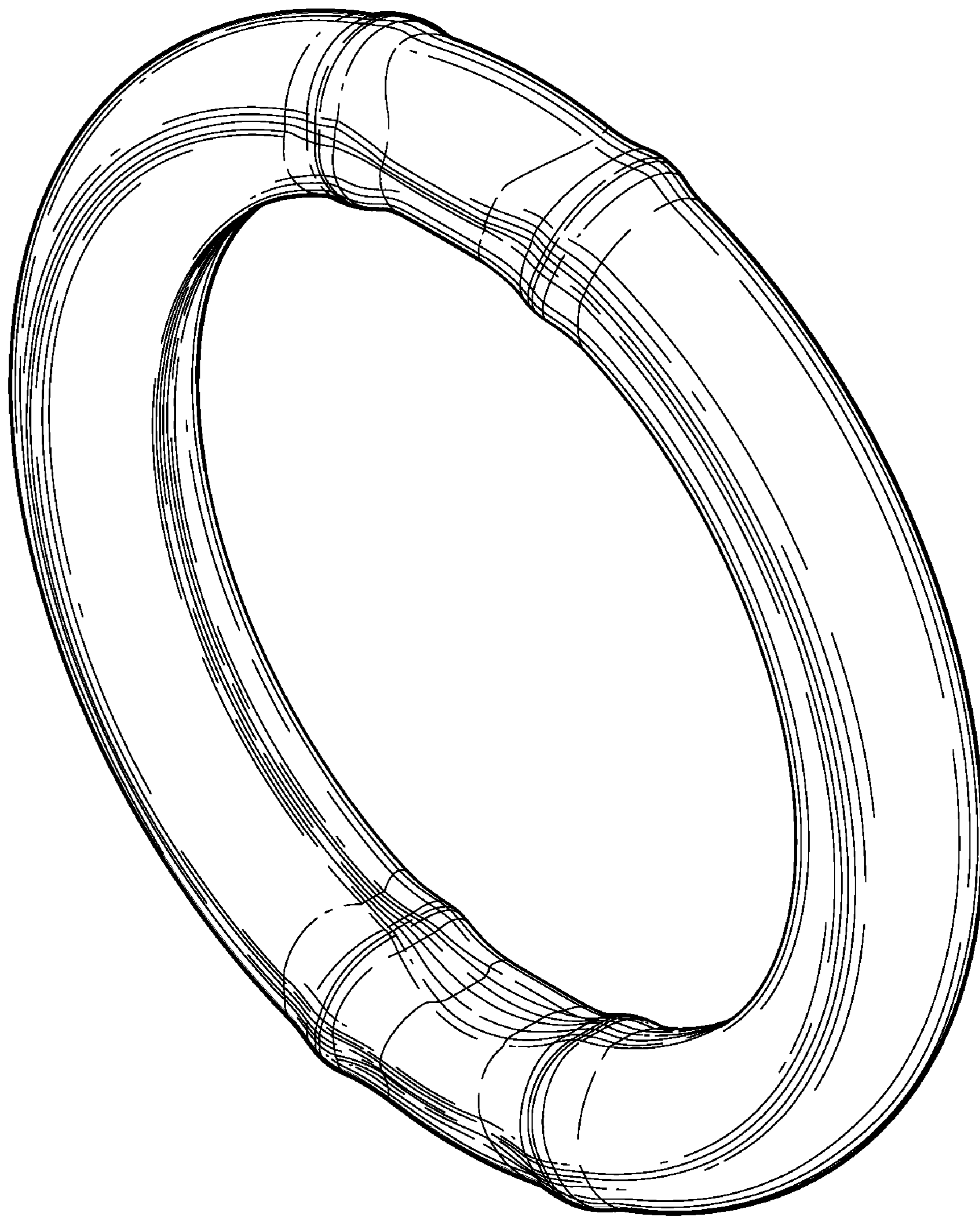

Fig. 1.

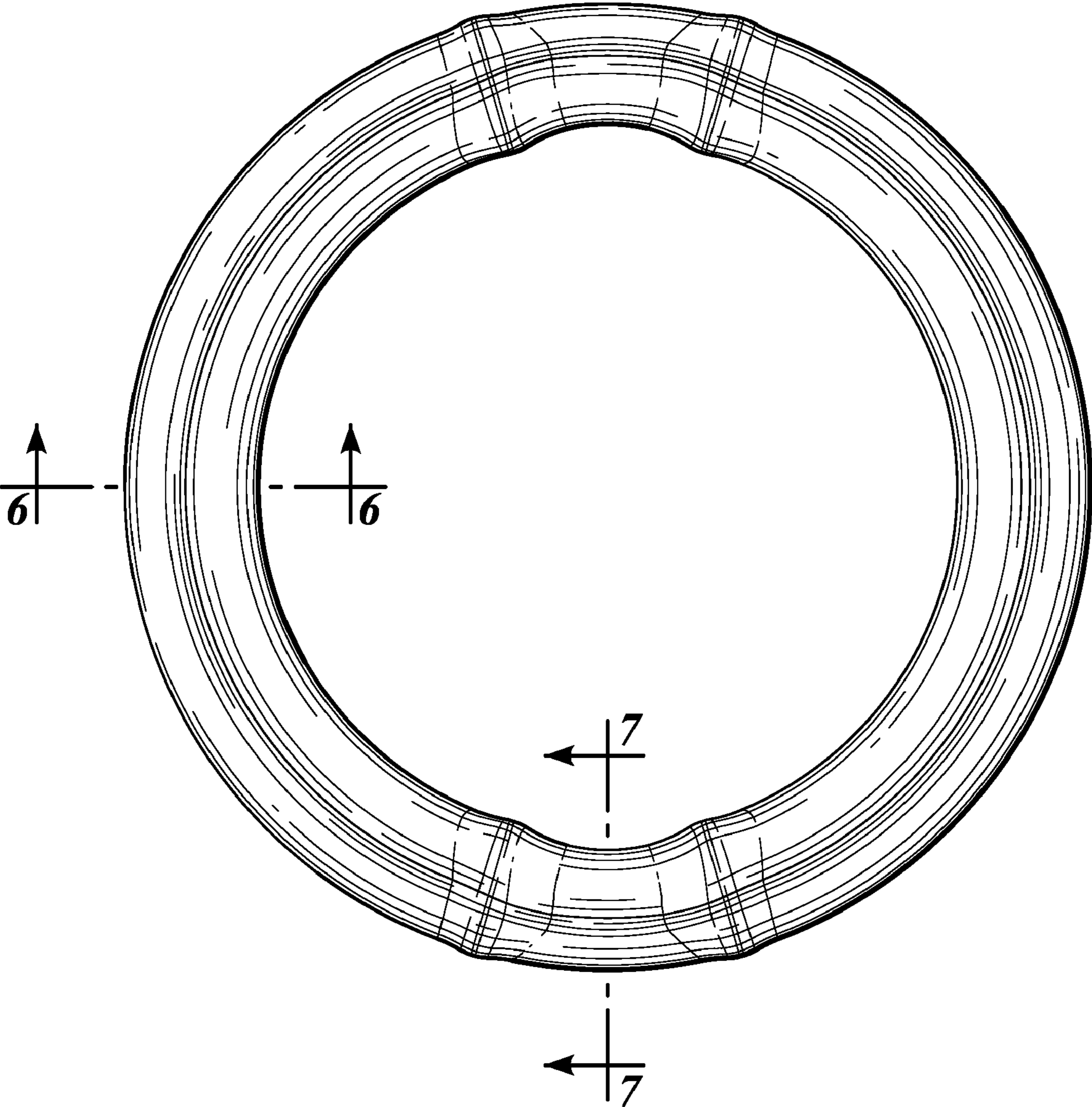

Fig. 2.

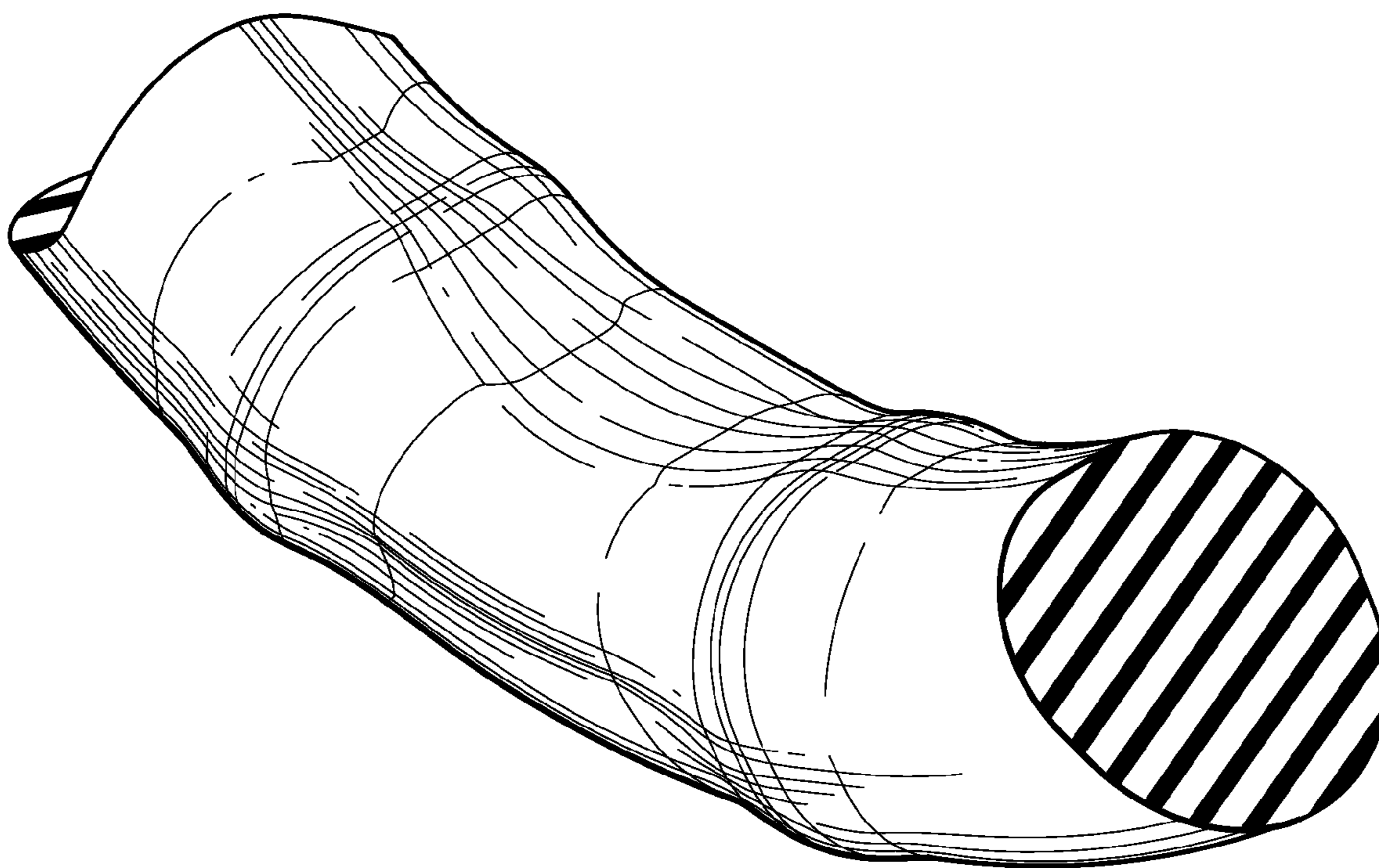

Fig.3.

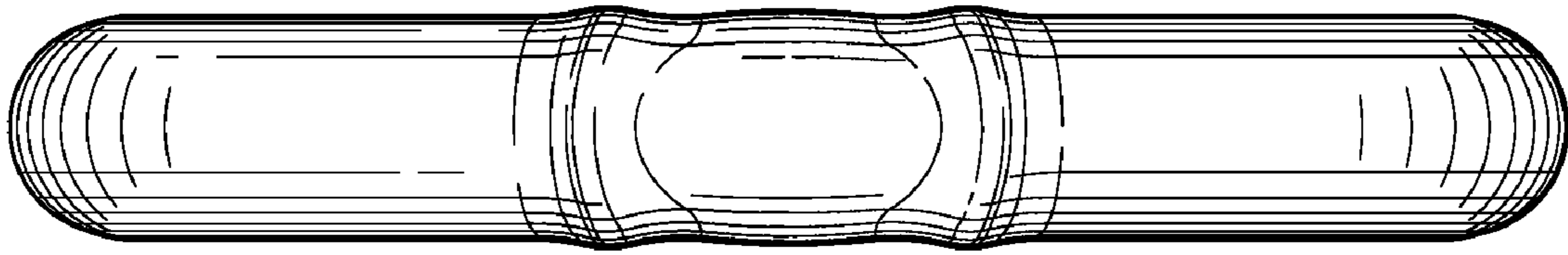

Fig. 4.

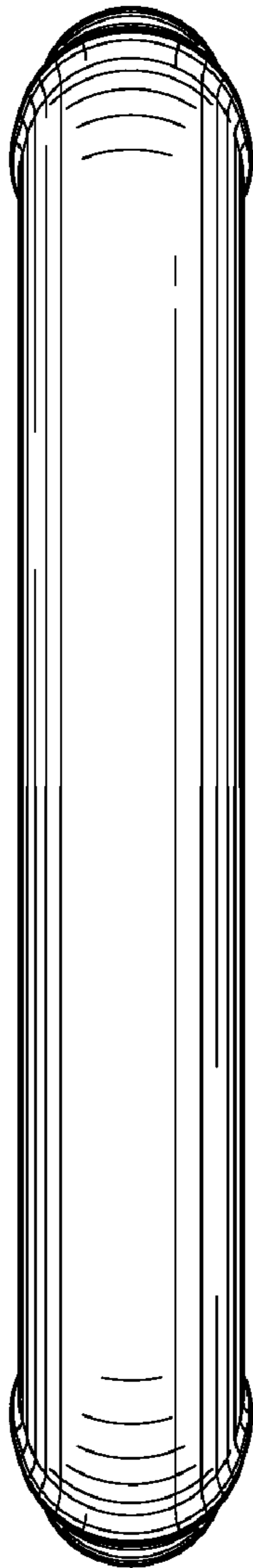

Fig. 5.

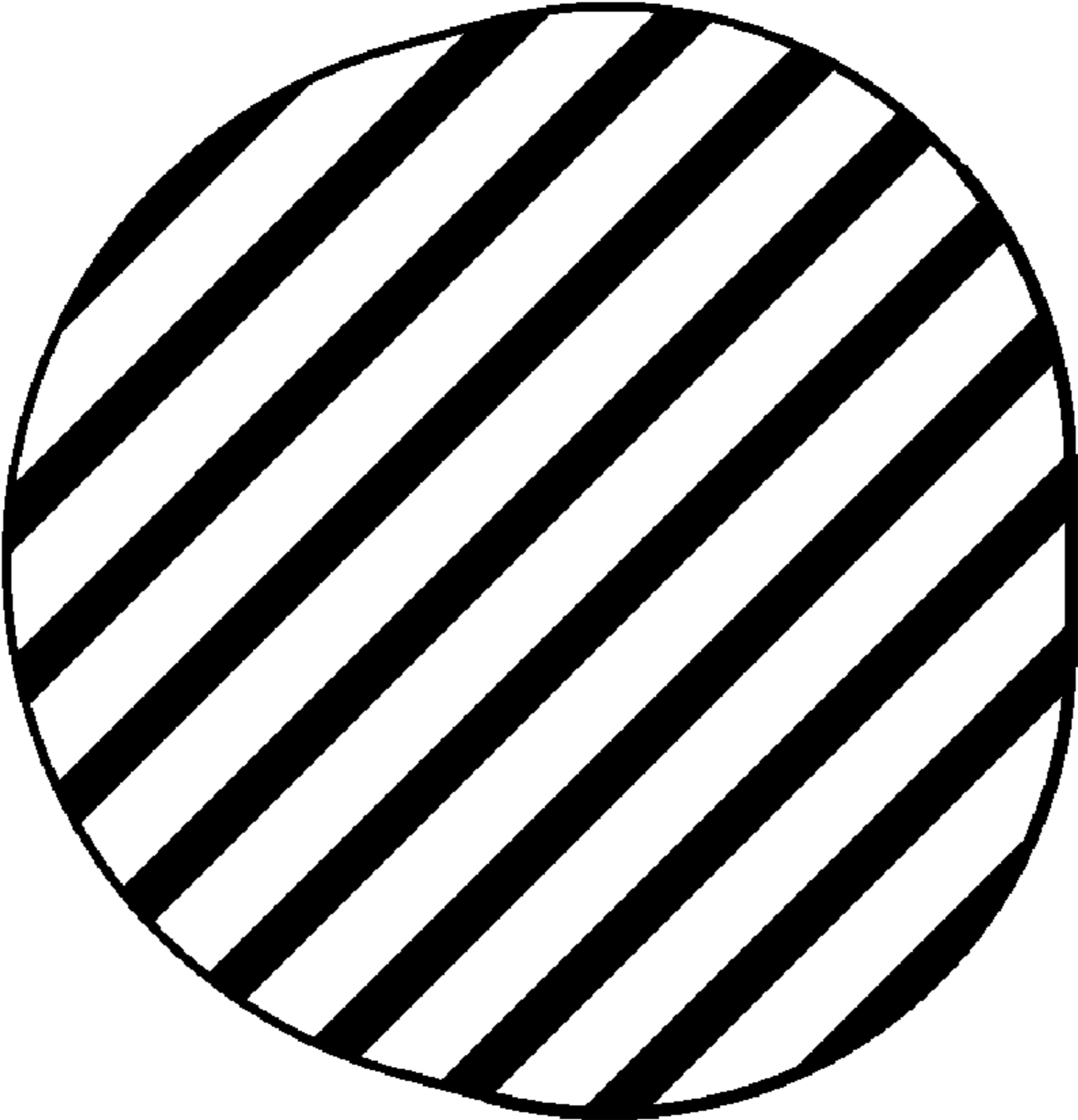

Fig. 6.

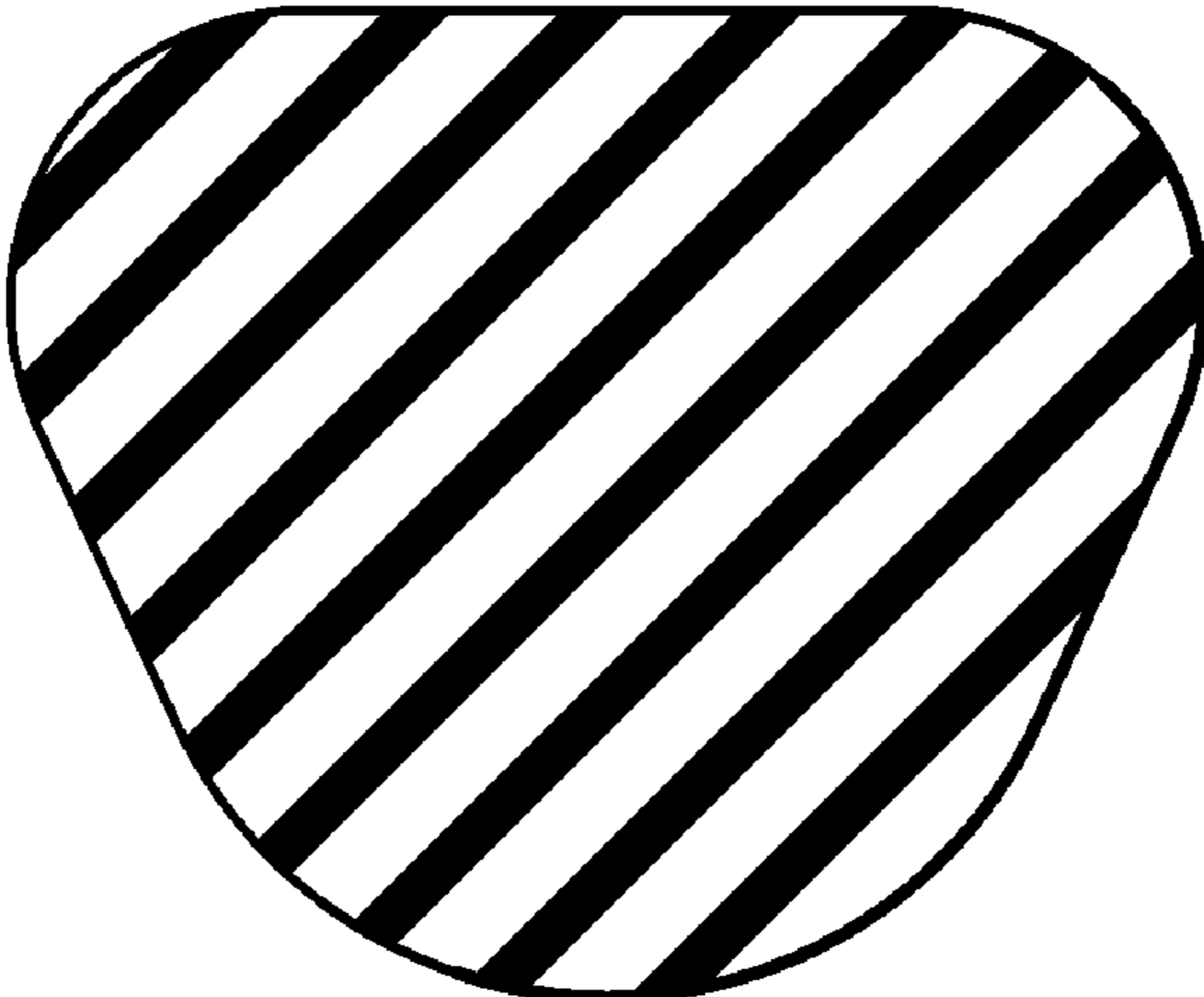

Fig. 7.