



US00D600261S

(12) **United States Design Patent**
Raineri

(10) **Patent No.:** **US D600,261 S**

(45) **Date of Patent:** **** Sep. 15, 2009**

(54) **REMOTE GREASE FITTING**

(76) Inventor: **Martin Raineri**, 11703 Park Haven Ct.,
St. Louis, MI (US) 63126

(**) Term: **14 Years**

(21) Appl. No.: **29/334,754**

(22) Filed: **Mar. 31, 2009**

(51) **LOC (9) Cl.** **15-99**

(52) **U.S. Cl.** **D15/150**

(58) **Field of Classification Search** D8/14.1,
D8/29.1; D15/150-152, 199; 137/539; 184/105.1,
184/105.2, 105.3; 222/262
See application file for complete search history.

(56) **References Cited**

U.S. PATENT DOCUMENTS

1,307,734	A *	6/1919	Gullborg	141/382
4,137,998	A *	2/1979	Kusada	184/14
D260,597	S *	9/1981	Mathuda	D8/14.1
4,380,922	A *	4/1983	Kowal	72/388
4,508,372	A *	4/1985	White	285/148.15
4,946,077	A *	8/1990	Olsen	222/256
5,343,982	A *	9/1994	Min	184/28
D375,967	S *	11/1996	Michener	D15/150
D388,801	S *	1/1998	Simard	D15/150
D390,579	S *	2/1998	Michener	D15/150

D409,059	S *	5/1999	Wilson et al.	D8/14.1
D427,864	S *	7/2000	Kowalchik et al.	D8/14.1
D510,242	S *	10/2005	Chen	D8/14.1
D523,303	S *	6/2006	Amin	D8/14.1
2005/0258005	A1 *	11/2005	Chen	184/105.2
2006/0070812	A1 *	4/2006	Eggleton	184/105.2

* cited by examiner

Primary Examiner—Sandra Snapp

Assistant Examiner—Patricia Palasik

(74) *Attorney, Agent, or Firm*—QuickPatents, Inc.; Kevin Prince

(57) **CLAIM**

I claim the ornamental design for a remote grease fitting, as shown and described.

DESCRIPTION

FIG. 1 is a perspective view of a remote grease fitting, showing my new design;

FIG. 2 is a right side elevational view thereof;

FIG. 3 is a left side elevational view thereof;

FIG. 4 is a front elevational view with the rear elevational view being a mirror image thereof;

FIG. 5 is a top plan view thereof; and,

FIG. 6 is a bottom plan view thereof.

1 Claim, 2 Drawing Sheets

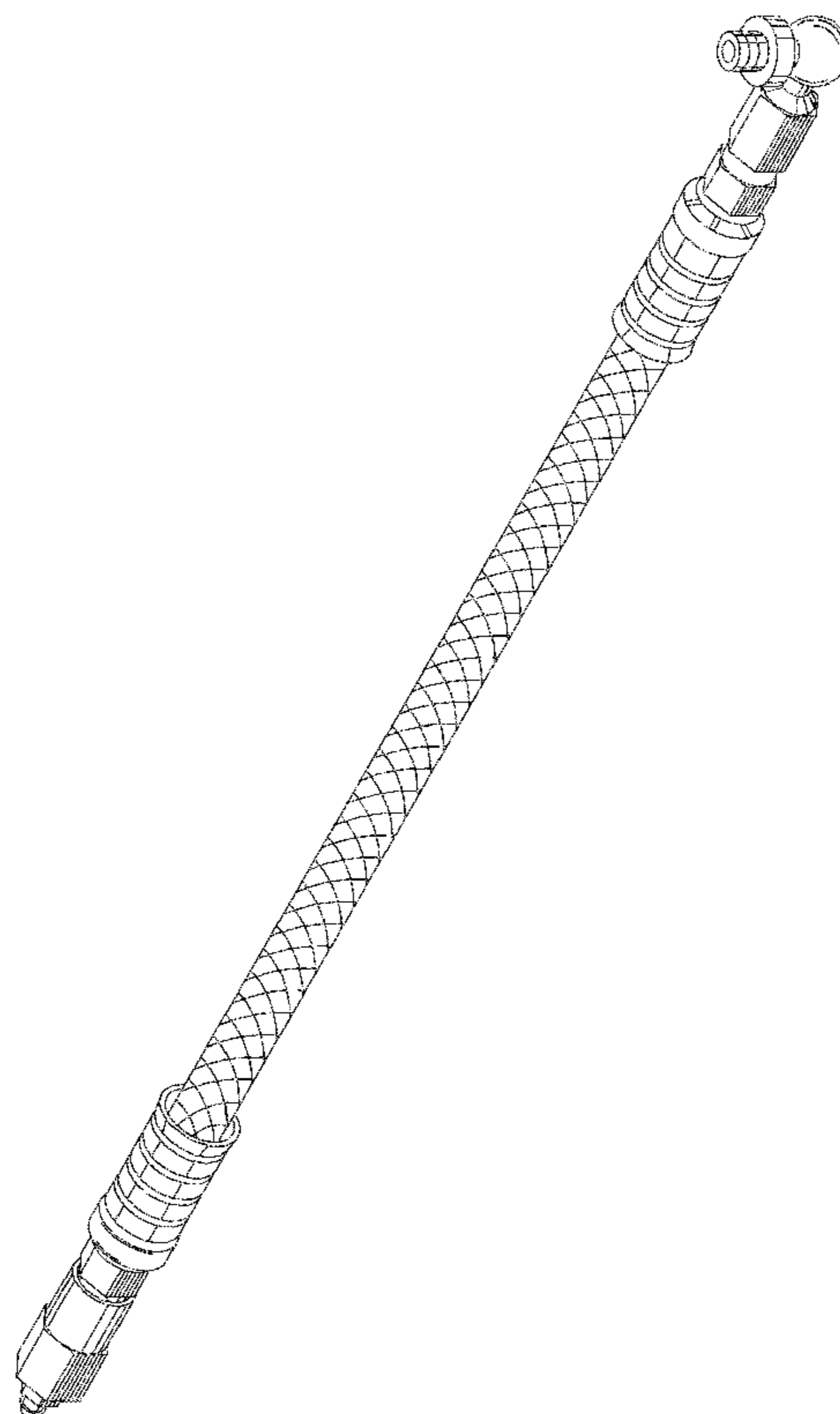

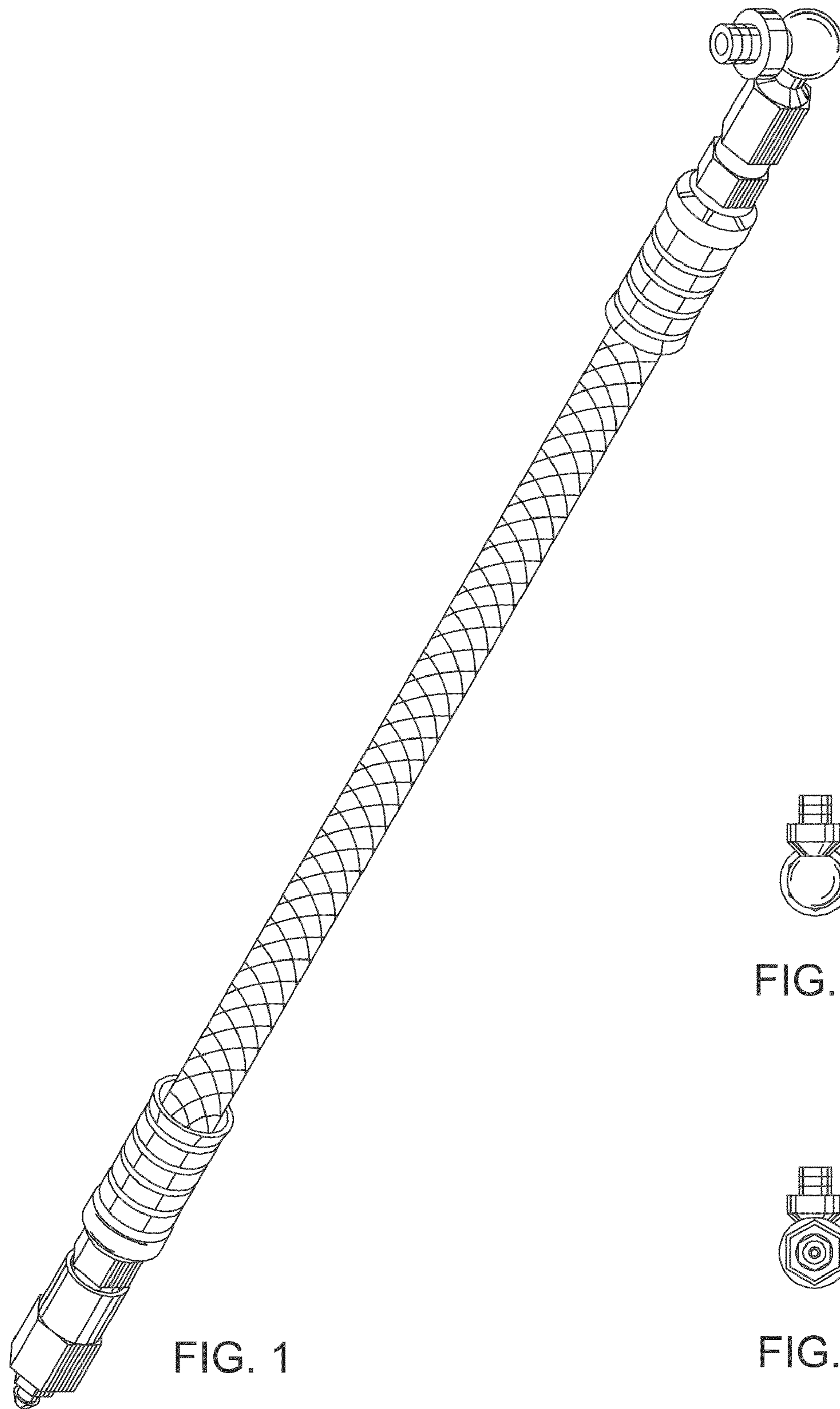

FIG. 1

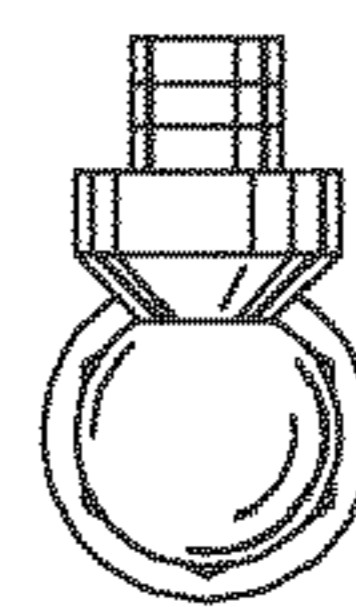

FIG. 2

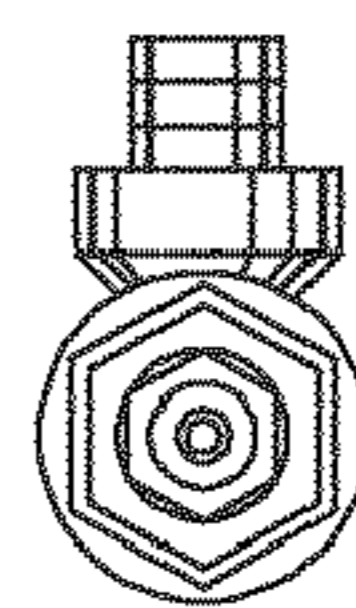

FIG. 3

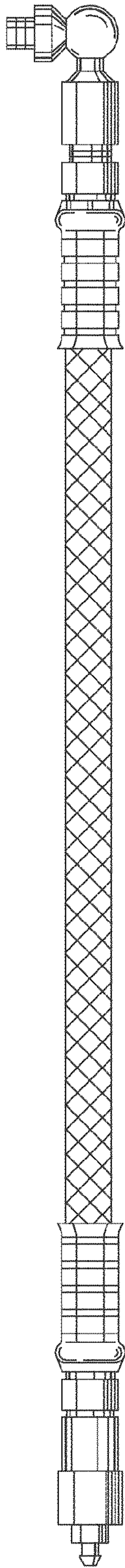

FIG. 4

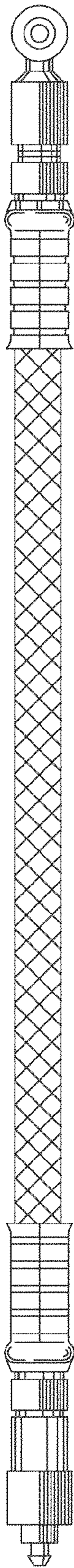

FIG. 5

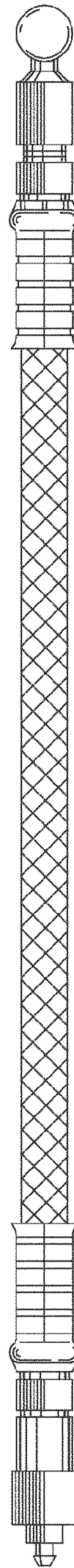

FIG. 6