



US00D600260S

(12) **United States Design Patent**
Frejd

(10) **Patent No.:** **US D600,260 S**

(45) **Date of Patent:** **** Sep. 15, 2009**

(54) **DRILLING TOOL**

(75) Inventor: **Stefan Frejd**, Söderköping (SE)

(73) Assignee: **Seco Tools AB**, Fagersta (SE)

(**) Term: **14 Years**

(21) Appl. No.: **29/332,991**

(22) Filed: **Feb. 28, 2009**

Related U.S. Application Data

(62) Division of application No. 29/326,166, filed on Oct. 14, 2008, now Pat. No. Des. 590,851.

(51) **LOC (9) Cl.** **15-09**

(52) **U.S. Cl.** **D15/139**

(58) **Field of Classification Search** D8/70;
D15/138, 139, 140; 83/845; 403/331, 381;
407/9, 33, 34, 42, 54, 63, 110, 113, 114,
407/115; 408/224, 226-230

See application file for complete search history.

(56) **References Cited**

U.S. PATENT DOCUMENTS

5,971,673	A *	10/1999	Berglund et al.	408/1 R
6,238,151	B1 *	5/2001	Takagi	408/230
6,948,891	B2 *	9/2005	Roman	408/223
7,070,010	B2 *	7/2006	Papousek	175/415
7,134,816	B2 *	11/2006	Brink	408/226
7,422,396	B2 *	9/2008	Takikawa	408/59

2002/0015623	A1 *	2/2002	Eriksson	407/53
2004/0134688	A1 *	7/2004	Papousek	175/415
2005/0271482	A1 *	12/2005	Volokh	407/34
2006/0029477	A1 *	2/2006	Anjanappa et al.	408/230
2006/0032676	A1 *	2/2006	Papousek	175/415
2007/0009336	A1 *	1/2007	Lenander	408/230
2008/0166196	A1 *	7/2008	Zhu	408/230
2008/0181737	A1 *	7/2008	Limell et al.	408/188

* cited by examiner

Primary Examiner—Sandra Snapp

Assistant Examiner—Patricia Palasik

(74) *Attorney, Agent, or Firm*—WRB-IP LLP

(57) **CLAIM**

The ornamental design for drilling tools, as shown and described.

DESCRIPTION

FIG. 1 is a side view of a drilling tool according to an embodiment of the present invention;

FIG. 2 is a side view of the drilling tool of FIG. 1 turned 90° about its axis;

FIG. 3 is a top, perspective view of the drilling tool;

FIG. 4 is a top, perspective view of the drilling tool;

FIG. 5 is a bottom, perspective view of the drilling tool;

FIG. 6 is a bottom, perspective view of the drilling tool; and,

FIG. 7 is a top view of the drilling tool.

1 Claim, 3 Drawing Sheets

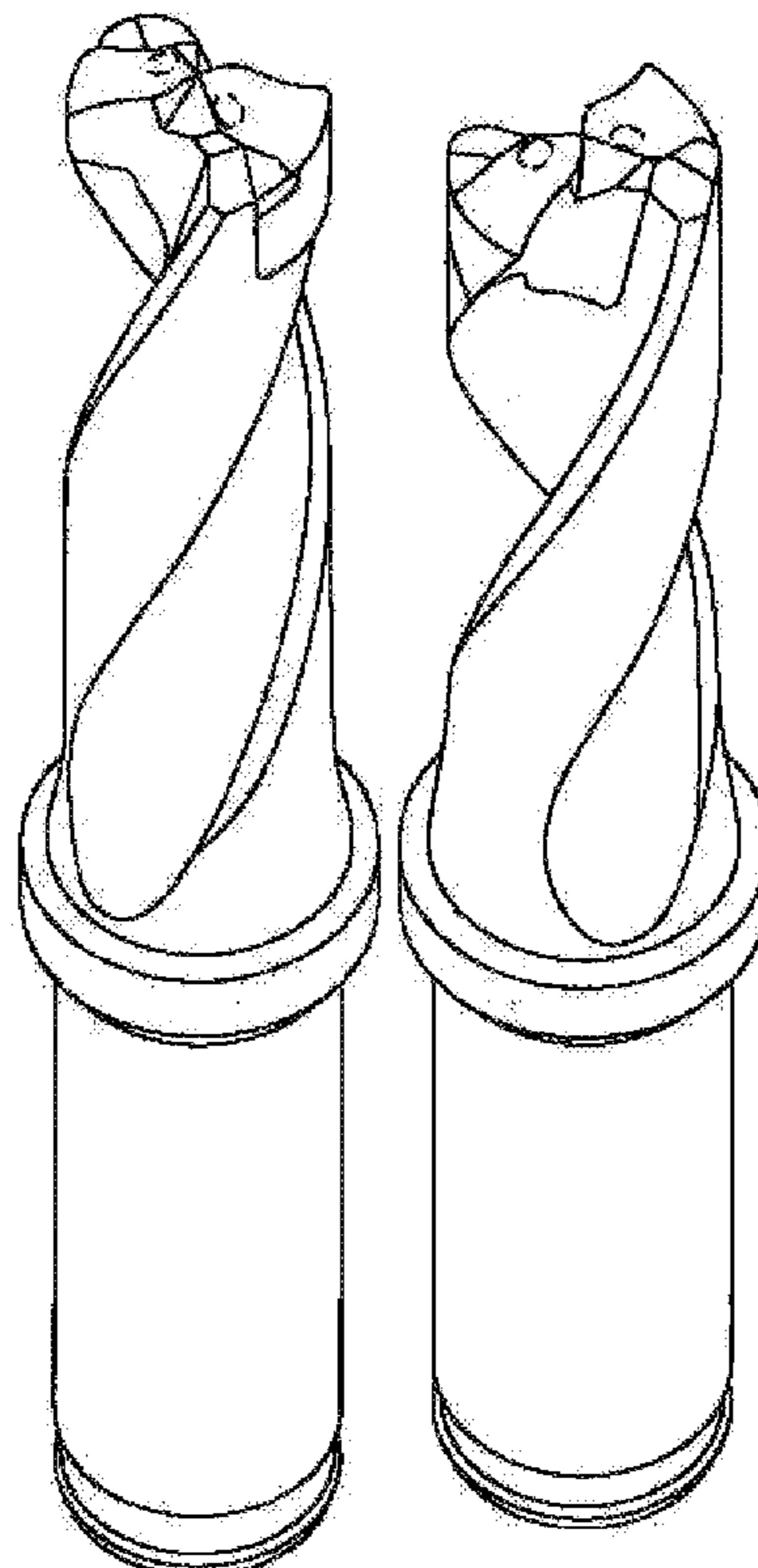

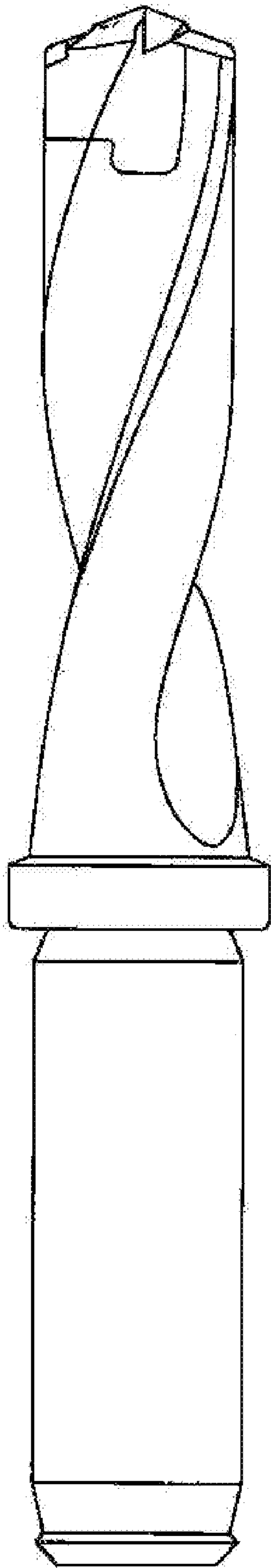

FIG. 1

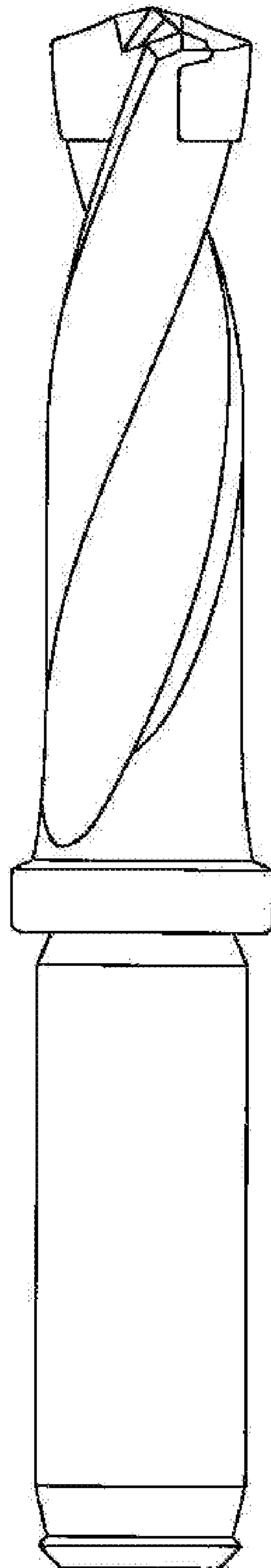

FIG. 2

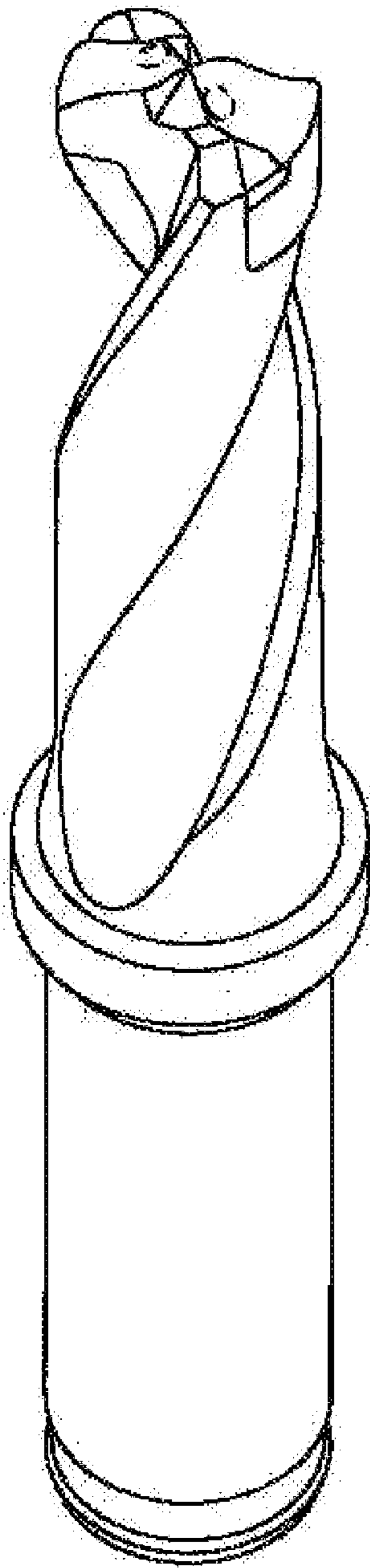

FIG. 3

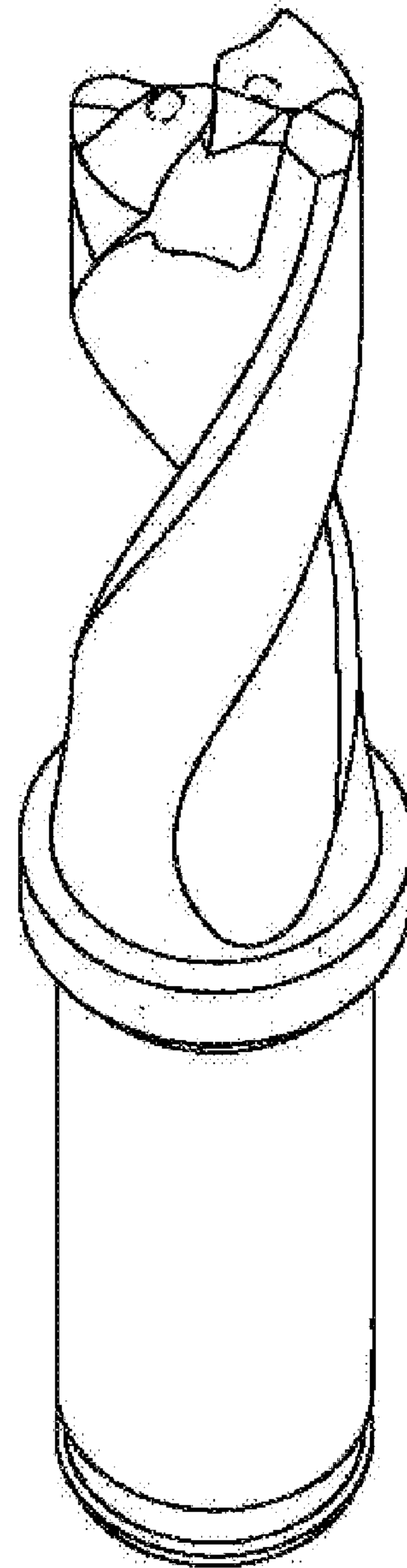

FIG. 4

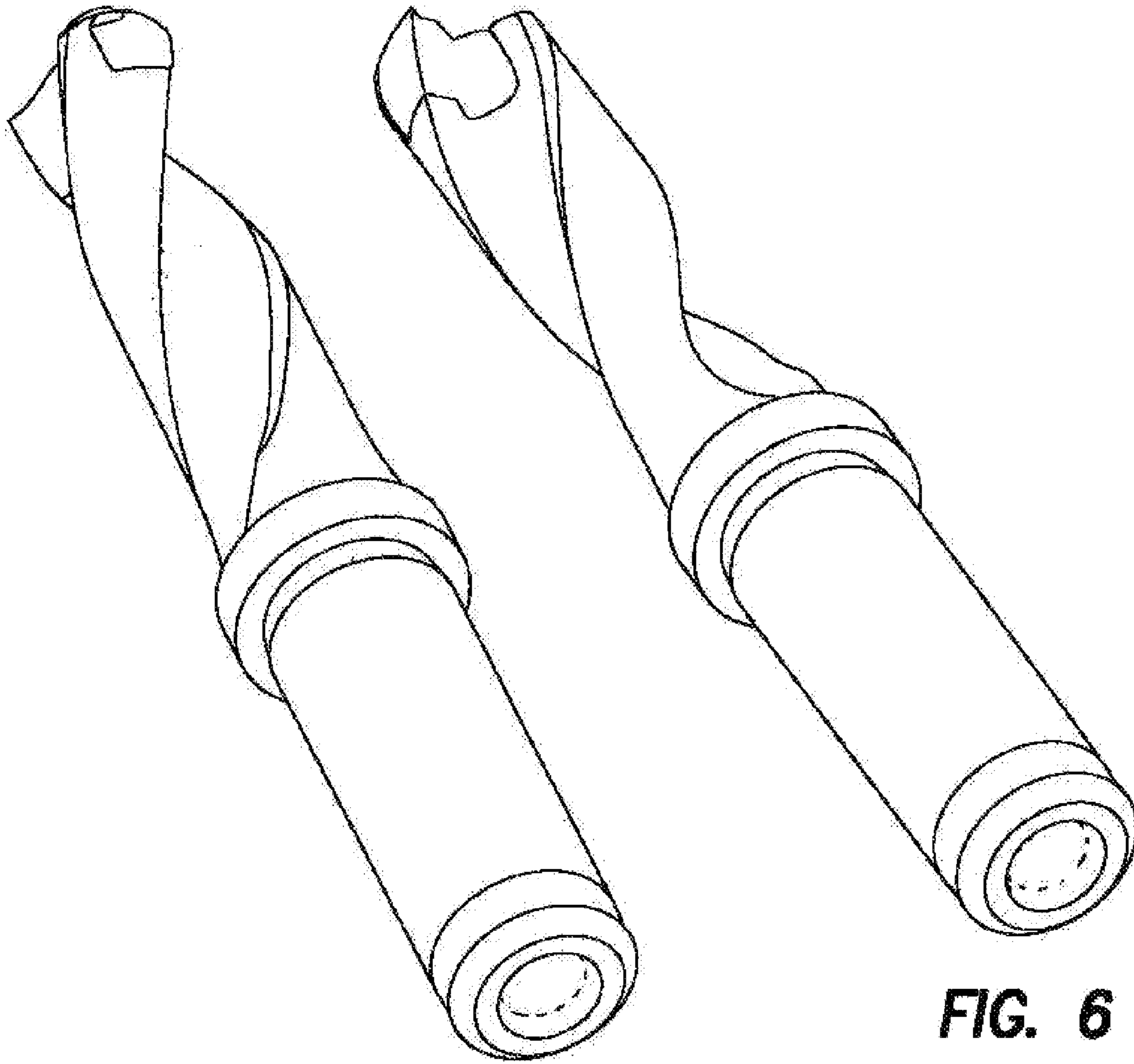

FIG. 5

FIG. 6

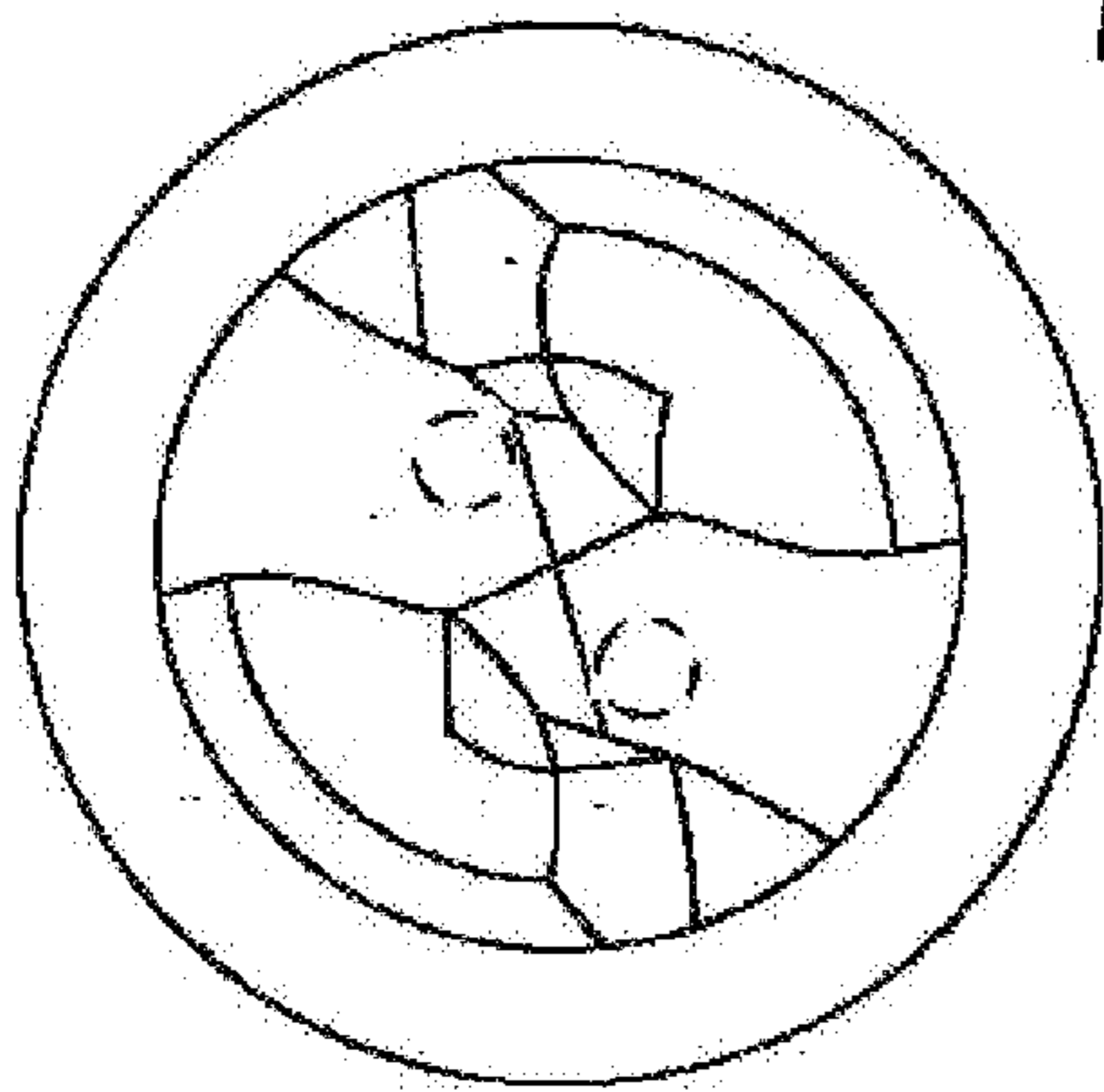

FIG. 7