



US00D600234S

(12) **United States Design Patent**  
**Suzuki**

(10) **Patent No.:** **US D600,234 S**  
(45) **Date of Patent:** **\*\* Sep. 15, 2009**

- (54) **SPEAKER**
- (75) Inventor: **Satoshi Suzuki**, Tokyo (JP)
- (73) Assignee: **Sony Corporation**, Tokyo (JP)
- (\*\*) Term: **14 Years**
- (21) Appl. No.: **29/309,727**
- (22) Filed: **Sep. 30, 2008**

JP	D1276067 S	7/2006
JP	D1276321 S	7/2006
JP	D1317610 S	12/2007

(30) **Foreign Application Priority Data**

Jun. 20, 2008	(JP)	.....	D2008-015852
Jun. 20, 2008	(JP)	.....	D2008-015907

- (51) **LOC (9) Cl.** ..... **14-01**
- (52) **U.S. Cl.** ..... **D14/214**
- (58) **Field of Classification Search** ..... D14/204,  
D14/207, 210–216, 172; 181/143–144, 147–148,  
181/150–153, 157, 198–199; 381/300–303,  
381/306, 332–333, 336, 345, 361–364, 386–388  
See application file for complete search history.

(56) **References Cited**

**U.S. PATENT DOCUMENTS**

D230,489 S	*	2/1974	Everitt	.....	D14/214
D335,497 S	*	5/1993	Patterson et al.	.....	D14/211
D401,583 S	*	11/1998	Shin et al.	.....	D14/214
D417,874 S	*	12/1999	Suzuki	.....	D14/215
D420,357 S		2/2000	Matsuoka		
D421,754 S	*	3/2000	Ito et al.	.....	D14/214
D448,752 S	*	10/2001	Matsuoka	.....	D14/214
D460,750 S		7/2002	Matsuoka		
D467,898 S	*	12/2002	Matsuoka	.....	D14/214
D508,690 S	*	8/2005	Hioki	.....	D14/214
D510,338 S	*	10/2005	Brimhall et al.	.....	D14/214
D519,987 S		5/2006	Kubota		
D532,771 S		11/2006	Motoishi		
D558,184 S		12/2007	Carbone et al.		

**FOREIGN PATENT DOCUMENTS**

JP D1241442 S 6/2005

**OTHER PUBLICATIONS**

Catalog, Bose Owner's Manual, Multimedia Speaker System Companion® 2 series II, 12 pages, Bose Corporation (Mar. 2008).  
Catalog, Model Companion® 2 series II/series II Black, 2 pages, No. S-0190, Bose Corporation (Dec. 2006).

\* cited by examiner

*Primary Examiner*—Nanda Bondade  
(74) *Attorney, Agent, or Firm*—Rader, Fishman & Grauer, PLLC

(57) **CLAIM**

The ornamental design for a speaker, as shown and described.

**DESCRIPTION**

FIG. 1 is a perspective view of a speaker showing our new design;

FIG. 2 is a front elevational view thereof;

FIG. 3 is a rear elevational view thereof.

FIG. 4 is a left side elevational view thereof;

FIG. 5 is a right side elevational view thereof;

FIG. 6 is a top plan view thereof;

FIG. 7 is a bottom plan view thereof;

FIG. 8 is a front elevational view thereof, showing a line 9—9; and,

FIG. 9 is an enlarged partial view taken along a line 9—9 of FIG. 8.

The das-dot lines which define the bounds of the claimed design form no part thereof.

**1 Claim, 9 Drawing Sheets**

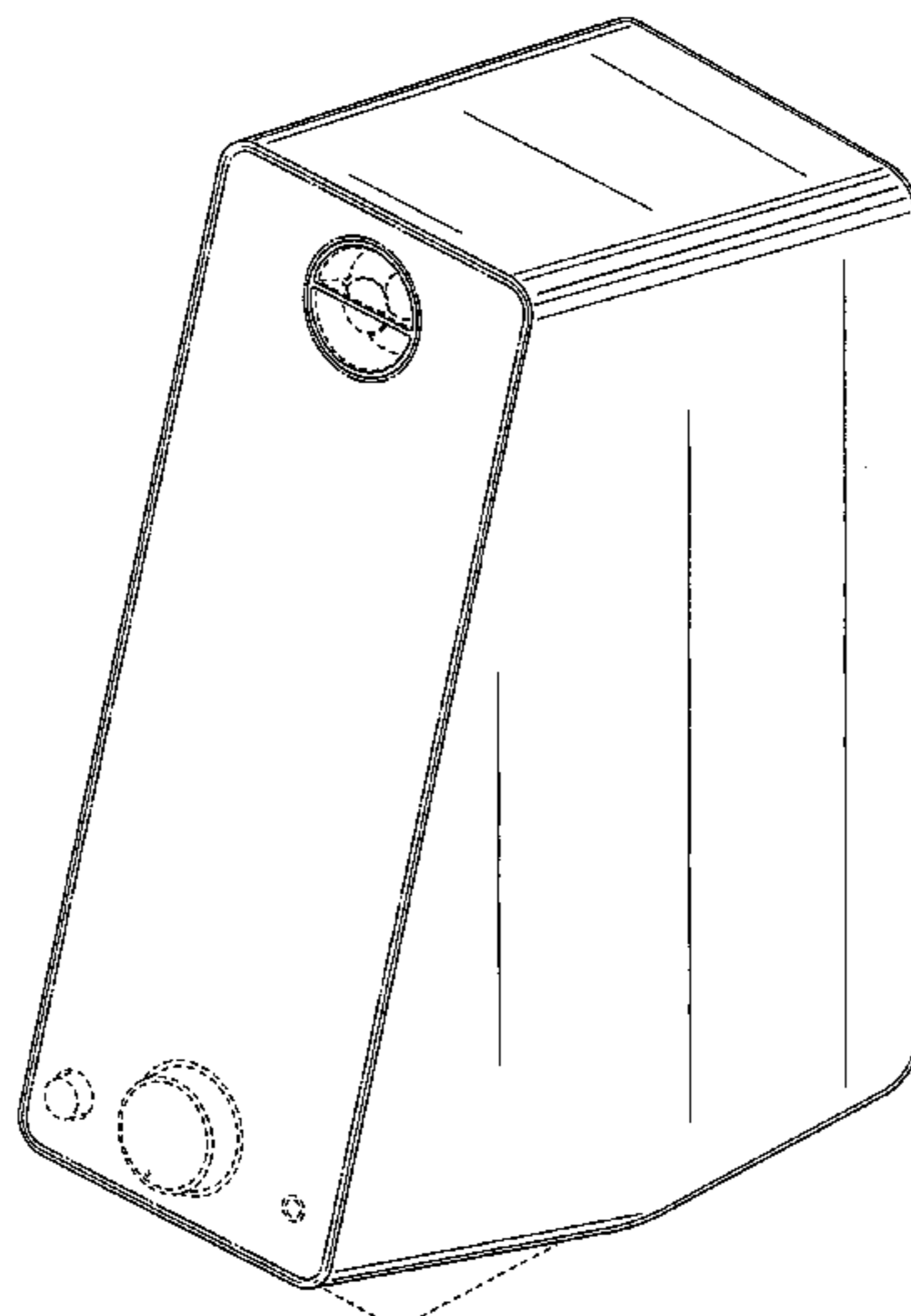

FIG.1

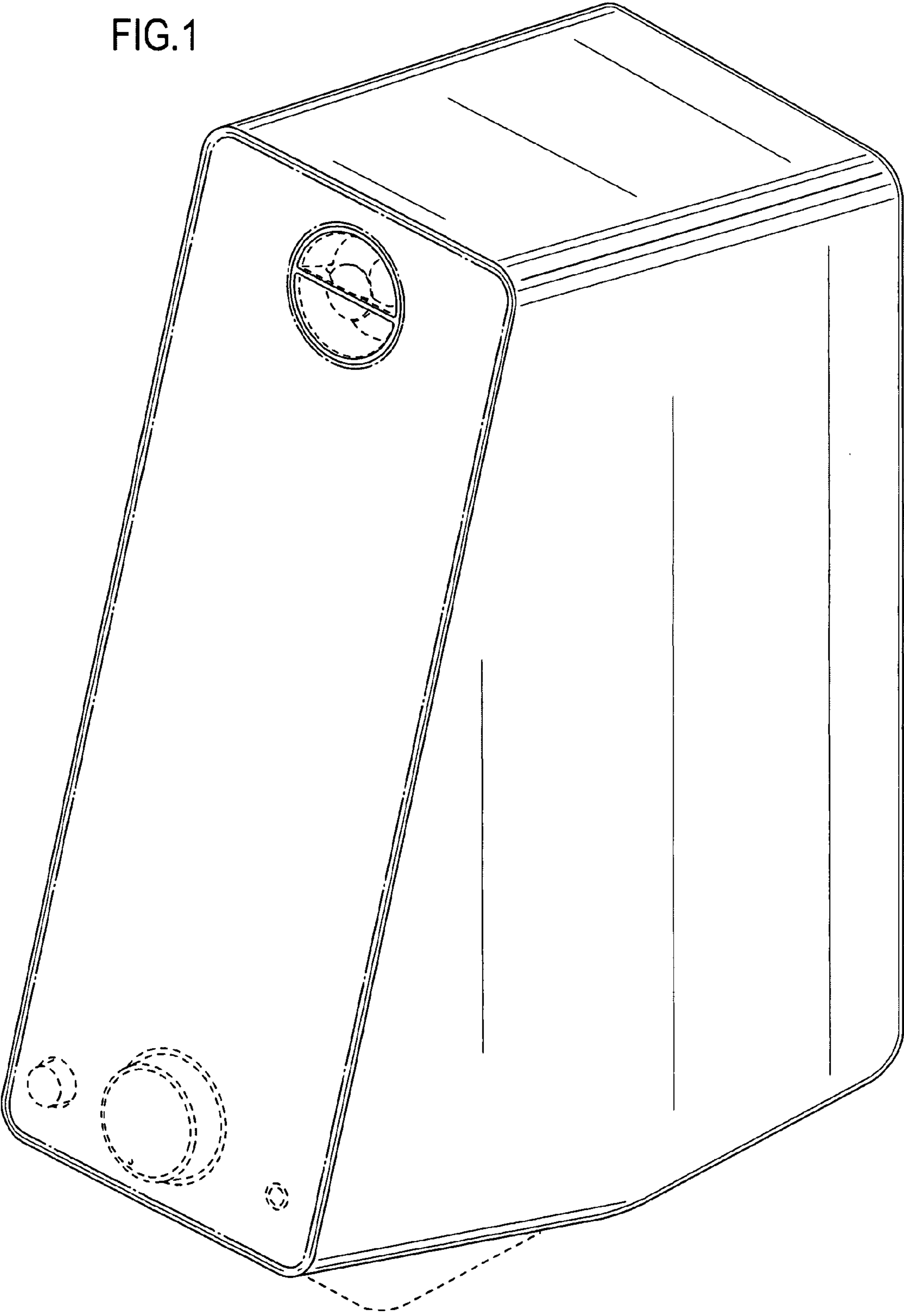

FIG.2

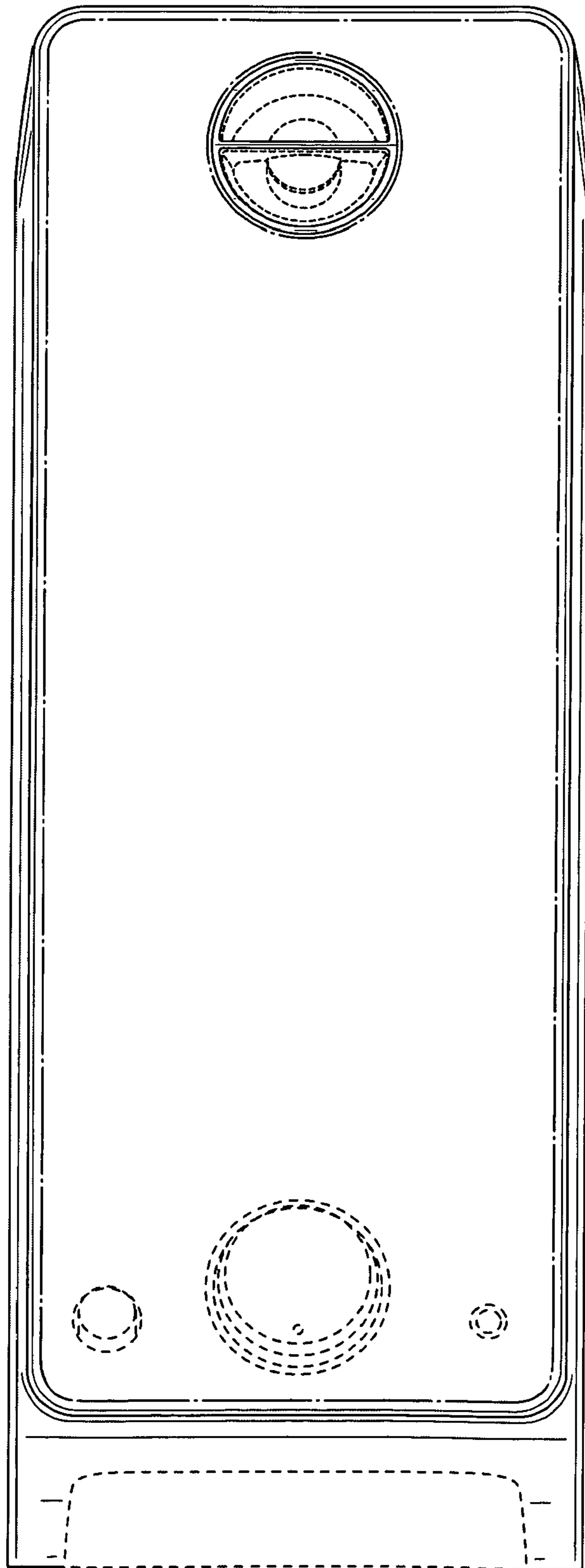

FIG.3

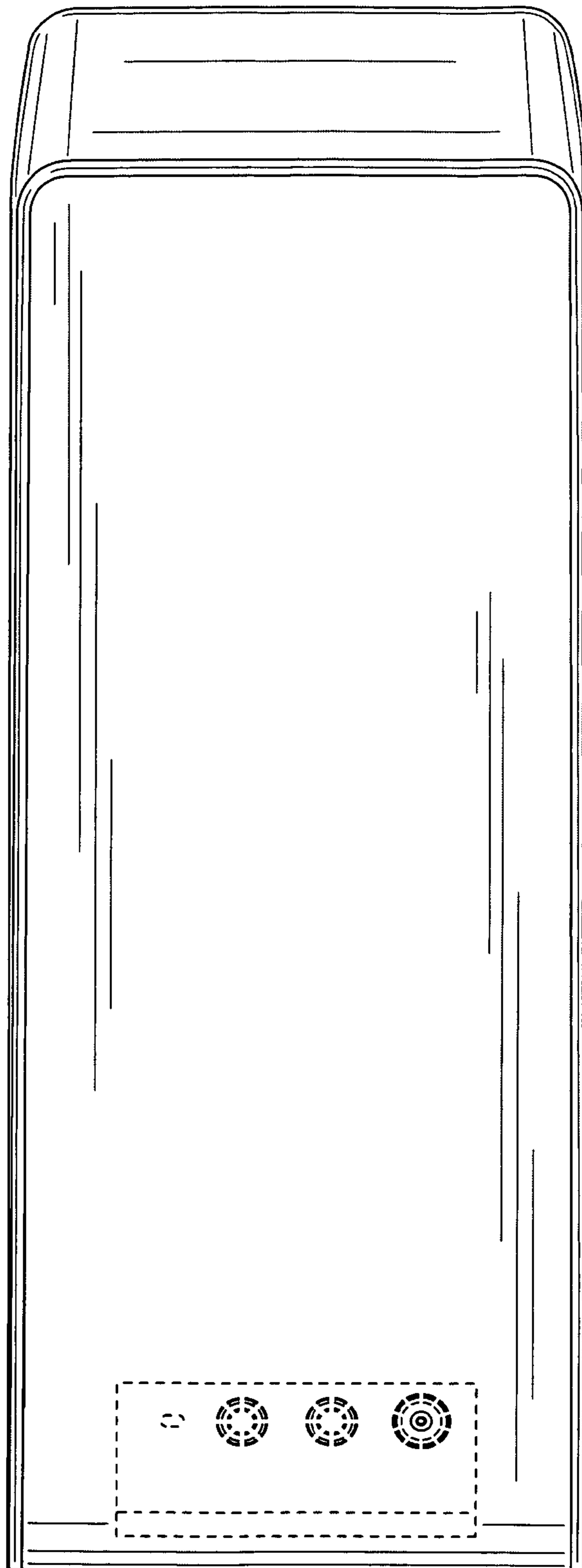

FIG.4

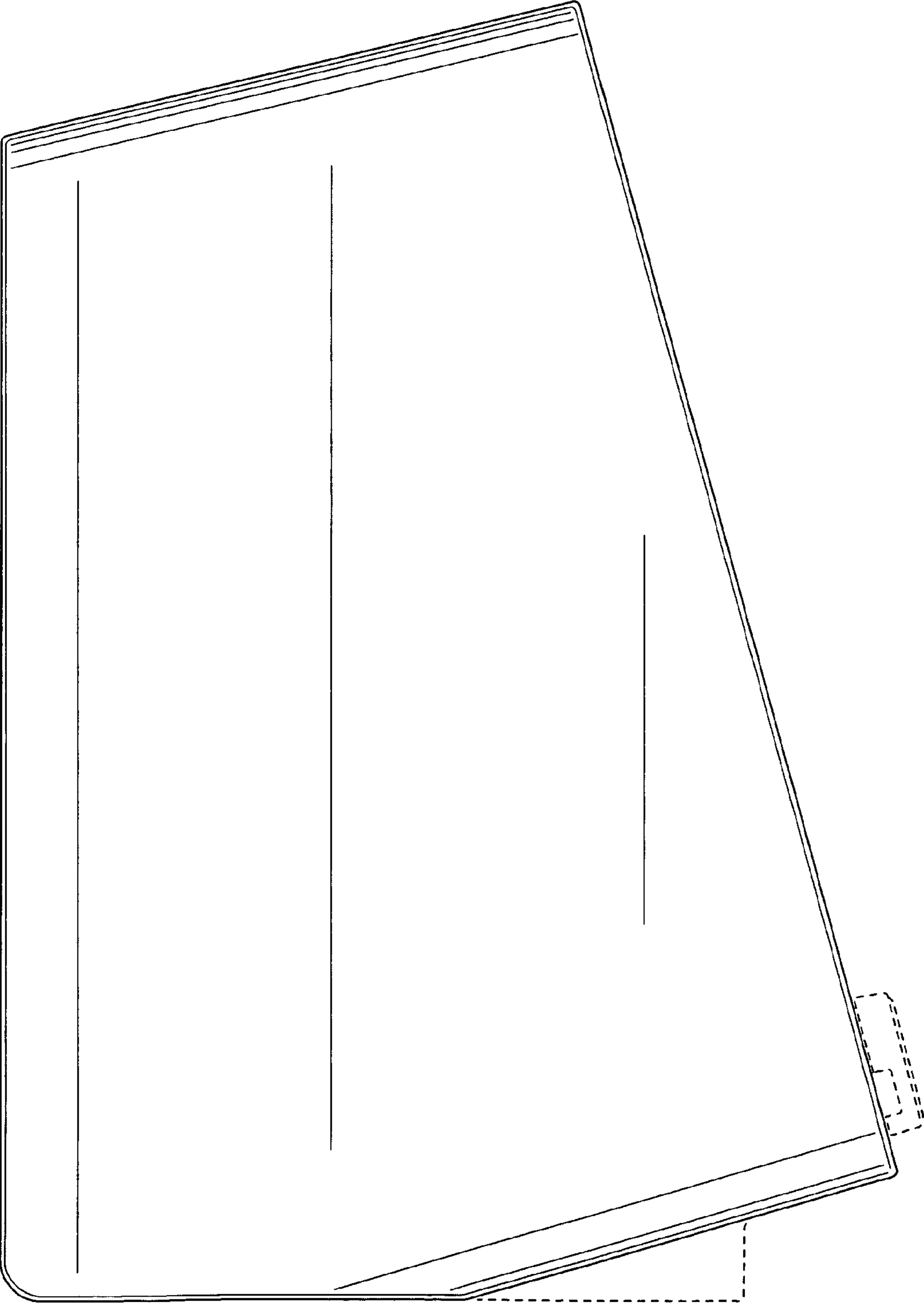

FIG.5

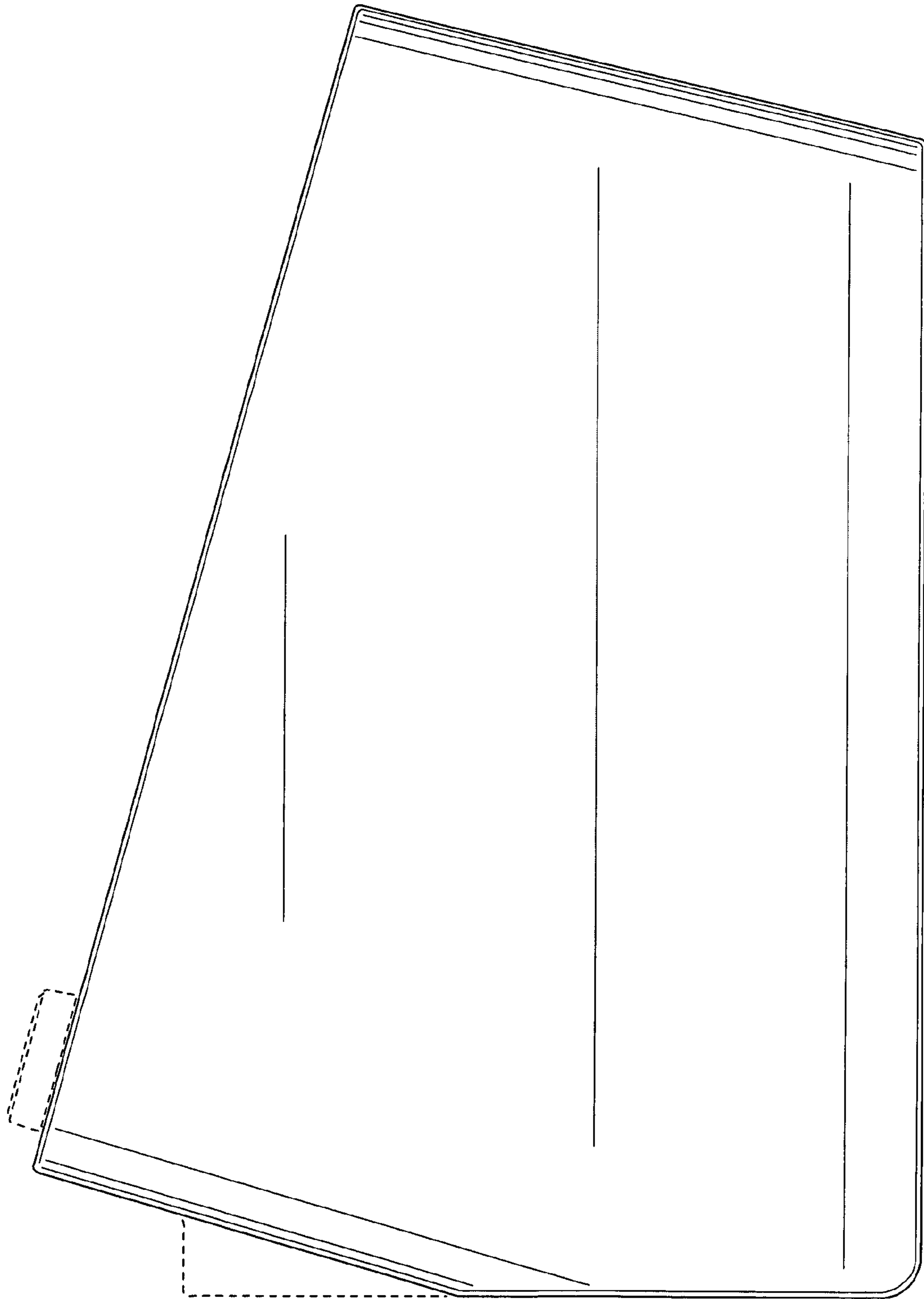

FIG.6

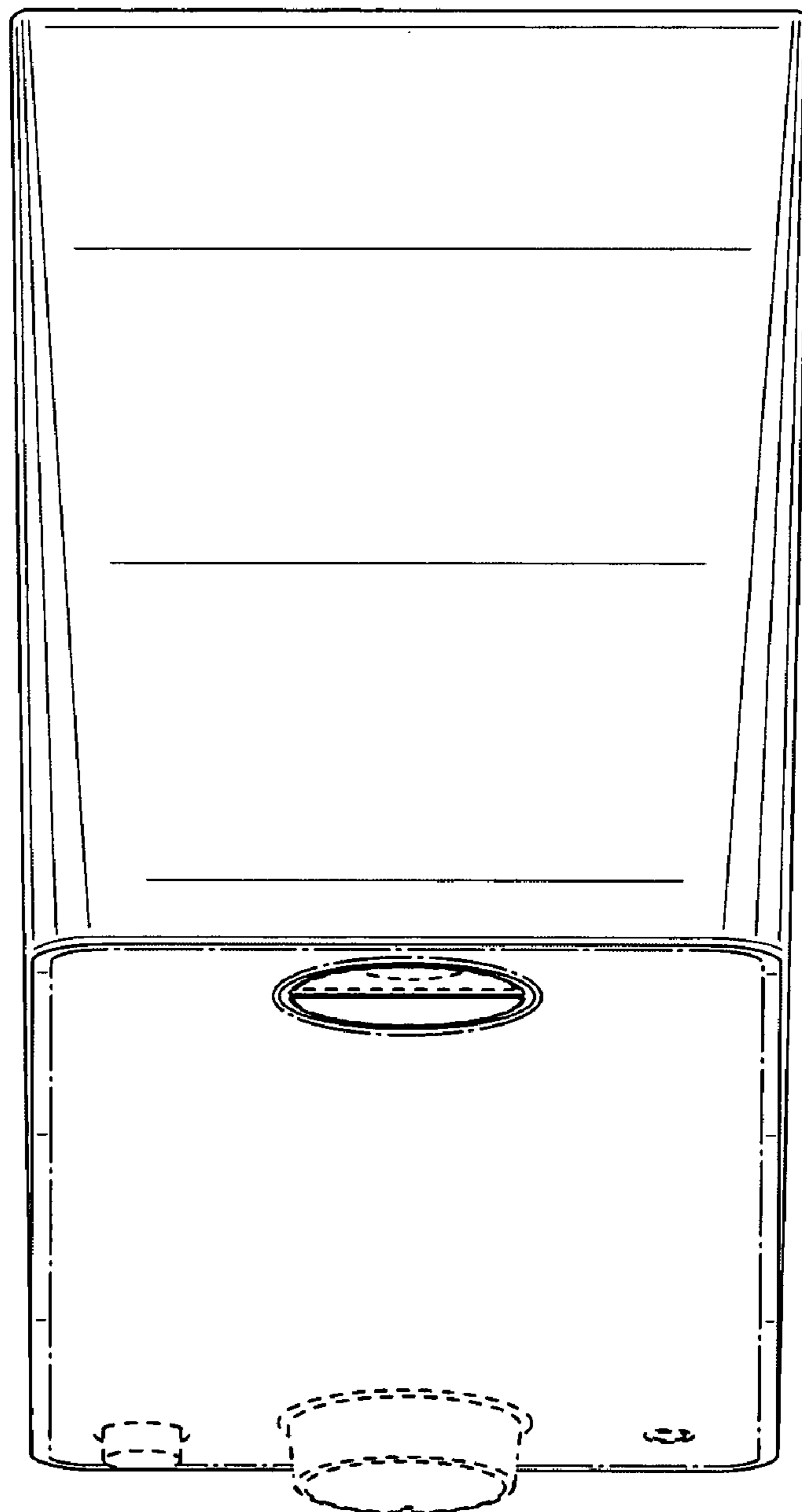

FIG.7

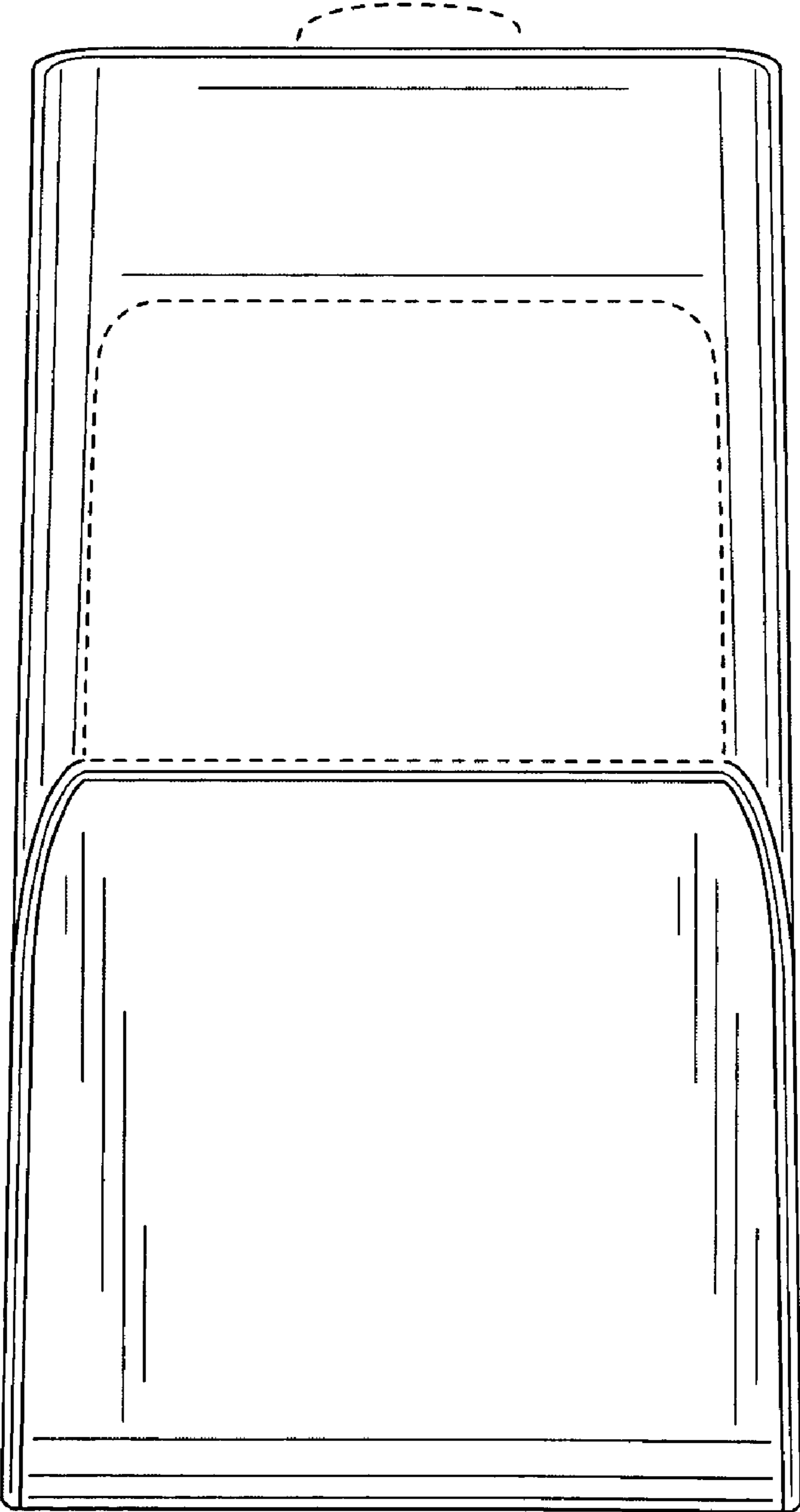



FIG.8

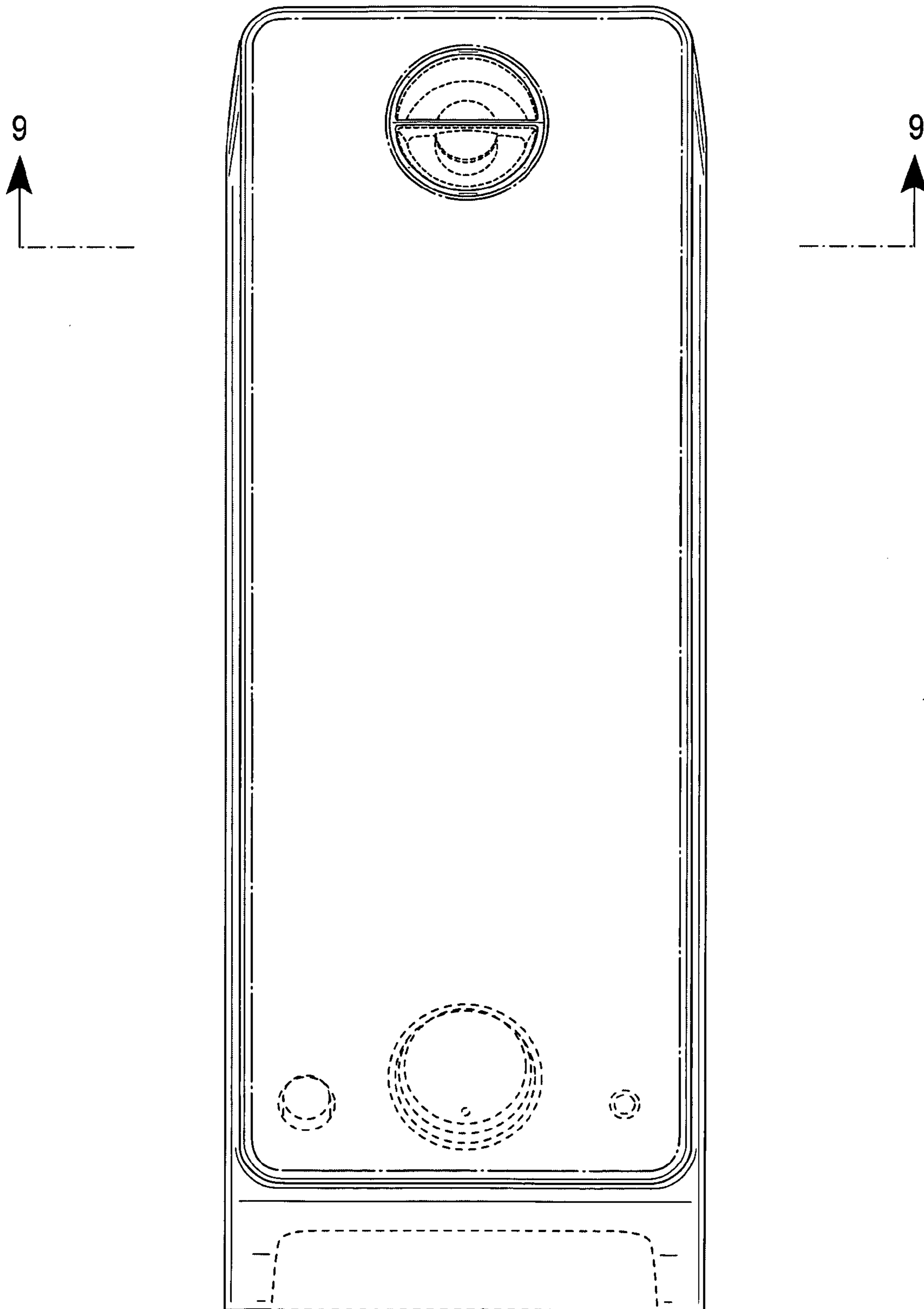

FIG.9

