



US00D600227S

(12) **United States Design Patent**
Ahn et al.

(10) **Patent No.:** **US D600,227 S**
(45) **Date of Patent:** **** Sep. 15, 2009**

(54) **COMMUNICATION DEVICE**

(75) Inventors: **Yoo Jung Ahn**, Chicago, IL (US); **Giles D. McWilliam**, Chicago, IL (US)

(73) Assignee: **Motorola Inc.**, Schaumburg, IL (US)

(**) Term: **14 Years**

(21) Appl. No.: **29/324,367**

(22) Filed: **Sep. 11, 2008**

(51) **LOC (9) Cl.** **14-03**

(52) **U.S. Cl.** **D14/138 AD**

(58) **Field of Classification Search** D14/138 R,
D14/138 AD, 138 AC, 138 C, 138 G, 191,
D14/203.1–203.8, 496, 138 AA, 138 AB,
D14/247–248, 137, 147, 218, 341–347; D10/65,
D10/78, 104; D13/168; D18/7; 455/566,
455/575.1, 575.3

See application file for complete search history.

(56) **References Cited**

U.S. PATENT DOCUMENTS

- D496,645 S * 9/2004 Yoo et al. D14/138 G
- D517,042 S * 3/2006 Byun et al. D14/191
- D525,609 S * 7/2006 Kim et al. D14/138 AB
- D528,094 S * 9/2006 Hwang D14/138 AD
- D528,096 S * 9/2006 Park D14/138 AD
- D549,204 S * 8/2007 Cho D14/138 AD
- D549,205 S * 8/2007 Cho D14/138 AD
- D552,069 S * 10/2007 Lee et al. D14/138 AD
- D560,188 S * 1/2008 Lee et al. D14/138 AD
- D561,148 S * 2/2008 Chen et al. D14/138 AD
- D561,155 S * 2/2008 Kim et al. D14/138 AD
- D561,783 S * 2/2008 Schmelling D14/496
- D563,353 S * 3/2008 Lee et al. D14/138 AD
- D572,229 S * 7/2008 Kim et al. D14/138 AD
- D572,699 S * 7/2008 Ahn et al. D14/138 G
- D576,140 S * 9/2008 Park et al. D14/138 AD
- D576,141 S * 9/2008 Moon et al. D14/138 G
- D576,144 S * 9/2008 Han et al. D14/138 AD
- D577,349 S * 9/2008 Choi et al. D14/138 AD
- D579,439 S * 10/2008 Chung et al. D14/138 R

- D579,897 S * 11/2008 Kim et al. D14/138 R
- D580,929 S * 11/2008 Kao et al. D14/346
- D583,340 S * 12/2008 Montin et al. D14/138 R
- D583,344 S * 12/2008 Sohn et al. D14/138 AD
- 2008/0119248 A1 * 5/2008 Nissen et al. 455/575.4
- 2009/0082067 A1 * 3/2009 Song 455/566

OTHER PUBLICATIONS

Motorola ZN300, announced Mar. 2009, [online], [retrieved on Mar. 6, 2009]. Retrieved from Internet, <URL: <http://www.gsmarena.com>>.*
 BenQ EL71 and/or BenQ-Siemens EL71, both announced Feb. 2006, [online], [retrieved on Dec. 13, 2007 and Feb. 16, 2007 respectively]. Retrieved from Internet, <URL: <http://www.gsmarena.com>>.*
 LG KC550, announced May 2008, [online], [retrieved on May 30, 2008]. Retrieved from Internet, <URL: <http://www.gsmarena.com>>.*
 NEC N500, announced 4th quarter 2004, [online], [retrieved on Feb. 20, 2007]. Retrieved from Internet, <URL: <http://www.gsmarena.com>>.*

* cited by examiner

Primary Examiner—Jeffrey D. Asch
Assistant Examiner—Bridget L Eland

(57) **CLAIM**

The ornamental design for a communication device, as shown and described.

DESCRIPTION

FIG. 1 is a perspective view of an ornamental design for a communication device;
 FIG. 2 is a front view thereof;
 FIG. 3 is a rear view thereof;
 FIG. 4 is a first side view thereof;
 FIG. 5 is a second side view thereof;
 FIG. 6 is a top view thereof; and,
 FIG. 7 is a bottom view thereof.

The broken lines immediately adjacent the shaded areas represent the bounds of the claimed design while all other broken lines are directed to environment and are for illustrative purposes only; the broken lines form no part of the claimed design.

1 Claim, 5 Drawing Sheets

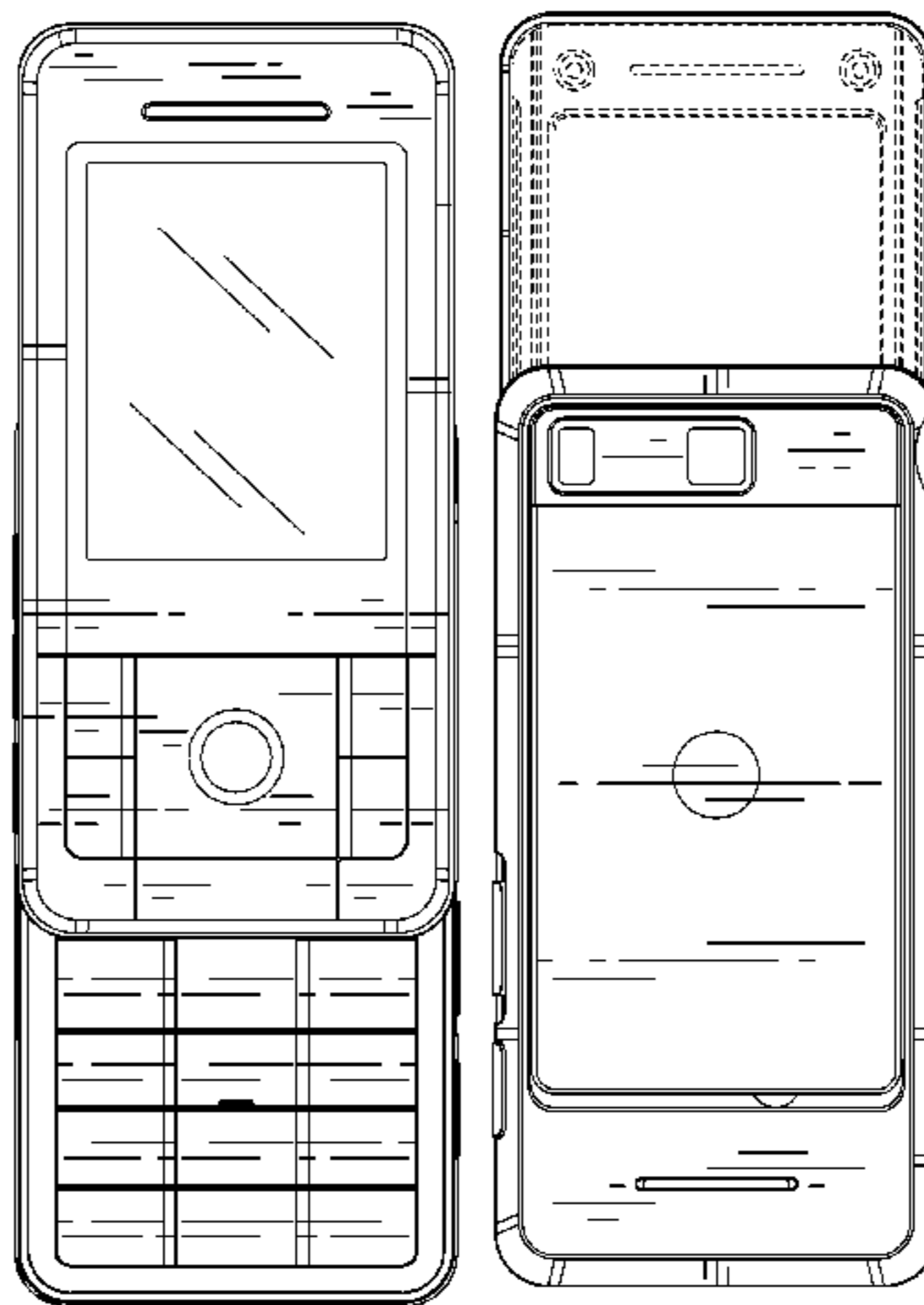

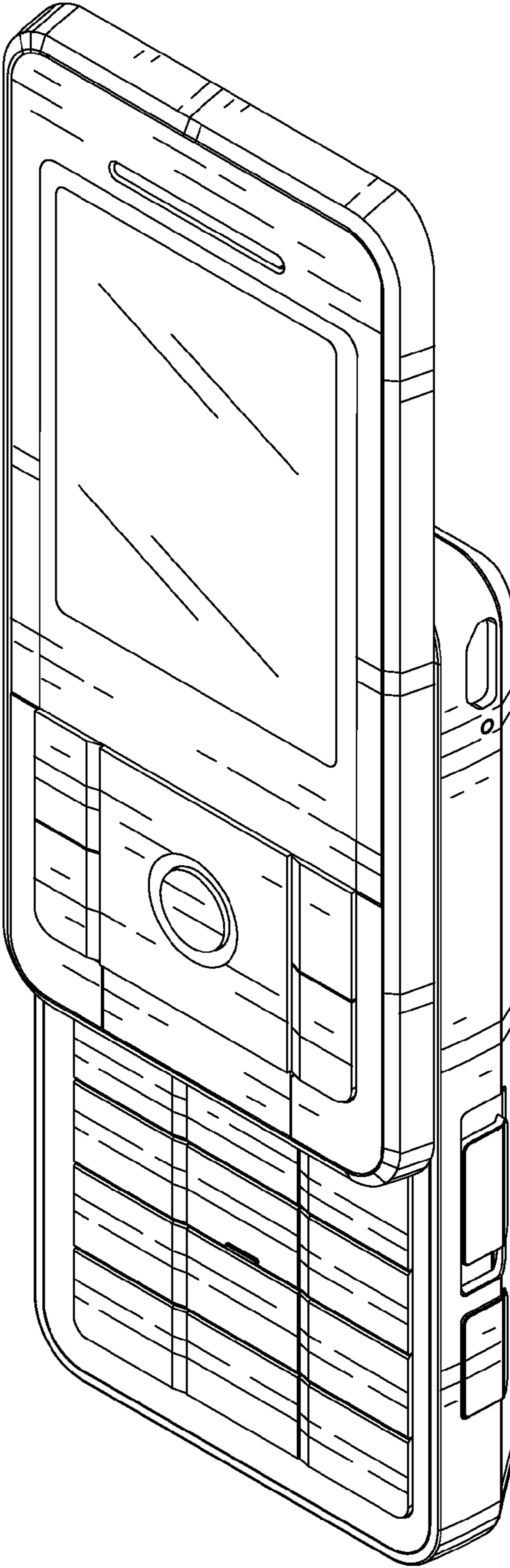

FIG. 1

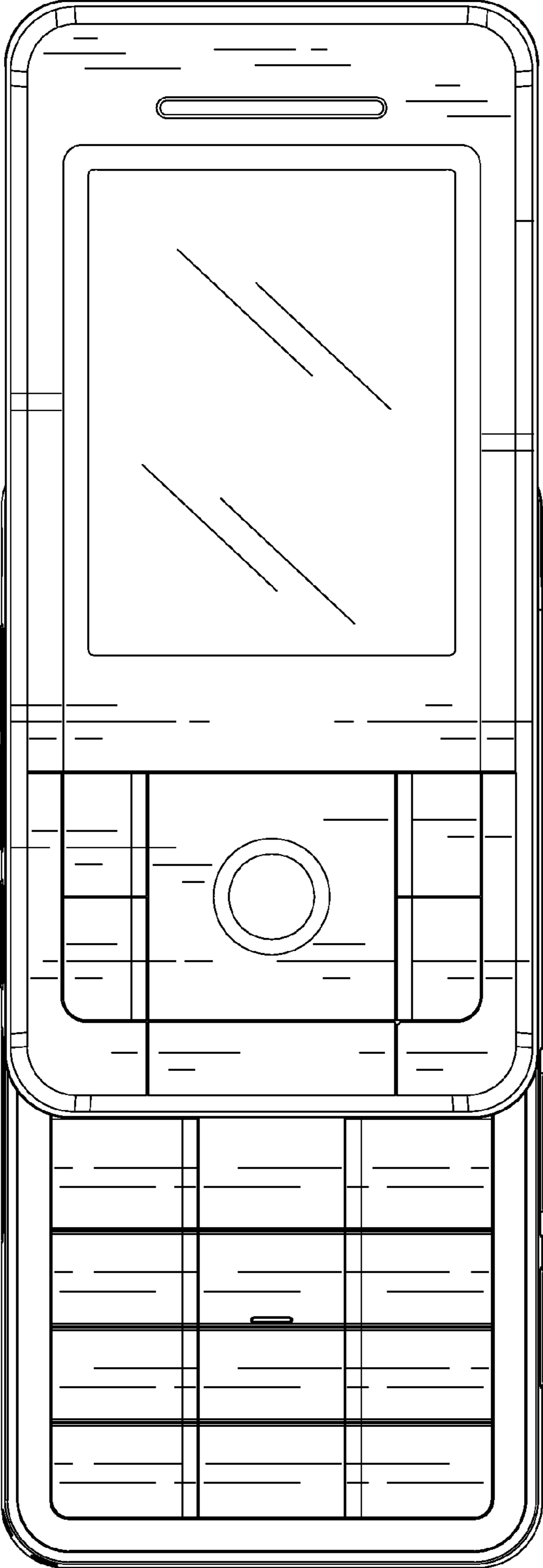

FIG. 2

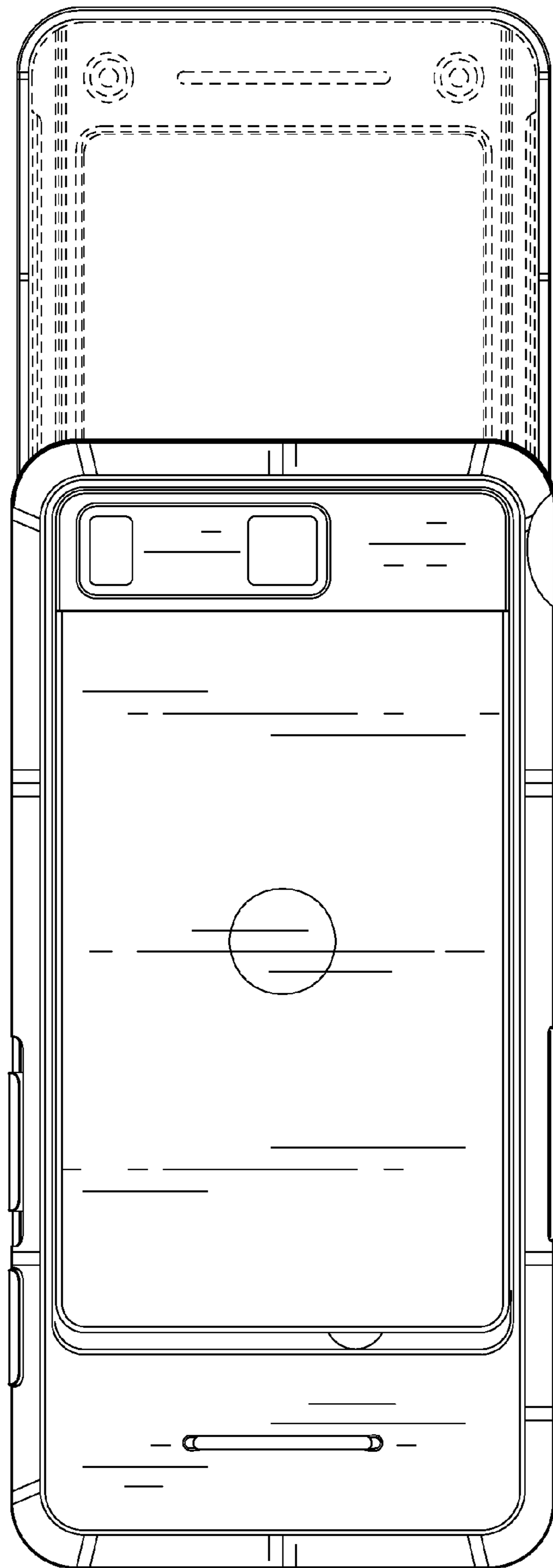

FIG. 3

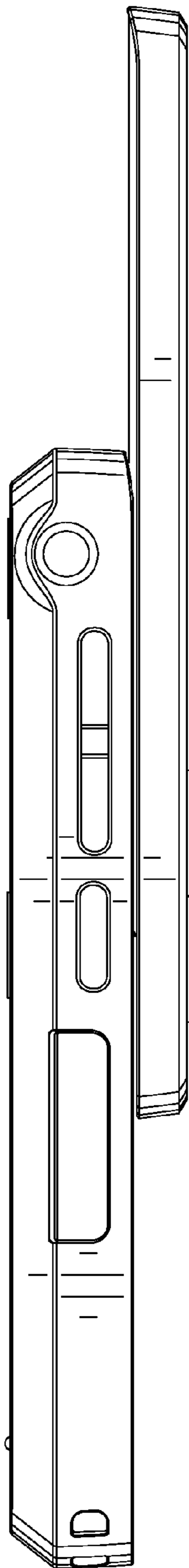

FIG. 4

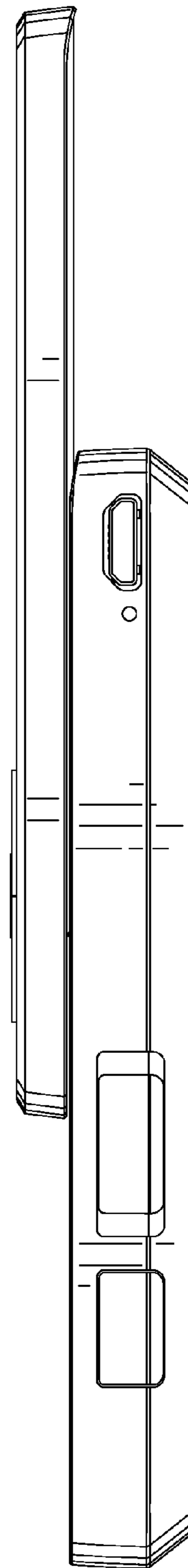

FIG. 5

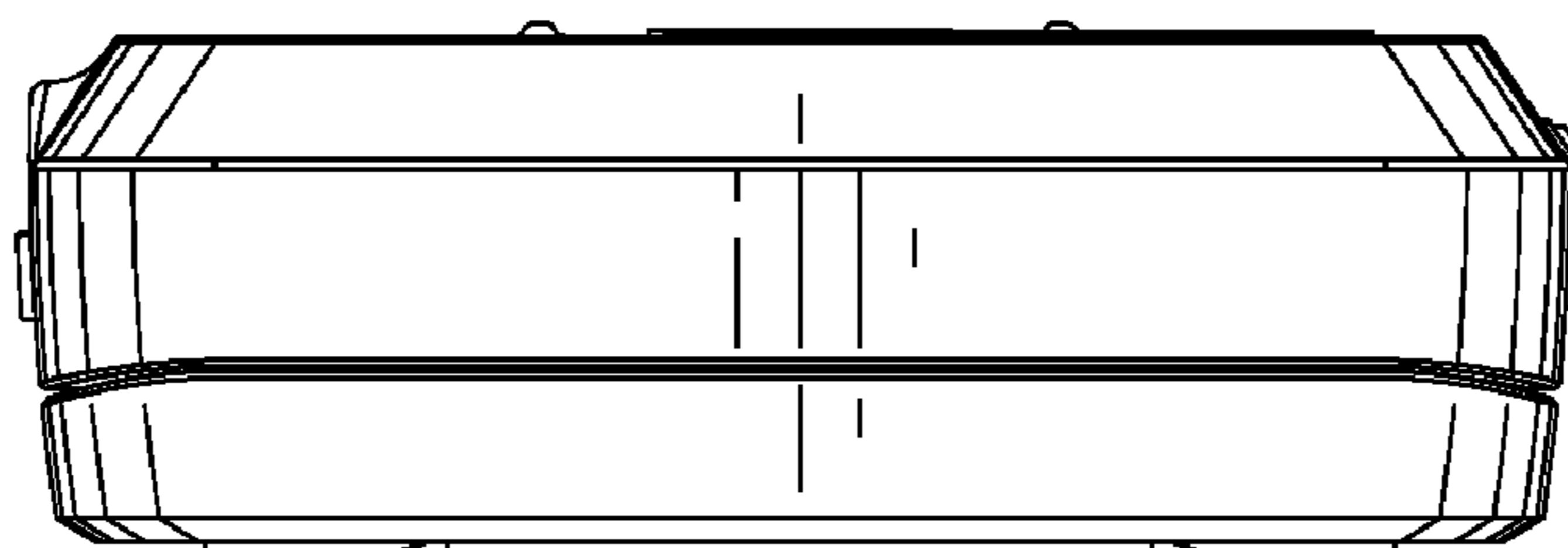

FIG. 6

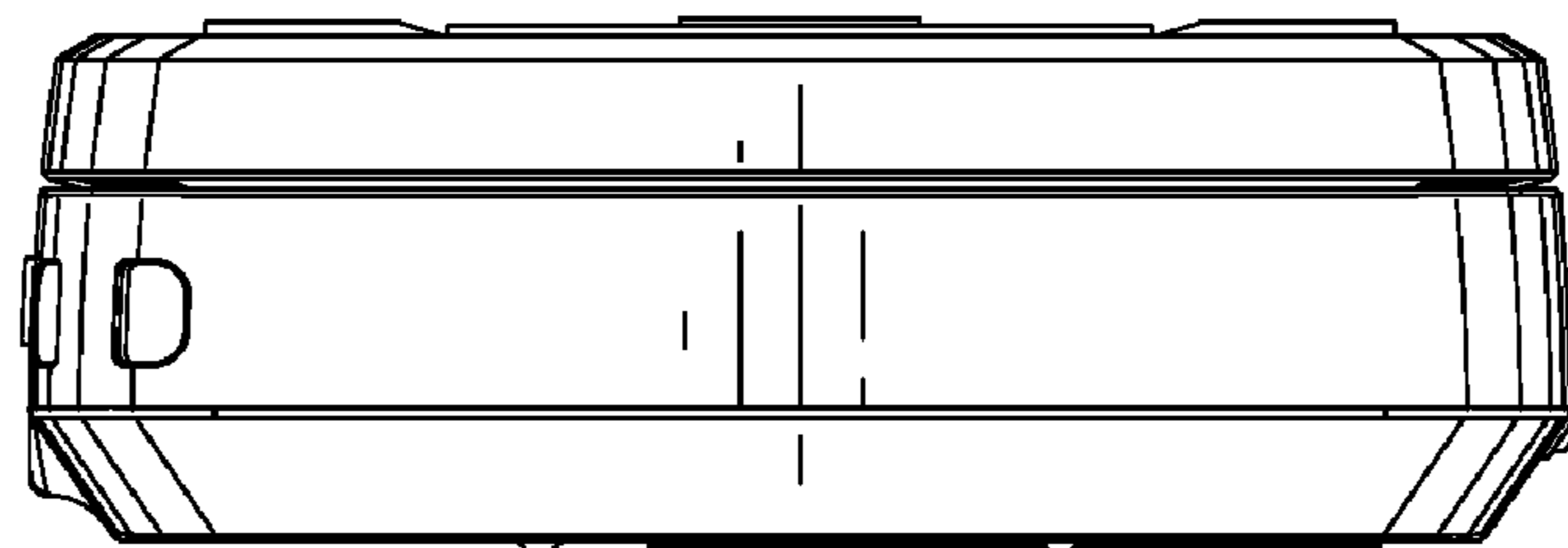

FIG. 7