



US00D600168S

(12) **United States Design Patent**  
**Quinn**

(10) **Patent No.:** **US D600,168 S**

(45) **Date of Patent:** **\*\* Sep. 15, 2009**

(54) **STROLLER WITH BASEBALL CAP SHAPED CANOPY**

(75) Inventor: **Robert A. Quinn**, Tulare, CA (US)

(73) Assignee: **DonaCorp**, Tulare, CA (US)

(\*\*) Term: **14 Years**

(21) Appl. No.: **29/327,683**

(22) Filed: **Nov. 11, 2008**

(51) **LOC (9) Cl.** ..... **12-12**

(52) **U.S. Cl.** ..... **D12/129; D21/427**

(58) **Field of Classification Search** ..... D12/128-133;  
D21/433; D34/12, 27, 30; 280/62, 647-650,  
280/29, 200, 47.38, 250.1, 259, 642, 658;  
296/65.03, 65.04; 297/DIG. 4; 135/65-67,  
135/74; D2/873, 876

See application file for complete search history.

(56) **References Cited**

**U.S. PATENT DOCUMENTS**

- D360,519 S \* 7/1995 Bailey ..... D2/876
- D388,748 S \* 1/1998 Jackson ..... D12/129
- D400,129 S \* 10/1998 Udelhoven ..... D12/130
- D475,659 S \* 6/2003 Diaz ..... D12/129
- D482,185 S \* 11/2003 Park ..... D2/876

- D554,027 S \* 10/2007 Quinn ..... D12/129
- D554,028 S \* 10/2007 Quinn ..... D12/129
- D556,097 S \* 11/2007 Quinn ..... D12/129
- D562,190 S \* 2/2008 Quinn ..... D12/129
- D571,691 S \* 6/2008 Quinn ..... D12/129

\* cited by examiner

*Primary Examiner*—Charles A Rademaker

*Assistant Examiner*—Charles D Hanson

(74) *Attorney, Agent, or Firm*—Blakely, Sokoloff, Taylor & Zafman, LLP

(57) **CLAIM**

The ornamental design of a stroller with baseball cap shaped canopy, as shown and described.

**DESCRIPTION**

FIG. 1 is a perspective view of a stroller with baseball cap shaped canopy showing my new design;

FIG. 2 is a top plan view thereof;

FIG. 3 is a bottom plan view thereof;

FIG. 4 is a left side view thereof;

FIG. 5 is a right side view thereof;

FIG. 6 is a front view thereof; and,

FIG. 7 is a rear view thereof.

**1 Claim, 6 Drawing Sheets**

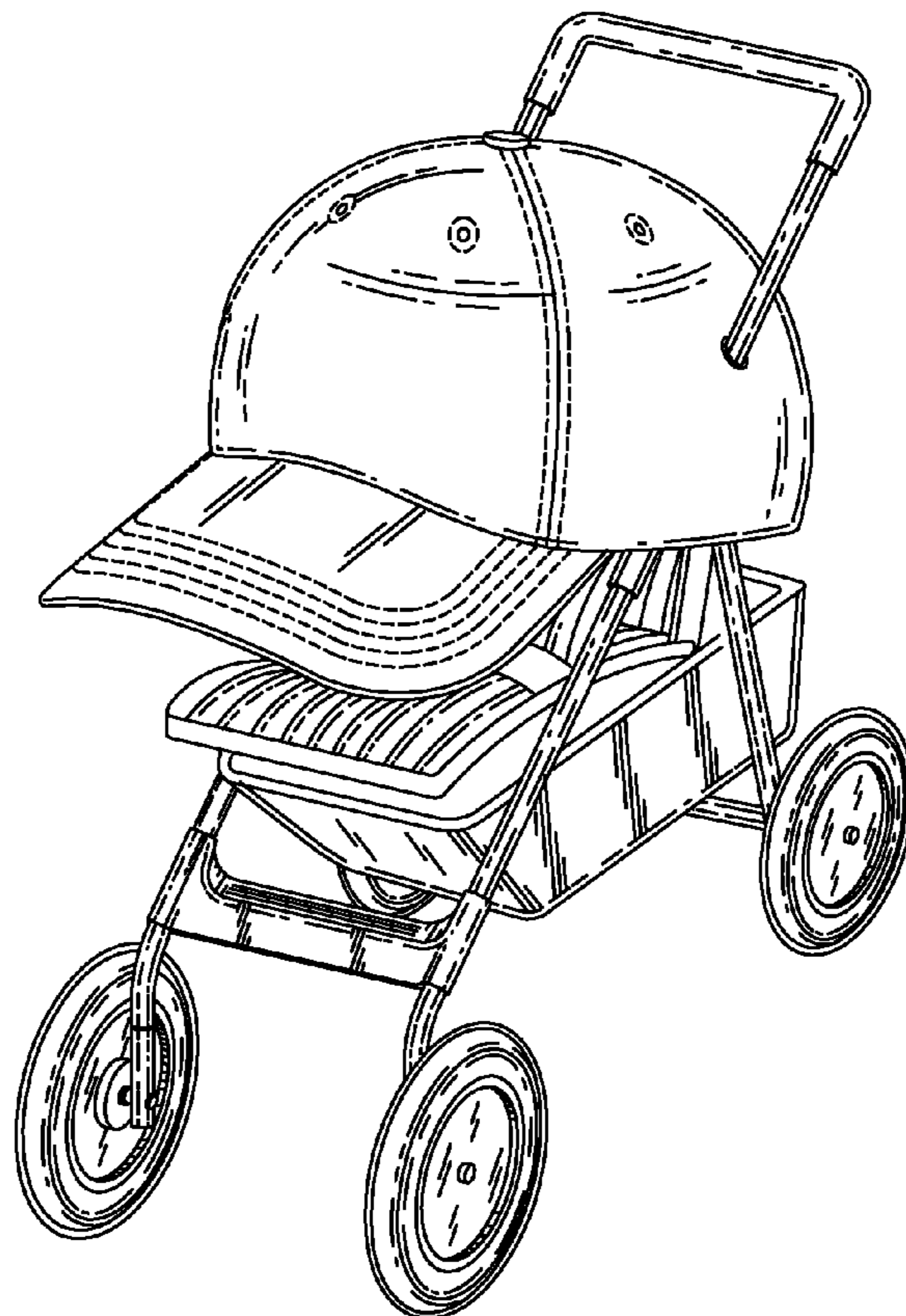

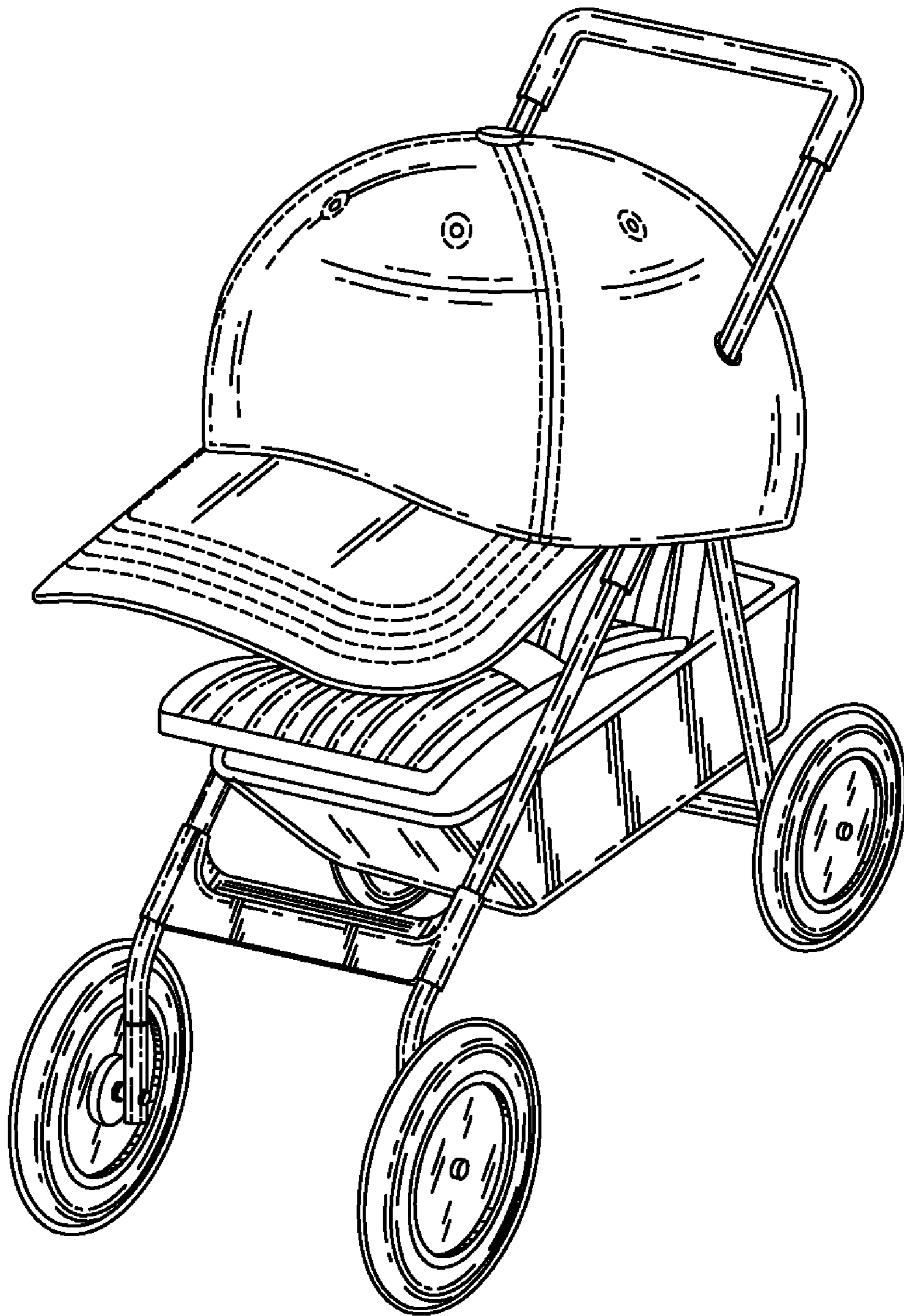

**FIG. 1**

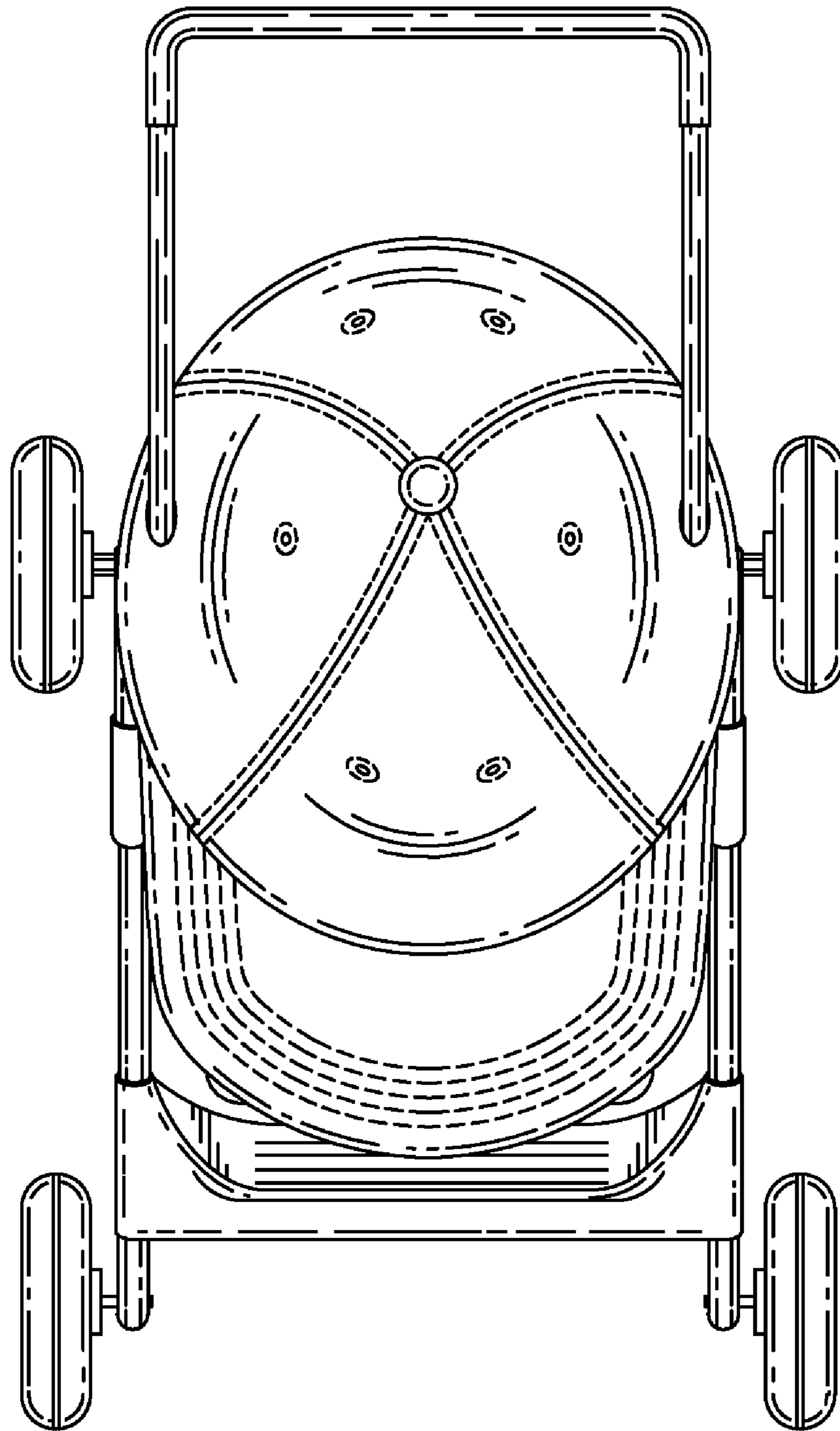
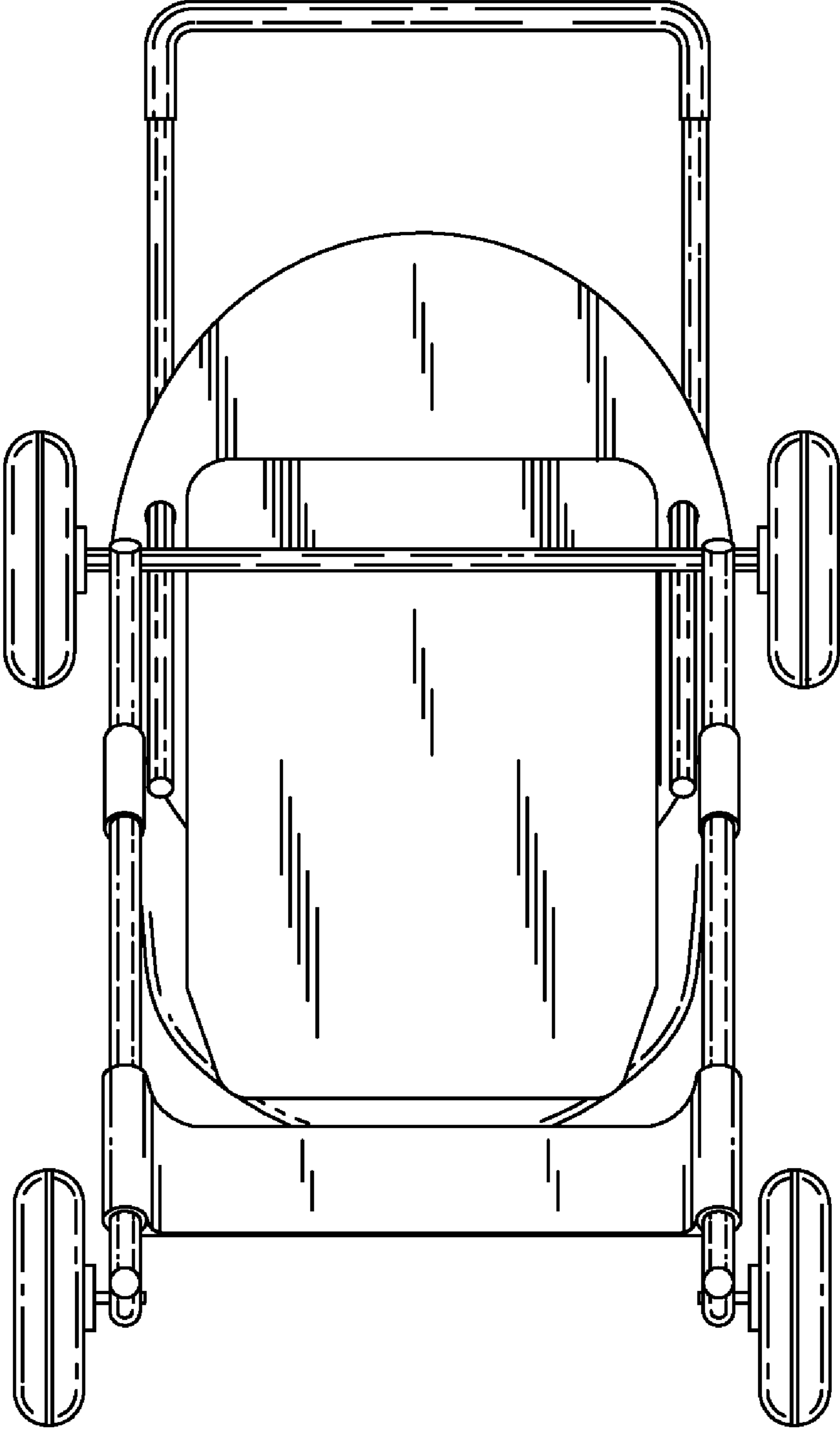
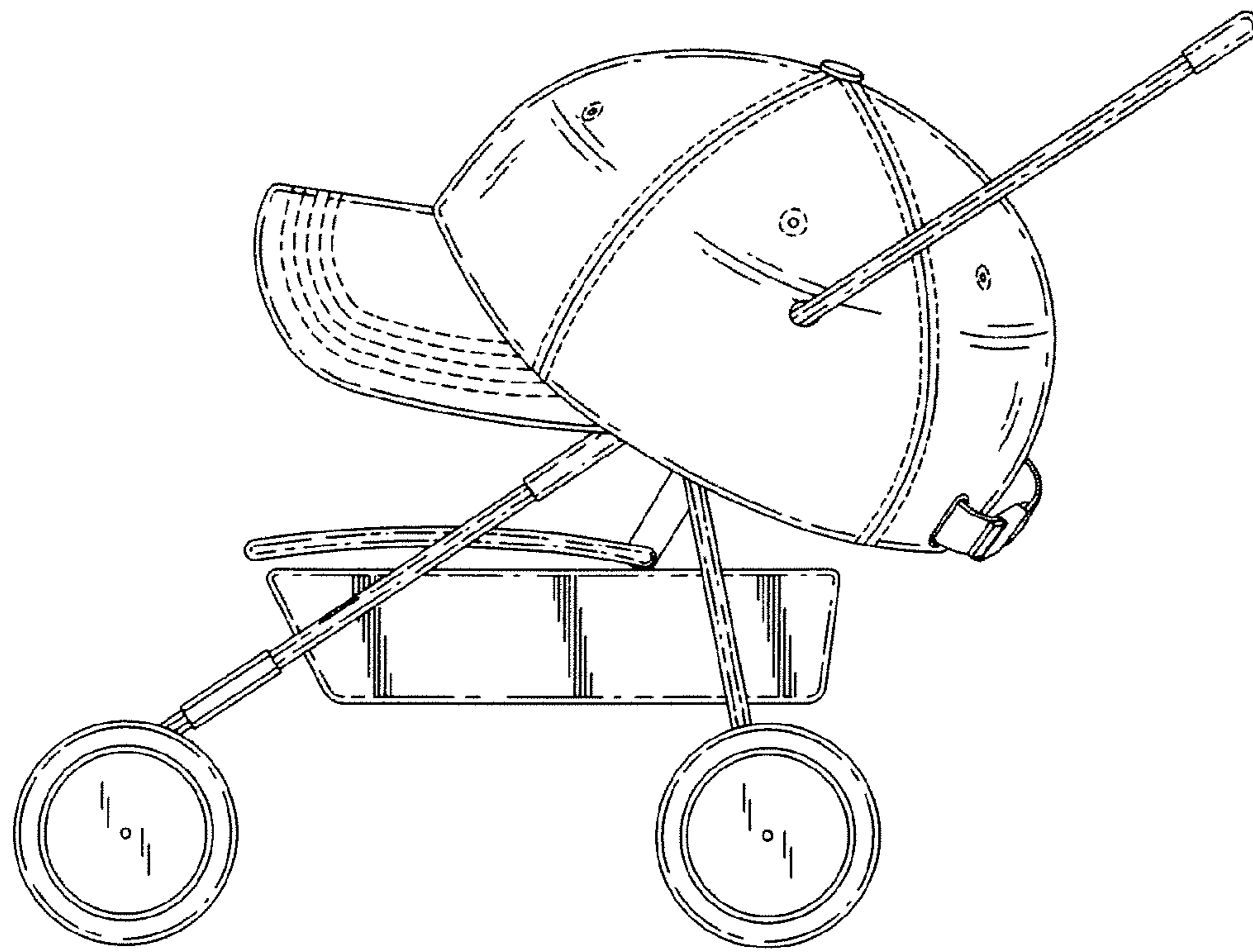

FIG. 2



*FIG. 3*



*FIG. 4*

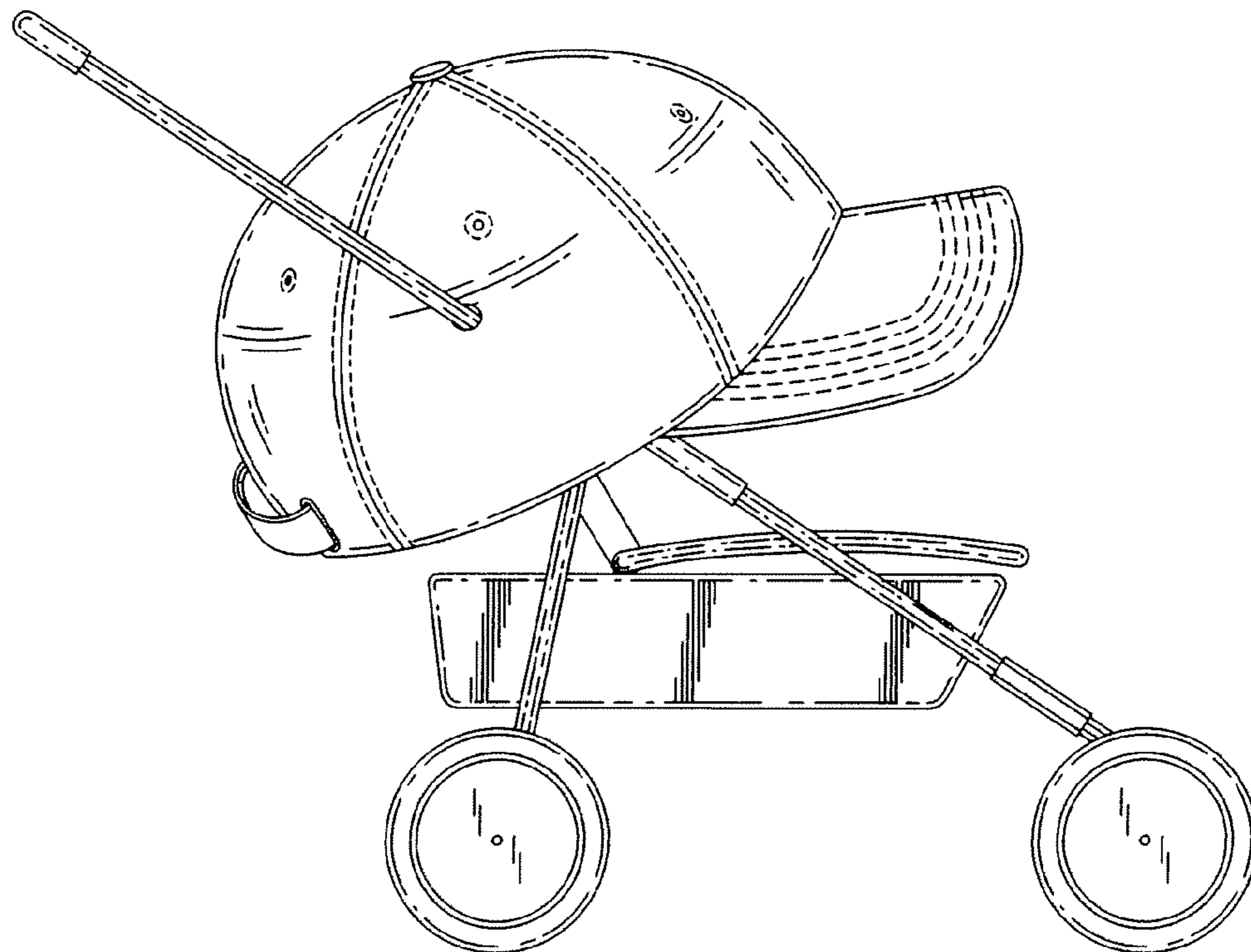

*FIG. 5*

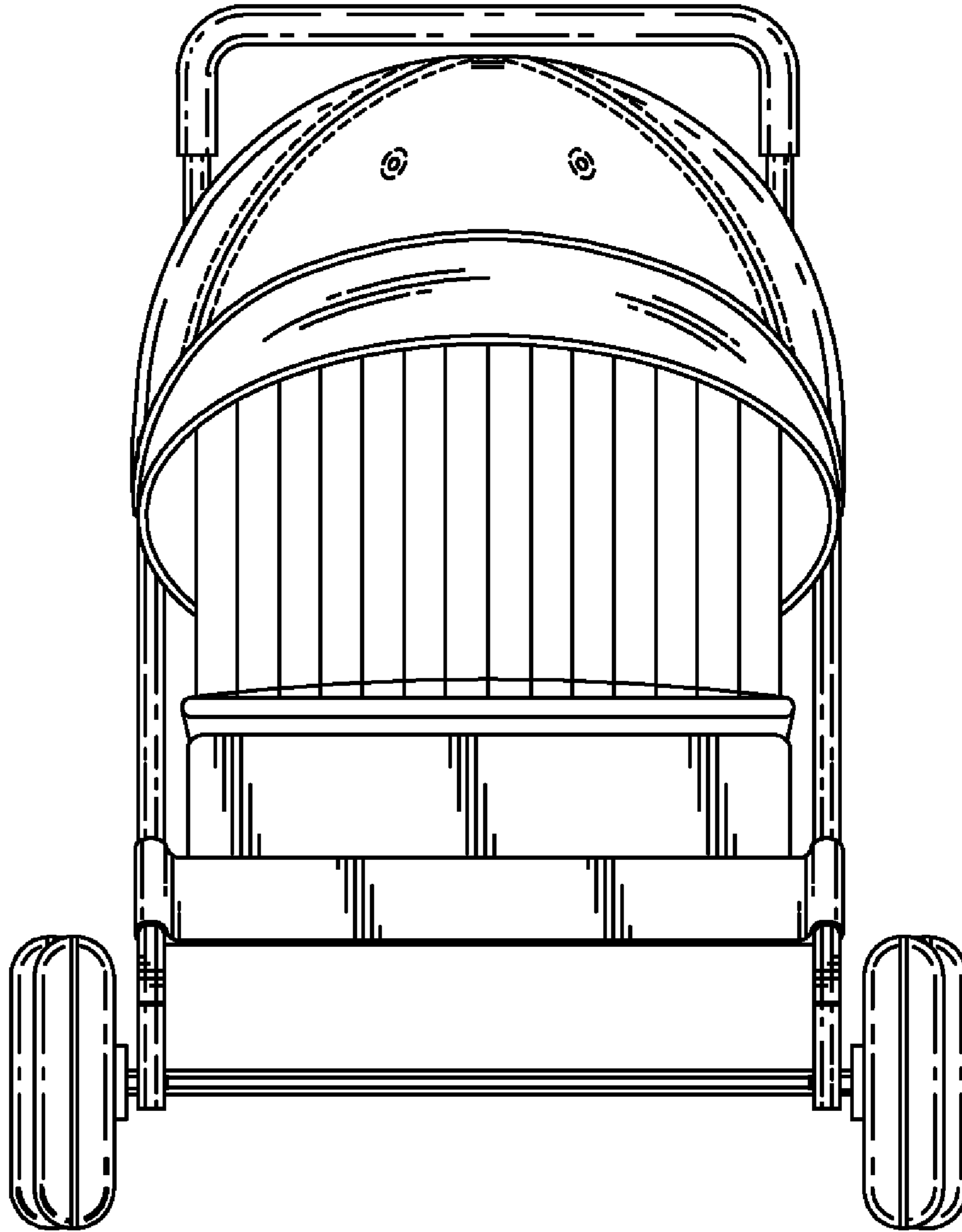

*FIG. 6*

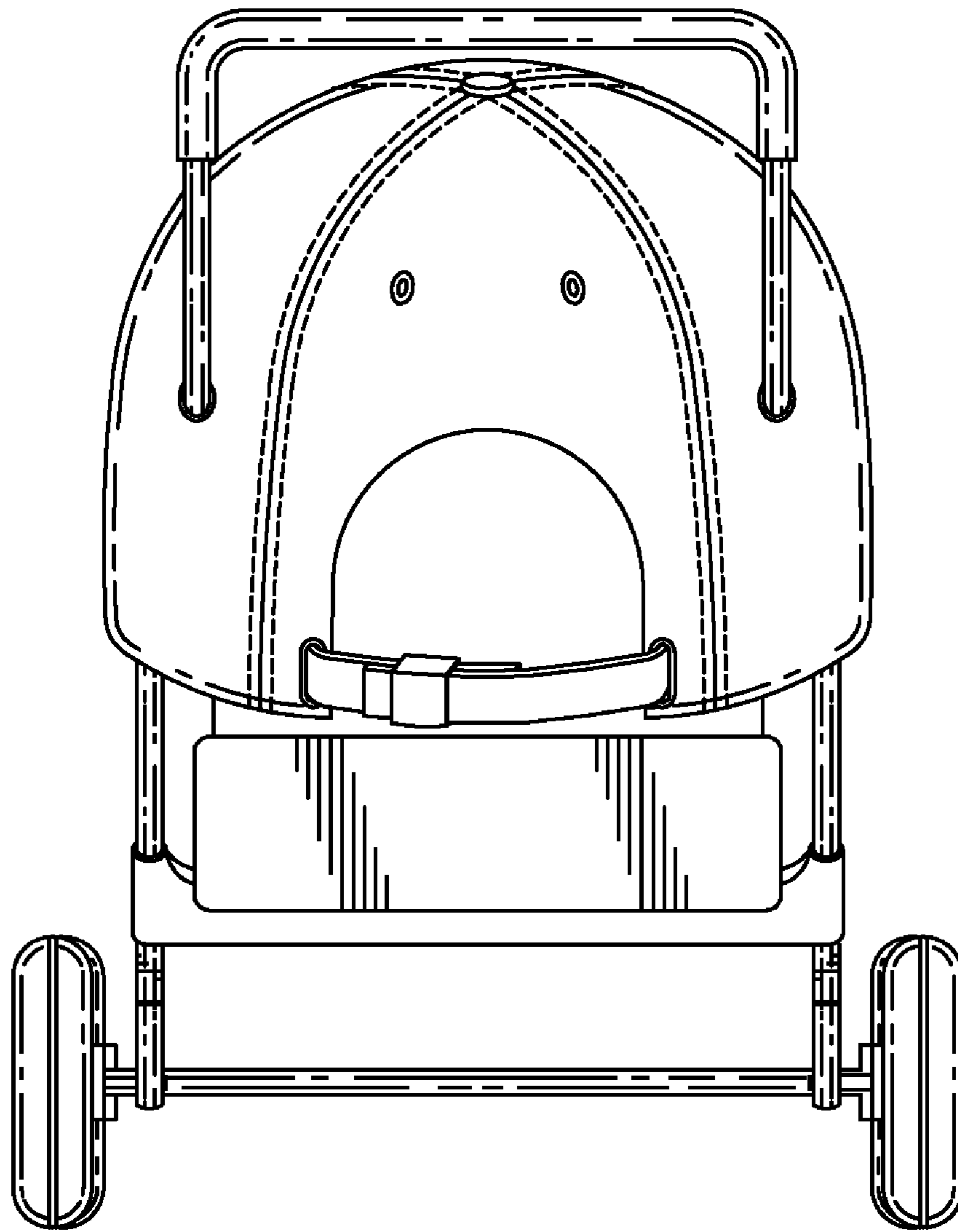

*FIG. 7*