



US00D600165S

(12) **United States Design Patent**
Tashiro

(10) **Patent No.:** **US D600,165 S**
(45) **Date of Patent:** **** Sep. 15, 2009**

(54) **PAIR OF FOOT BOARDS FOR
FOUR-WHEELED MOTORCYCLE**

D515,978 S * 2/2006 Luh D12/107
D516,960 S * 3/2006 Luh D12/107

* cited by examiner

(75) Inventor: **Yasuho Tashiro**, Tokyo-to (JP)

Primary Examiner—Robin V Webster

(73) Assignee: **Yamaha Hatsudoki Kabushiki Kaisha**
(JP)

Assistant Examiner—Linda Brooks

(74) *Attorney, Agent, or Firm*—Ostrolenk Faber LLP

(**) Term: **14 Years**

(57) **CLAIM**

(21) Appl. No.: **29/319,219**

The ornamental design for a pair of foot boards for four-wheeled motorcycle, as shown and described.

(22) Filed: **Jun. 5, 2008**

DESCRIPTION

(51) **LOC (9) Cl.** **12-11**

(52) **U.S. Cl.** **D12/114; D12/107**

(58) **Field of Classification Search** D12/3,
D12/86, 87, 107, 110, 181–186, 203, 114,
D12/122, 125; 180/225, 229, 223, 233, 311,
180/315, 90.6; 74/478, 478.5, 473.16; 296/77.1,
296/78.1, 198, 75; 280/152.1–152.3, 847–852,
280/770, 291, 163, 160.1

See application file for complete search history.

FIG. 1 is a front, left side, perspective view of a pair of foot boards for four-wheeled motorcycle showing my new design; FIG. 2 is a left side view thereof; FIG. 3 is a right side view thereof; FIG. 4 is a front view thereof; FIG. 5 is a rear view thereof; FIG. 6 is a top plan view thereof; and, FIG. 7 is a bottom view thereof.

(56) **References Cited**

U.S. PATENT DOCUMENTS

D389,440 S * 1/1998 Walters et al. D12/120
6,224,134 B1 * 5/2001 Johnson et al. 296/75
6,270,106 B1 * 8/2001 Maki et al. 280/291
6,502,863 B1 * 1/2003 Takahashi et al. 280/847
D512,001 S * 11/2005 Kato et al. D12/107

The left side foot board and right side foot board of the pair of foot boards for four-wheeled motorcycle are mirror images of each other.

The elements shown in broken lines form no part of the claimed design.

1 Claim, 4 Drawing Sheets

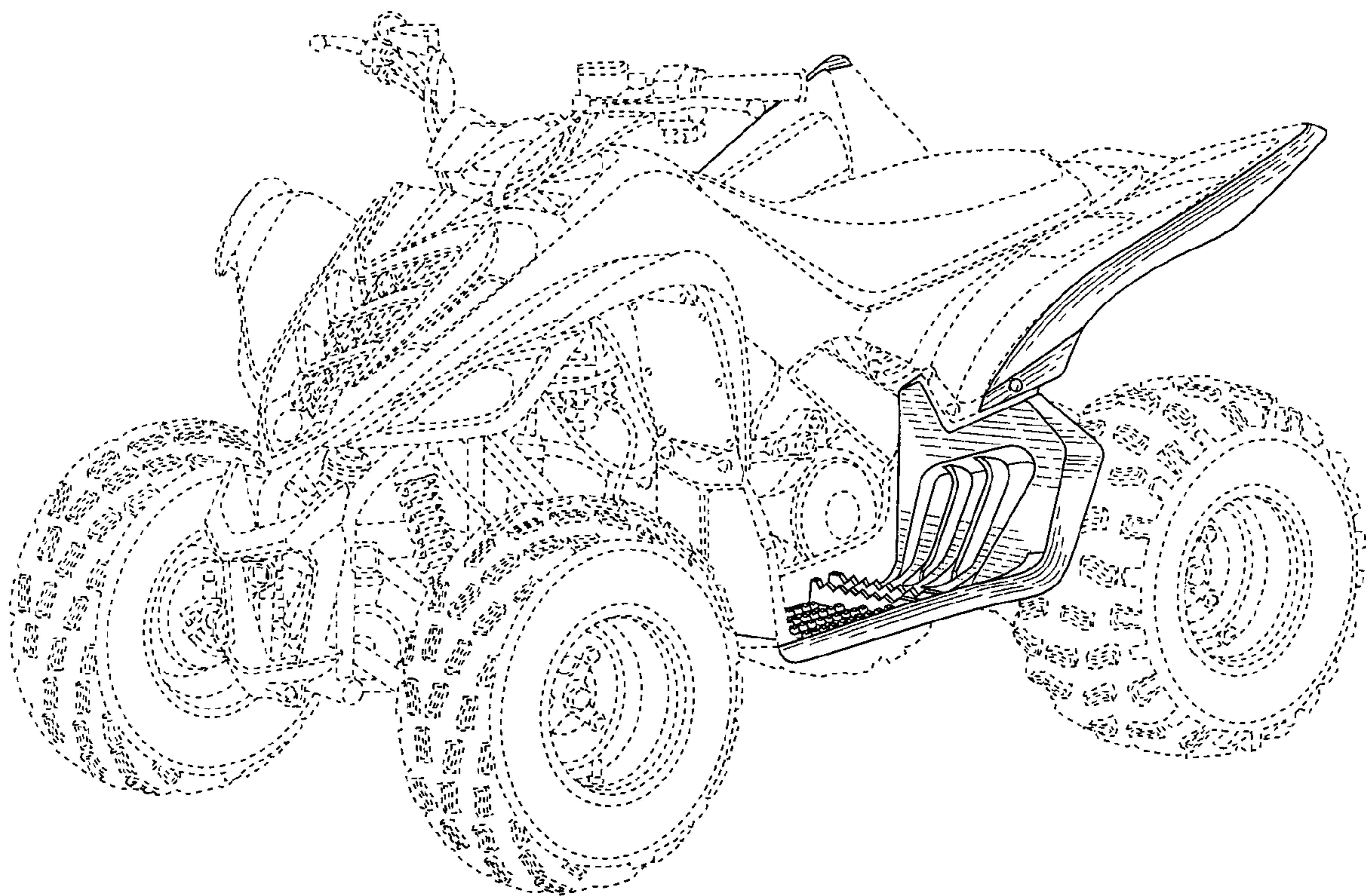

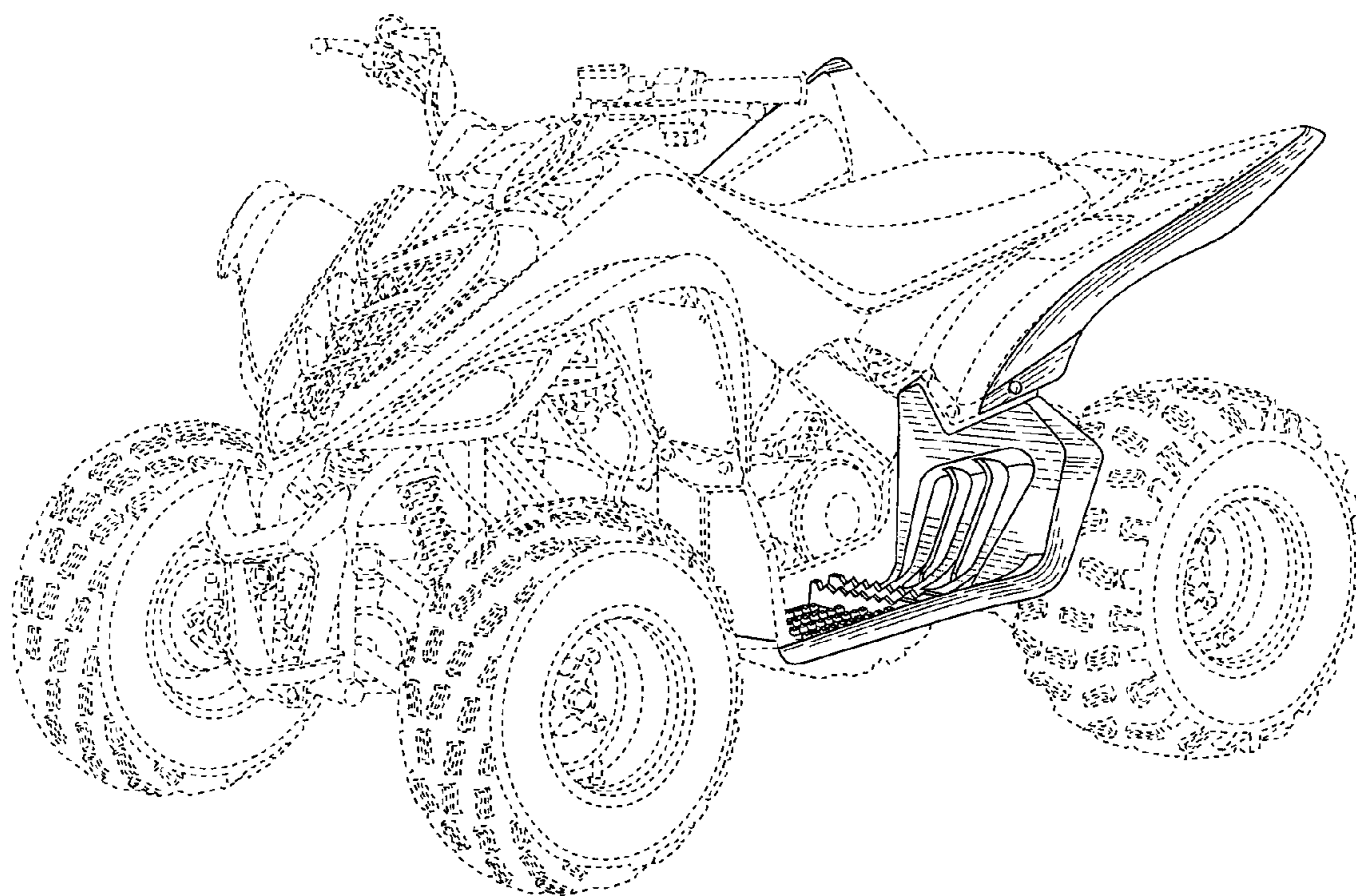

Fig. 1

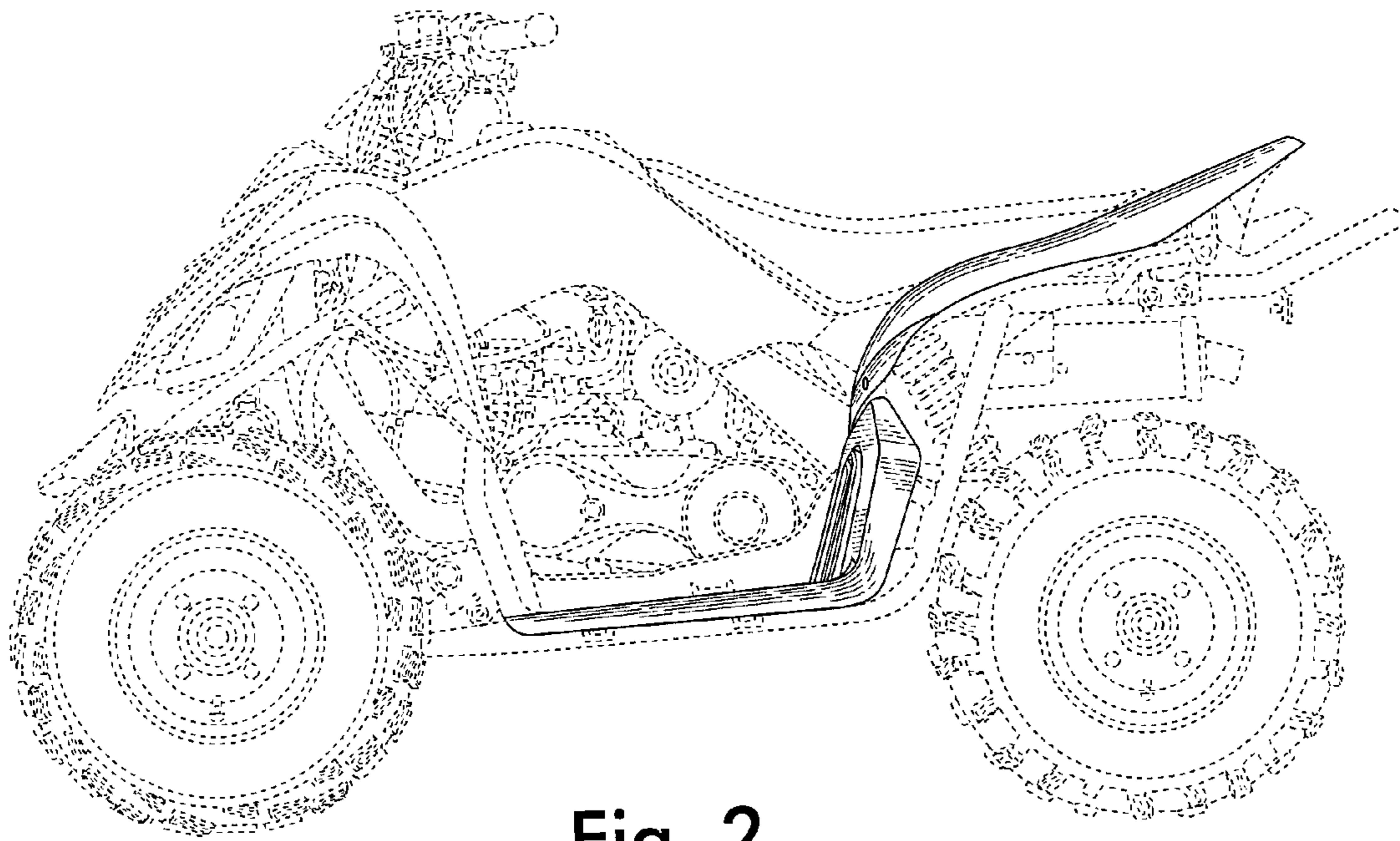

Fig. 2

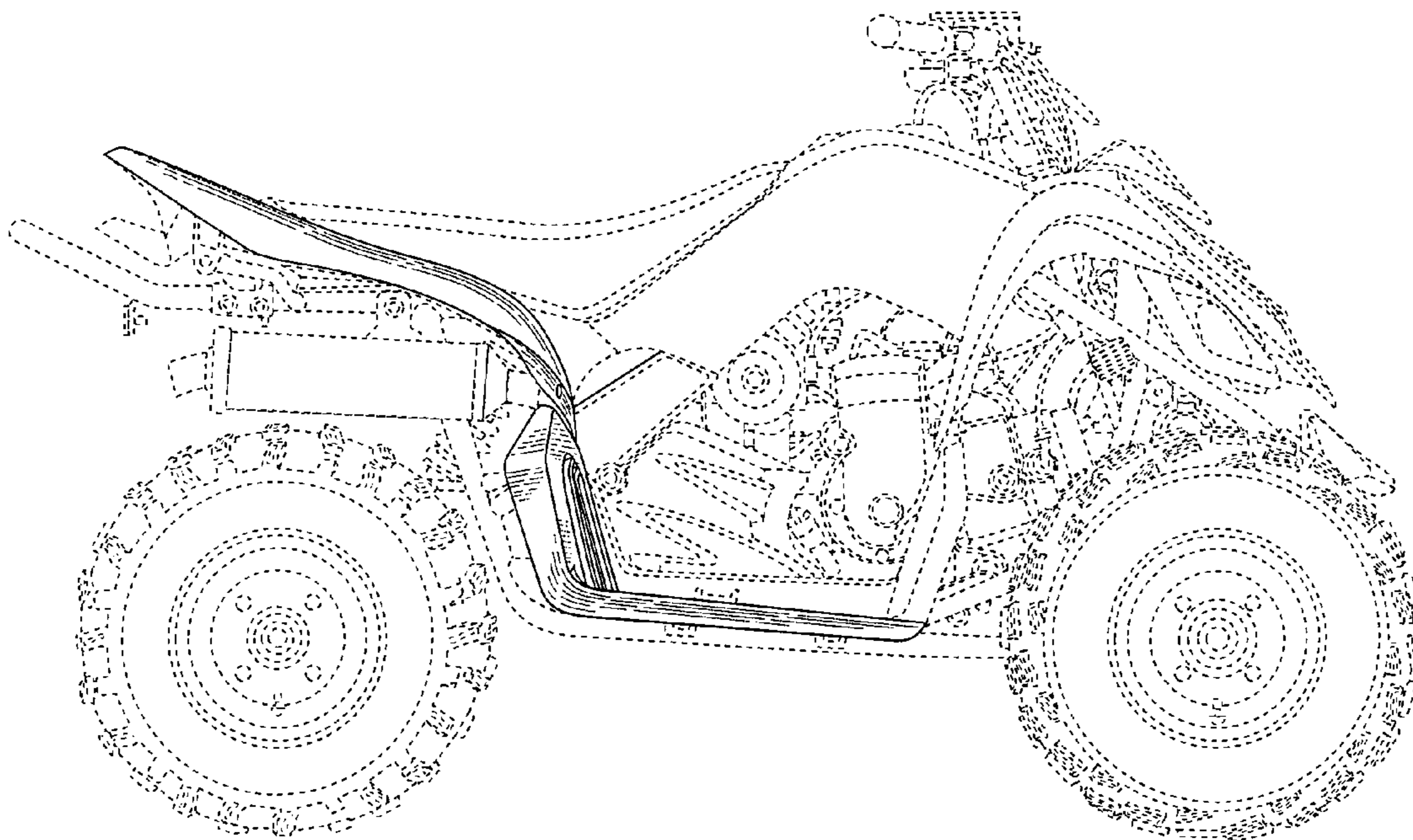

Fig. 3

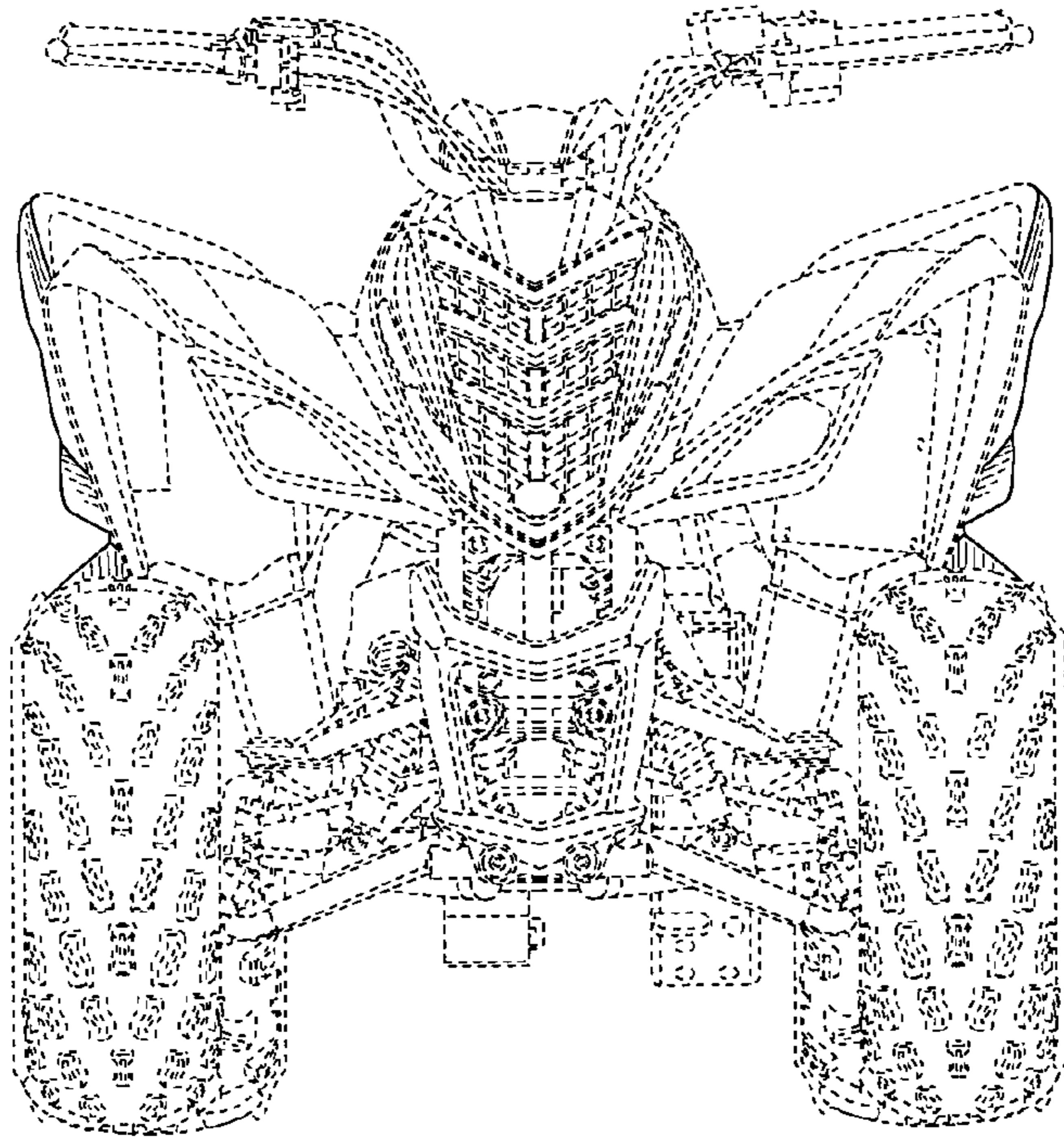

Fig. 4

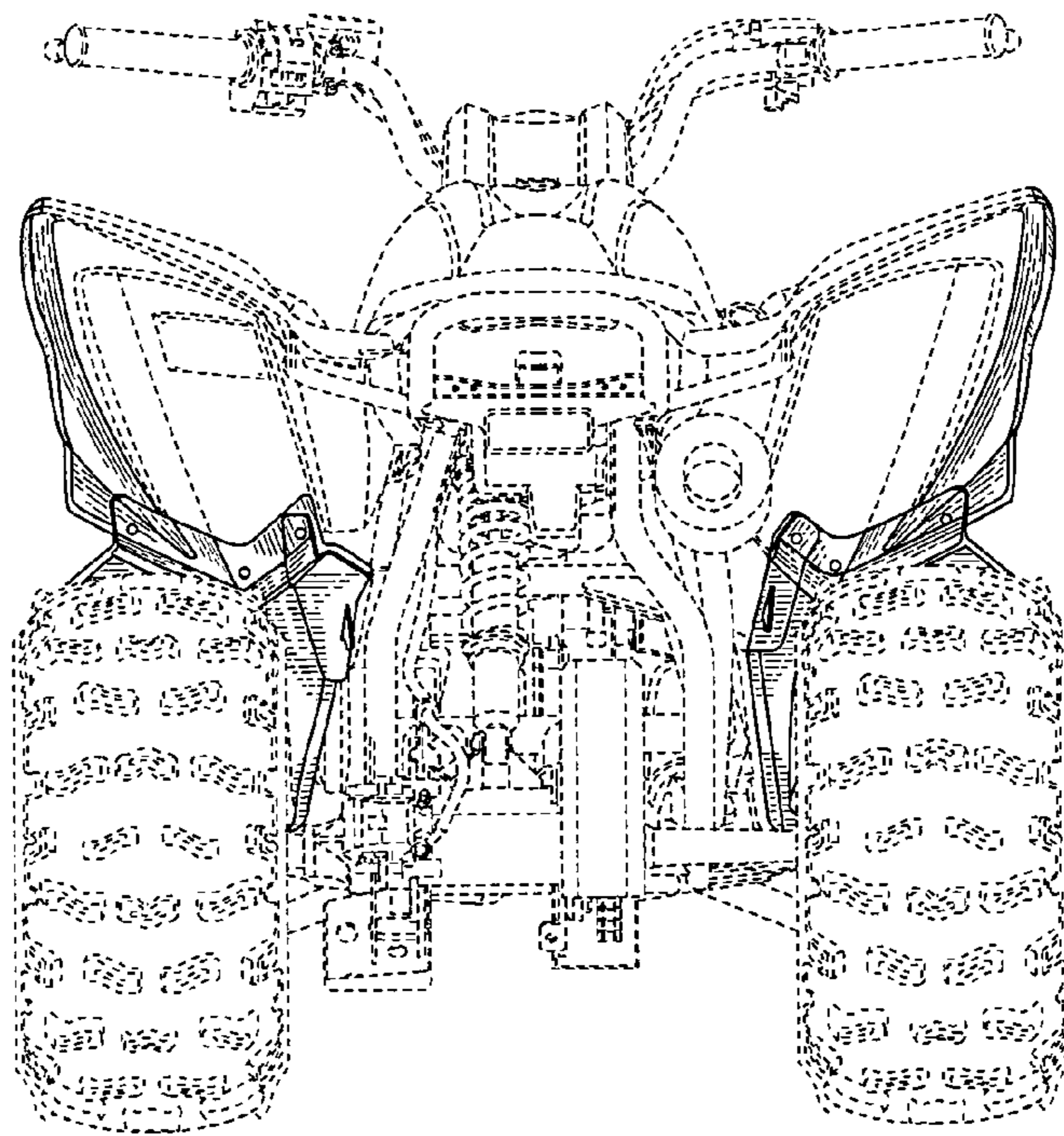

Fig. 5

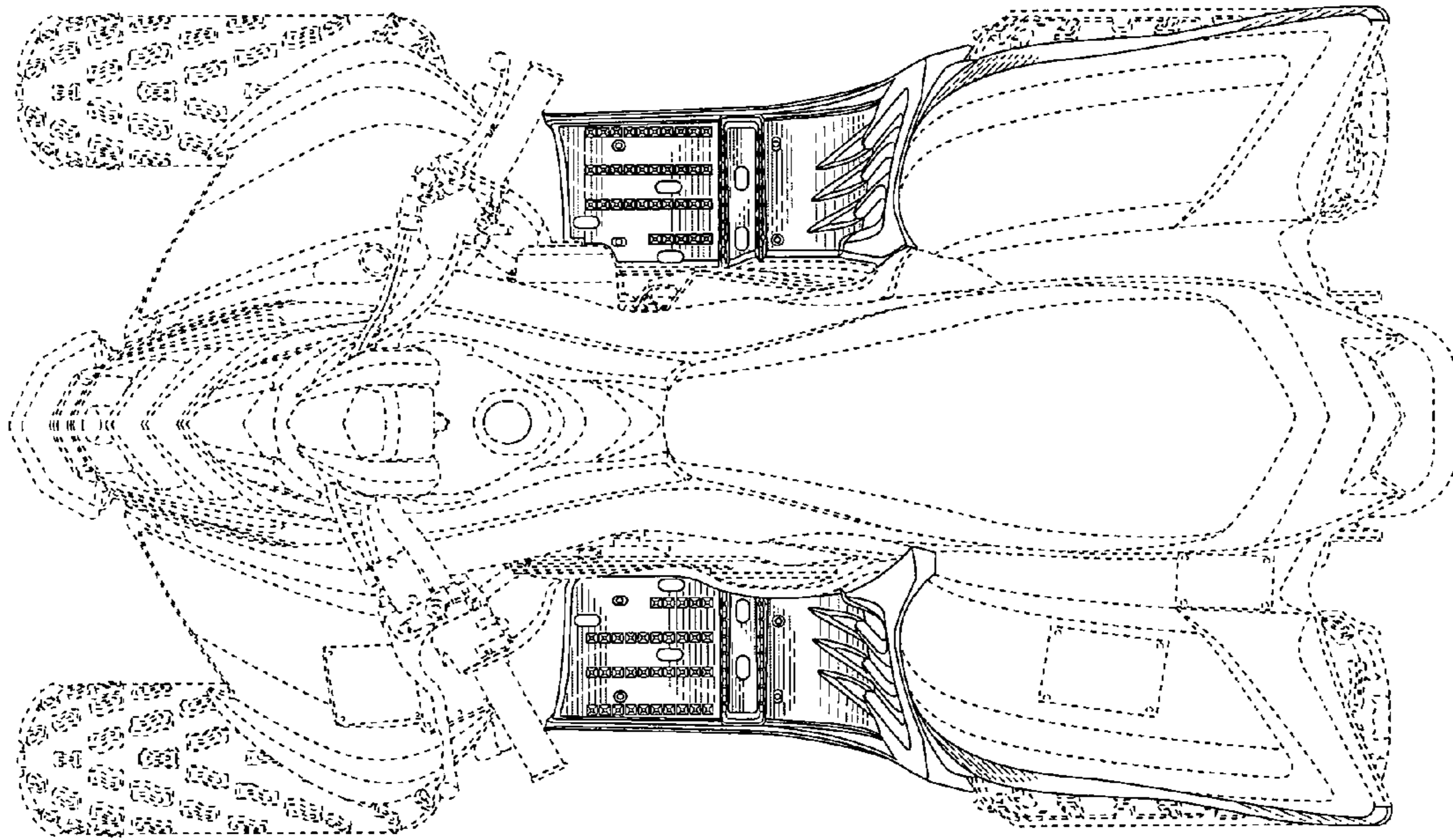

Fig. 6

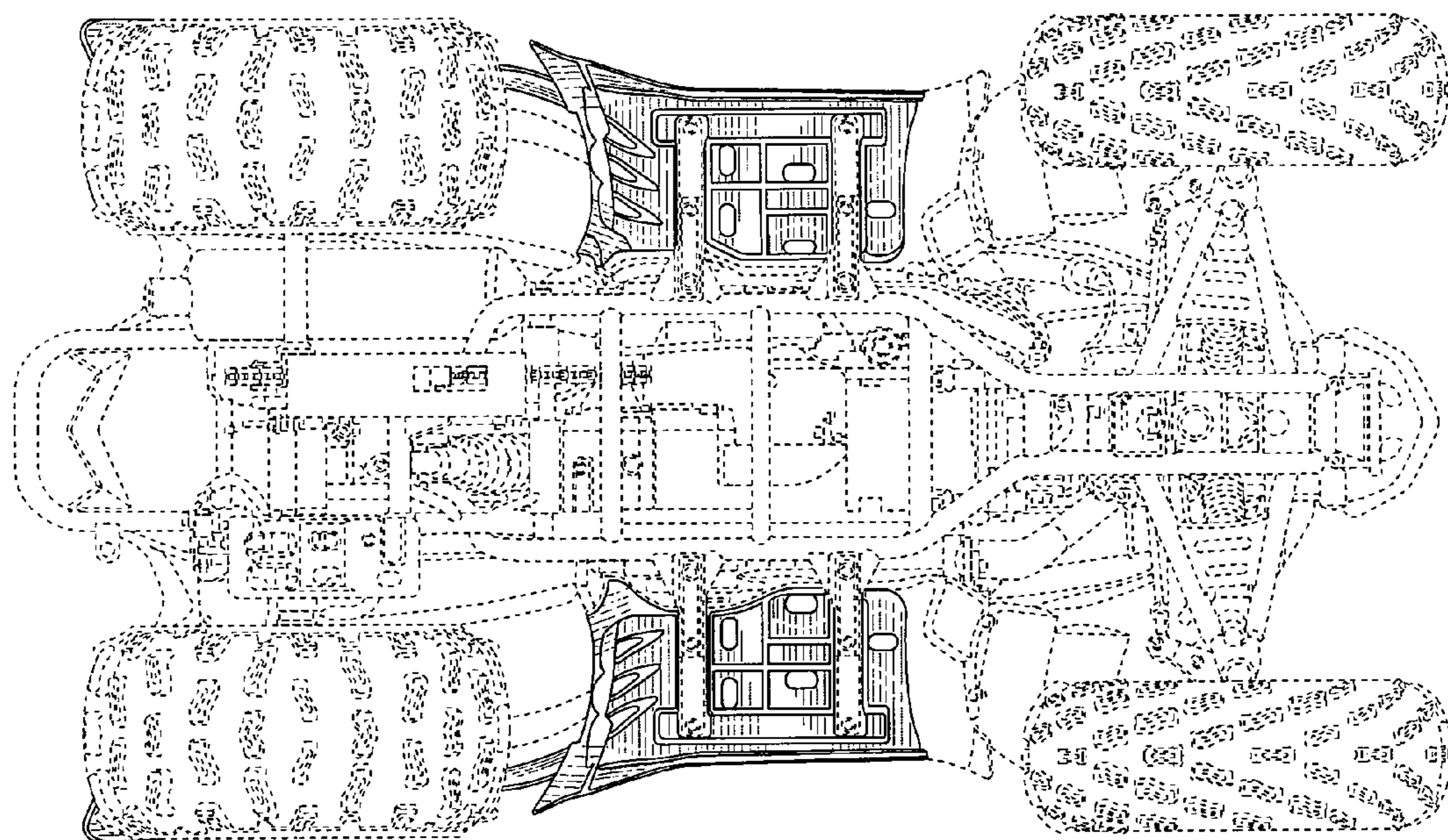

Fig. 7