



US00D600006S

(12) **United States Design Patent**
Lau

(10) **Patent No.:** **US D600,006 S**
(45) **Date of Patent:** **** Sep. 15, 2009**

(54) **TOBACCO CHEW CASE**

(76) Inventor: **Yiu Ming Lau**, Flat F, 12/F, Block 2,
Botania Villa, 138 Fuk Hang Tsuen
Road, Tuen Mun, N.T. (HK)

(**) Term: **14 Years**

(21) Appl. No.: **29/328,435**

(22) Filed: **Nov. 24, 2008**

(51) **LOC (9) Cl.** **03-01**

(52) **U.S. Cl.** **D3/215; D3/229; D27/186**

(58) **Field of Classification Search** D3/215,
D3/226, 228, 229, 230, 243, 299; D27/172,
D27/183, 186–187, 189–191; 224/163, 247,
224/240, 675, 677, 681, 683, 901.45, 901.6,
224/904; 206/37–38, 236, 242, 248, 260;
24/3.7, 163 K

See application file for complete search history.

(56) **References Cited**

U.S. PATENT DOCUMENTS

1,777,543	A *	10/1930	Bashe et al.	24/3.7
D196,542	S *	10/1963	Zelnick	D3/228
D237,428	S *	11/1975	Baker	D3/226
3,949,916	A *	4/1976	Yount	224/240
D263,767	S *	4/1982	Sogoian et al.	D3/230
D271,061	S *	10/1983	Zimmerman	D3/229
4,562,620	A *	1/1986	Oliver, Jr.	224/163
4,598,027	A *	7/1986	Johnson	224/904
D387,897	S *	12/1997	Yorke et al.	D3/215
D548,957	S *	8/2007	Lowe	D3/215

D559,531 S * 1/2008 Koppe D3/215

* cited by examiner

Primary Examiner—Catherine R Oliver

(74) *Attorney, Agent, or Firm*—Kauth, Pomeroy, Peck &
Bailey LLP

(57) **CLAIM**

The ornamental design for a tobacco chew case, as shown and described.

DESCRIPTION

FIG. 1 is a top perspective view of a tobacco holder according to my new design;

FIG. 2 is a top plan view of the tobacco holder of FIG. 1;

FIG. 3 is a front view of the tobacco holder of FIG. 1;

FIG. 4 is a bottom view of the tobacco holder of FIG. 1;

FIG. 5 is a rear view of the tobacco holder of FIG. 1;

FIG. 6 is a side view of the tobacco holder of FIG. 1;

FIG. 7 is a further side view of the tobacco holder of FIG. 1;

FIG. 8 is a top perspective view of a second embodiment of a tobacco holder according to my new design;

FIG. 9 is a top plan view of the tobacco holder of FIG. 8;

FIG. 10 is a front view of the tobacco holder of FIG. 8;

FIG. 11 is a bottom view of the tobacco holder of FIG. 8;

FIG. 12 is a rear view of the tobacco holder of FIG. 8;

FIG. 13 is a side view of the tobacco holder of FIG. 8; and,

FIG. 14 is a further side view of the tobacco holder of FIG. 8.

1 Claim, 14 Drawing Sheets

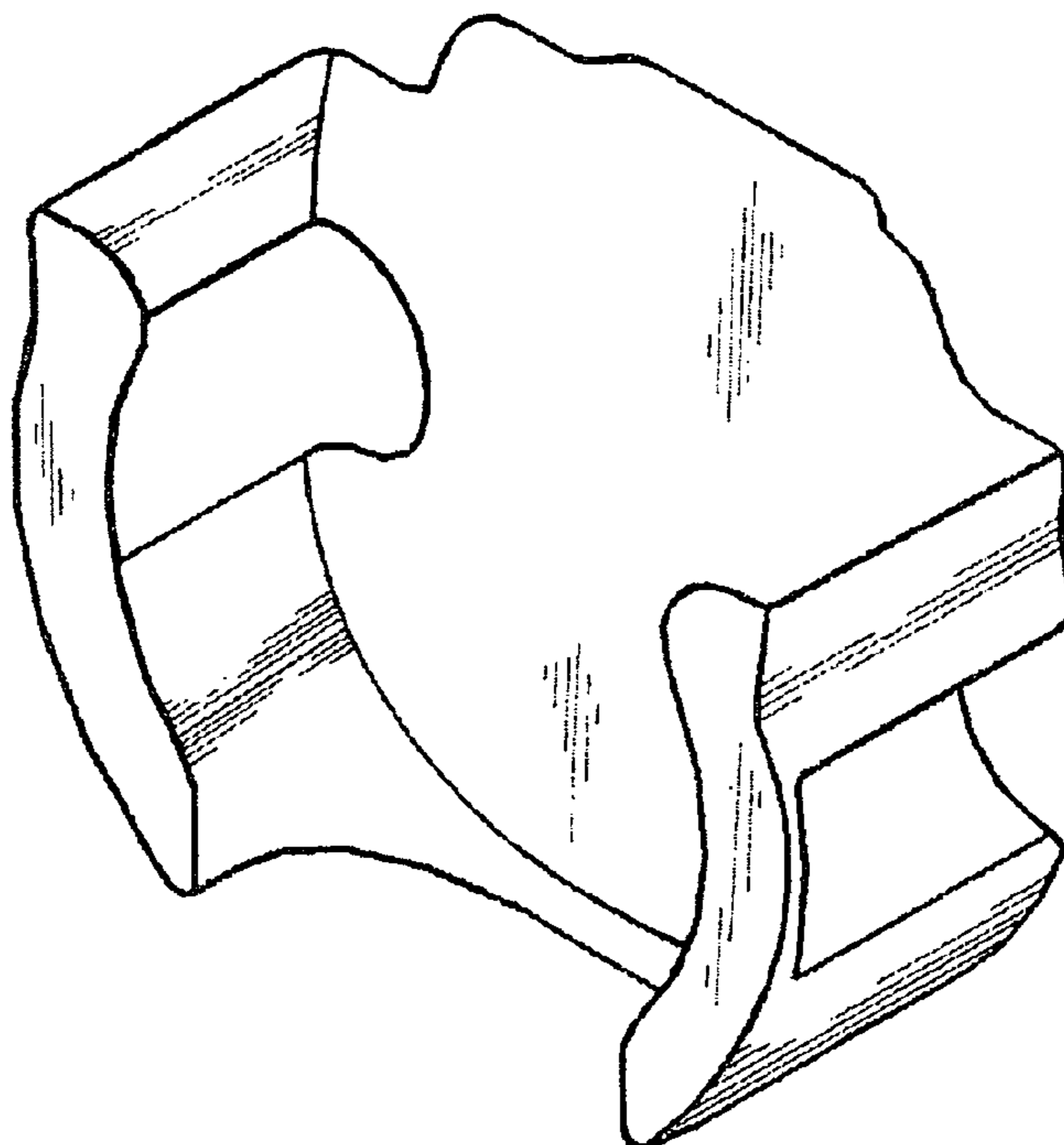

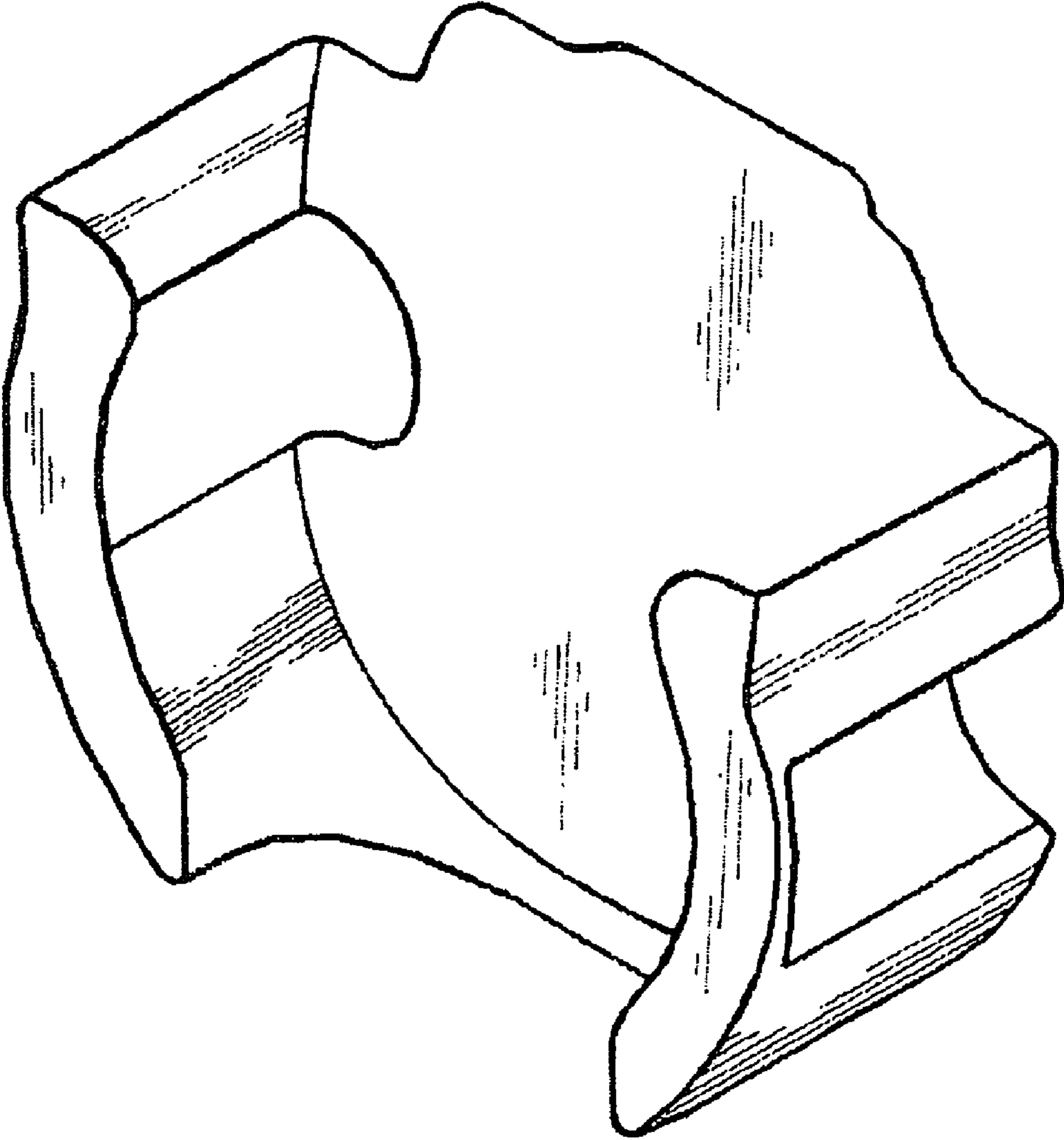

FIG. 1

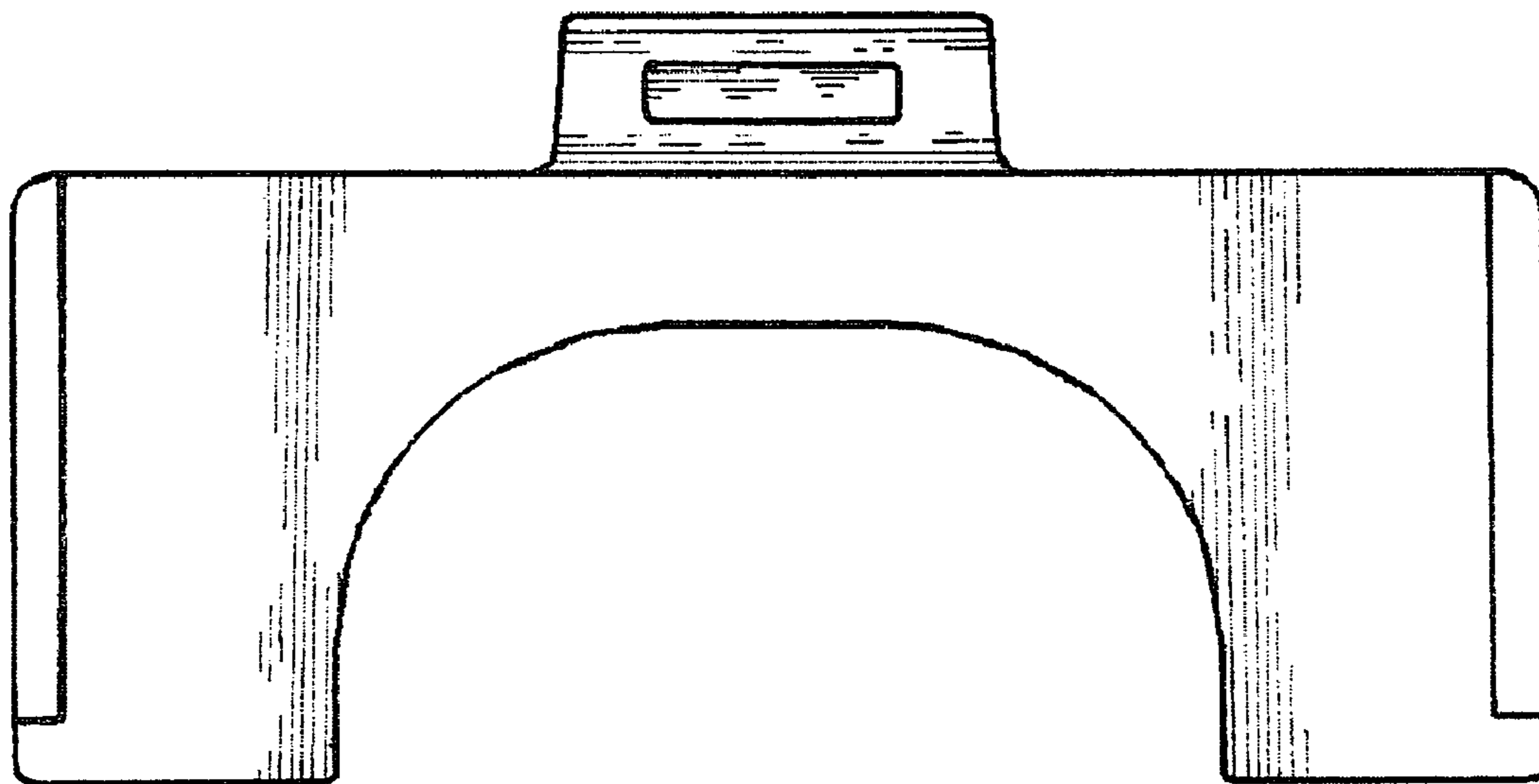

FIG. 2

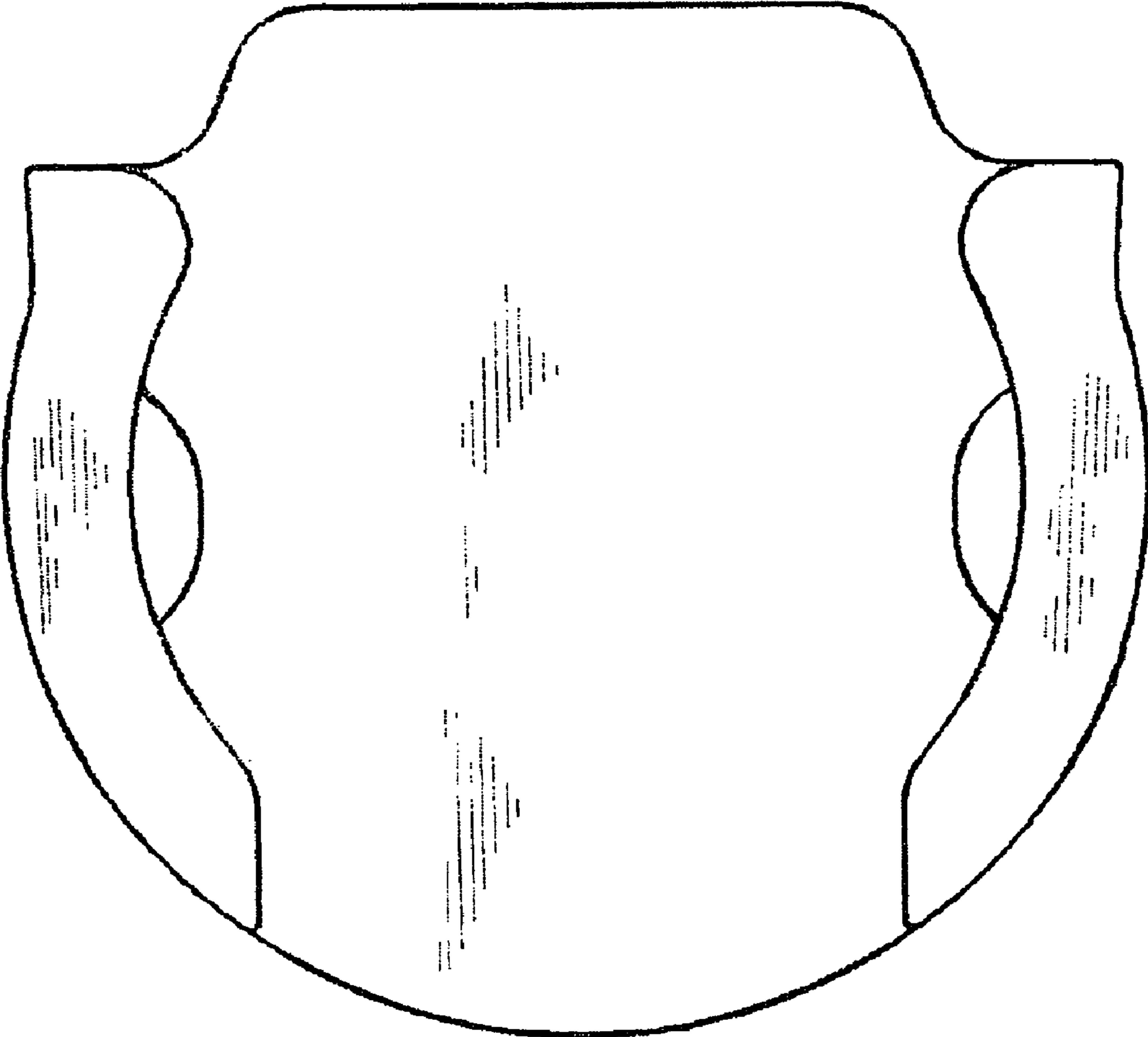

FIG. 3

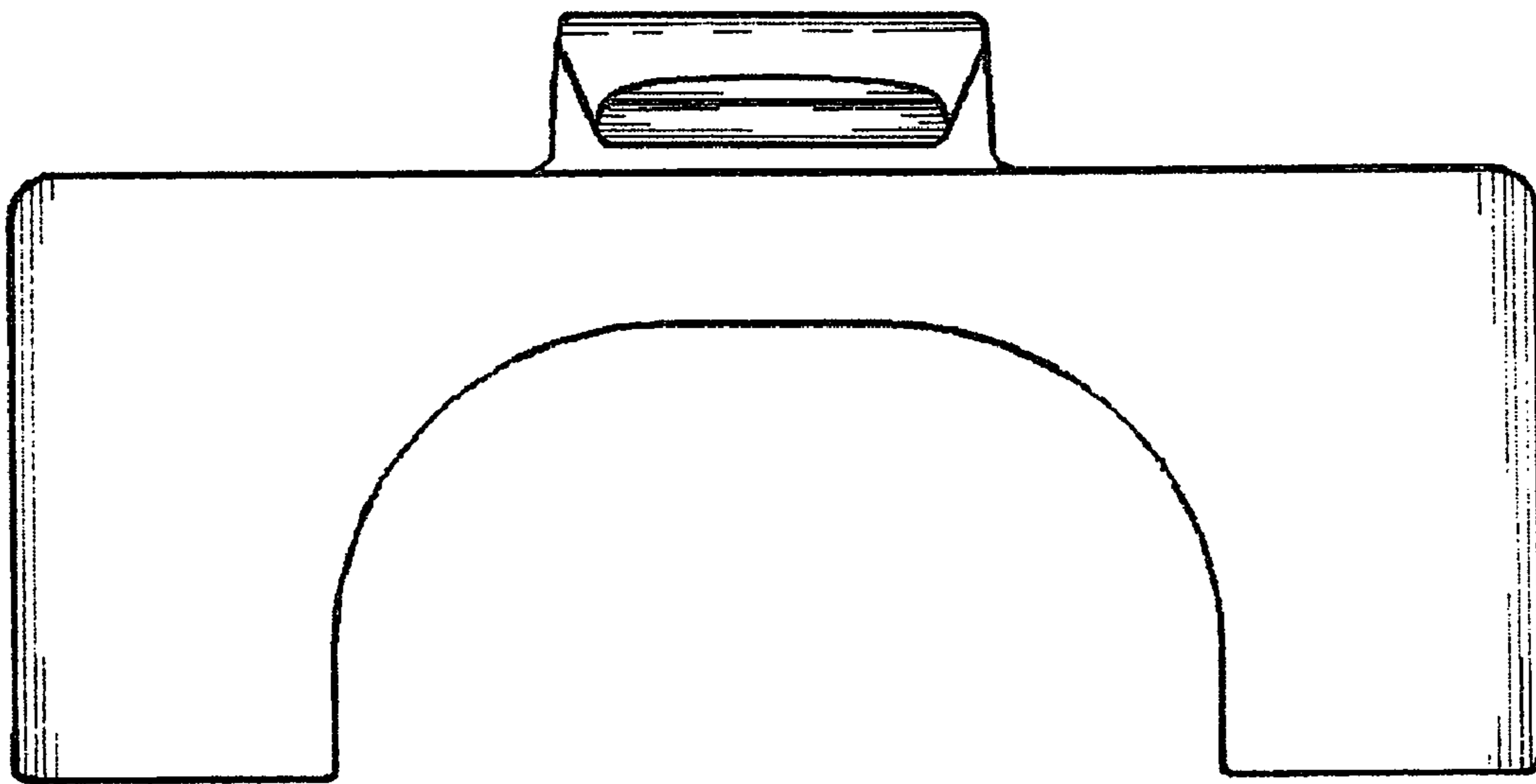

FIG. 4

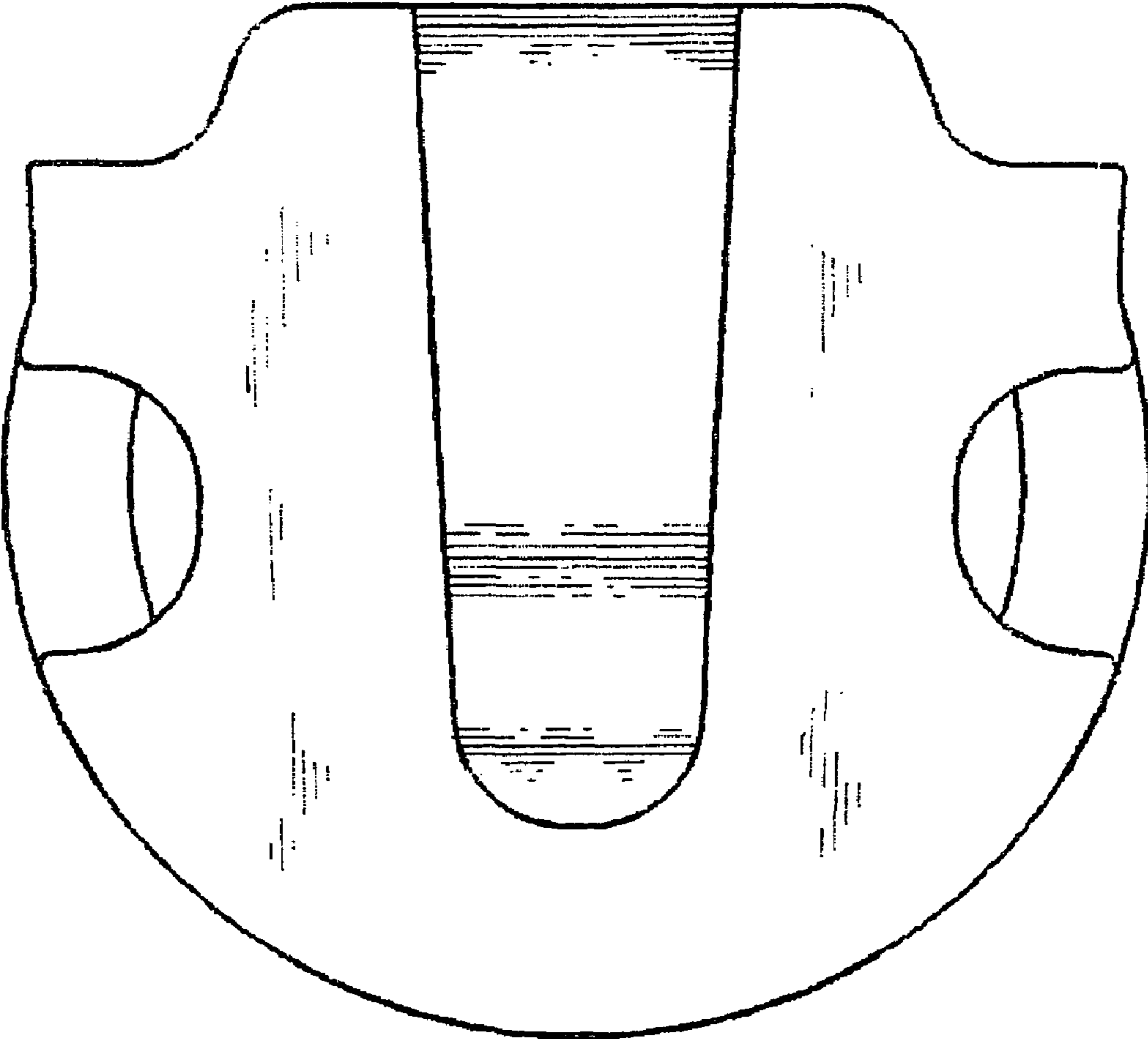

FIG. 5

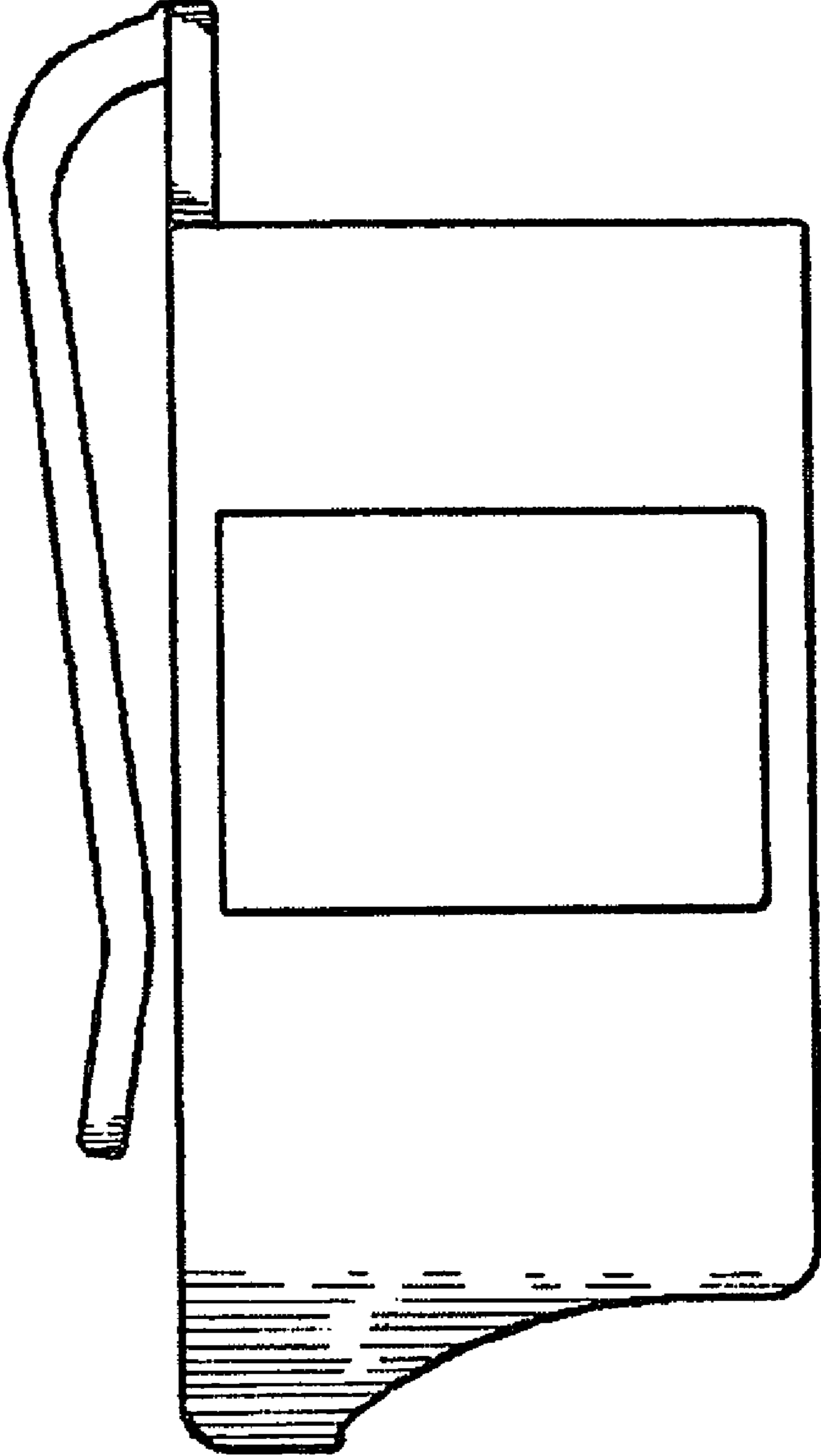

FIG. 6

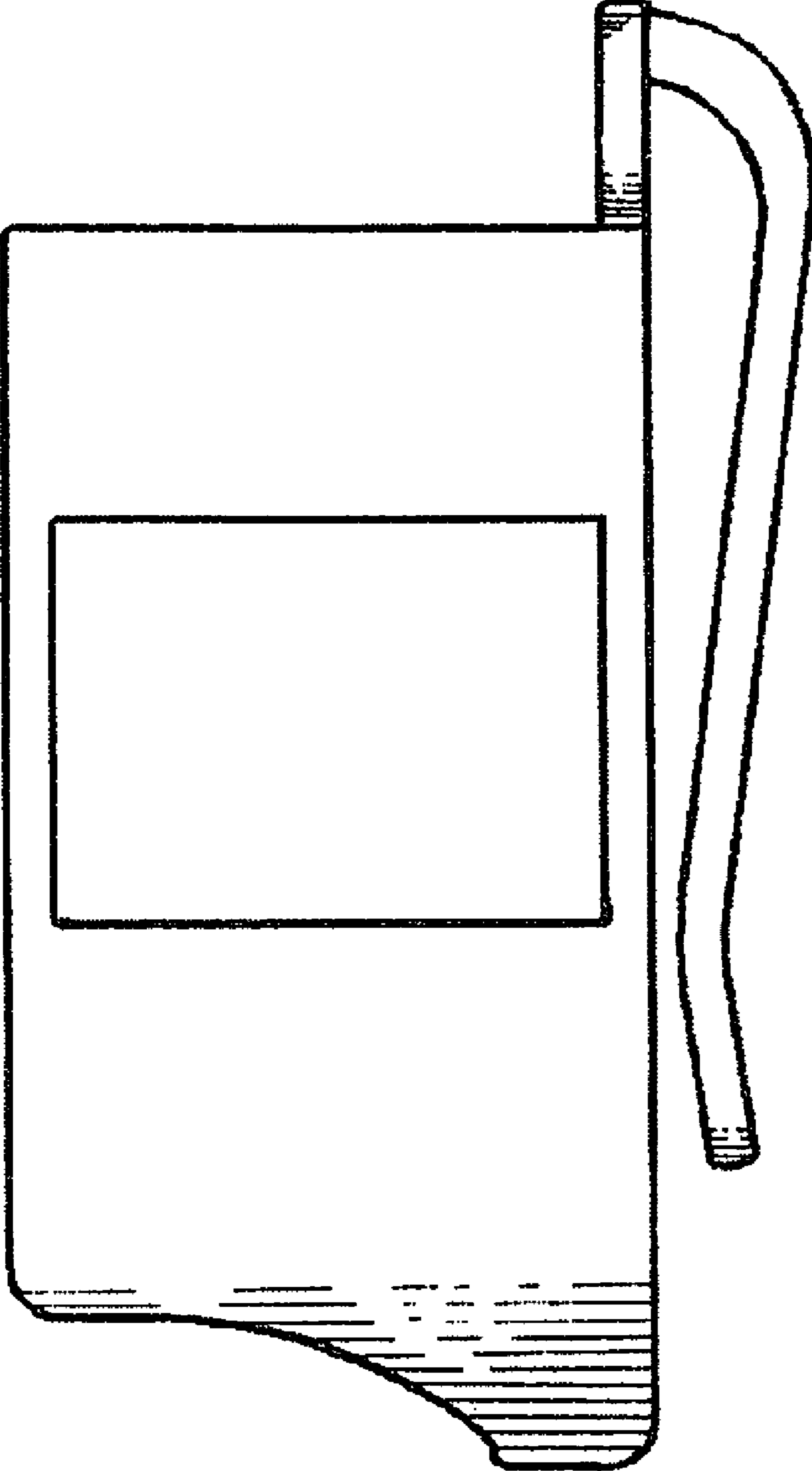

FIG. 7

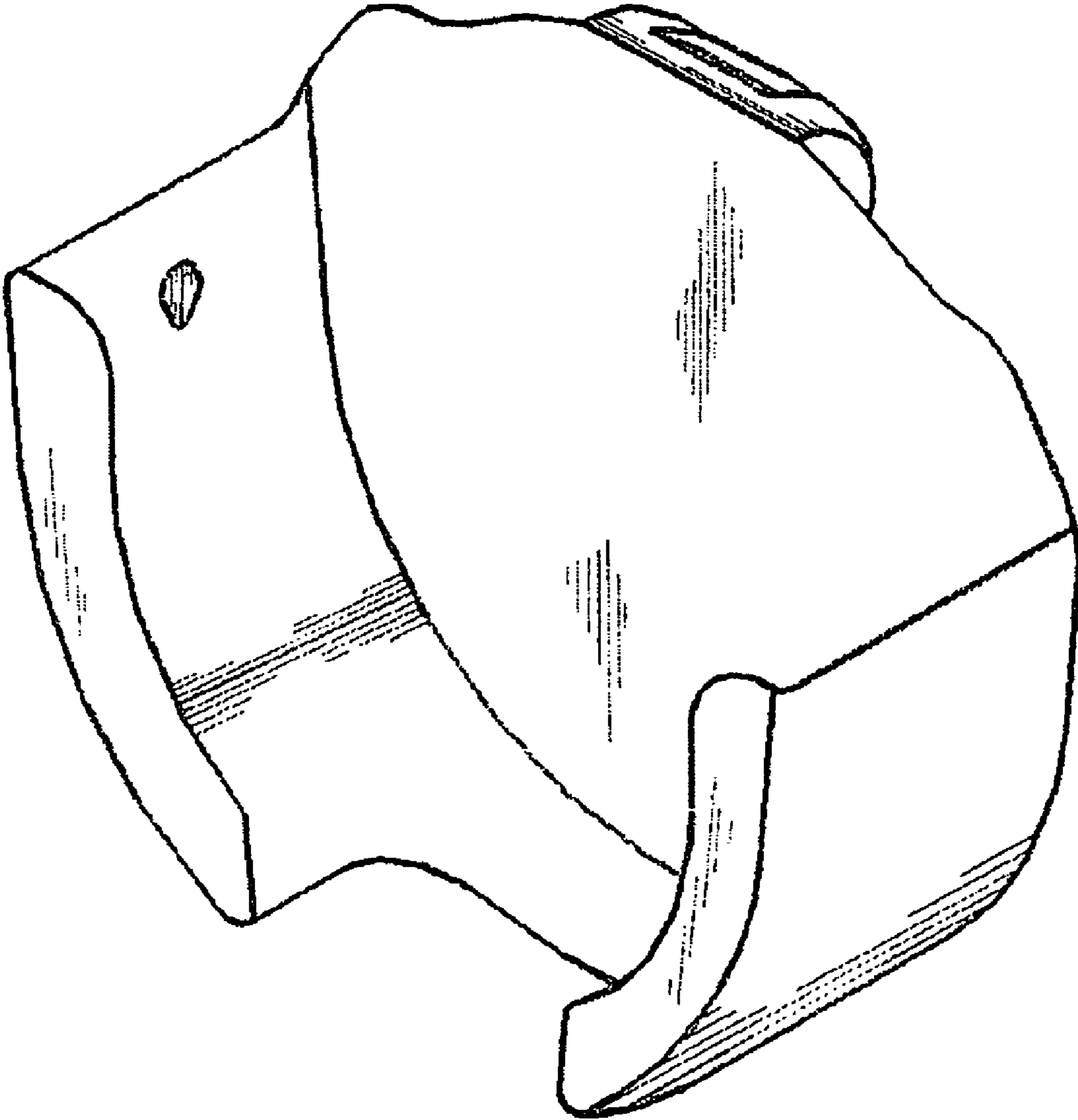

FIG. 8

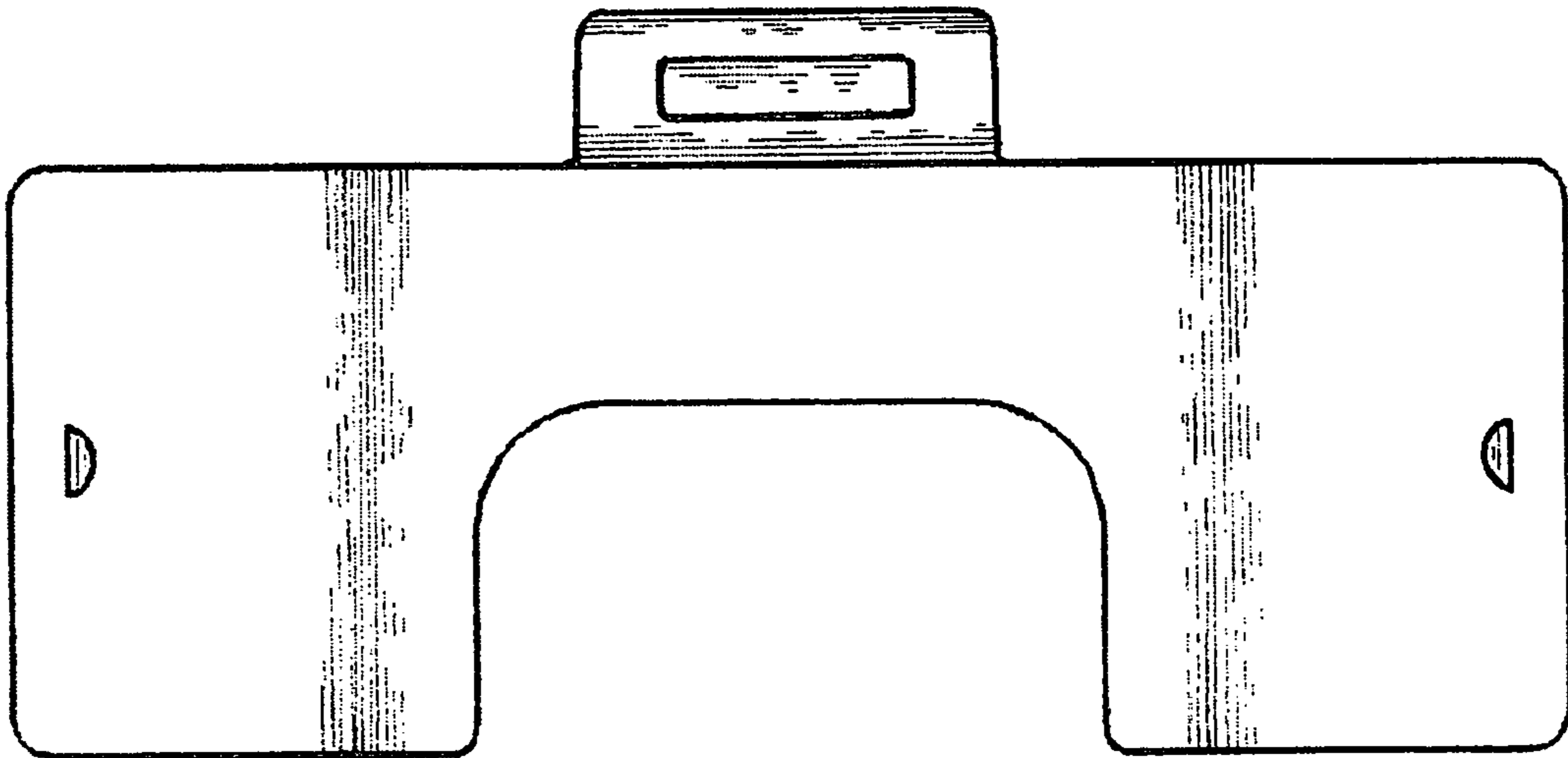

FIG. 9

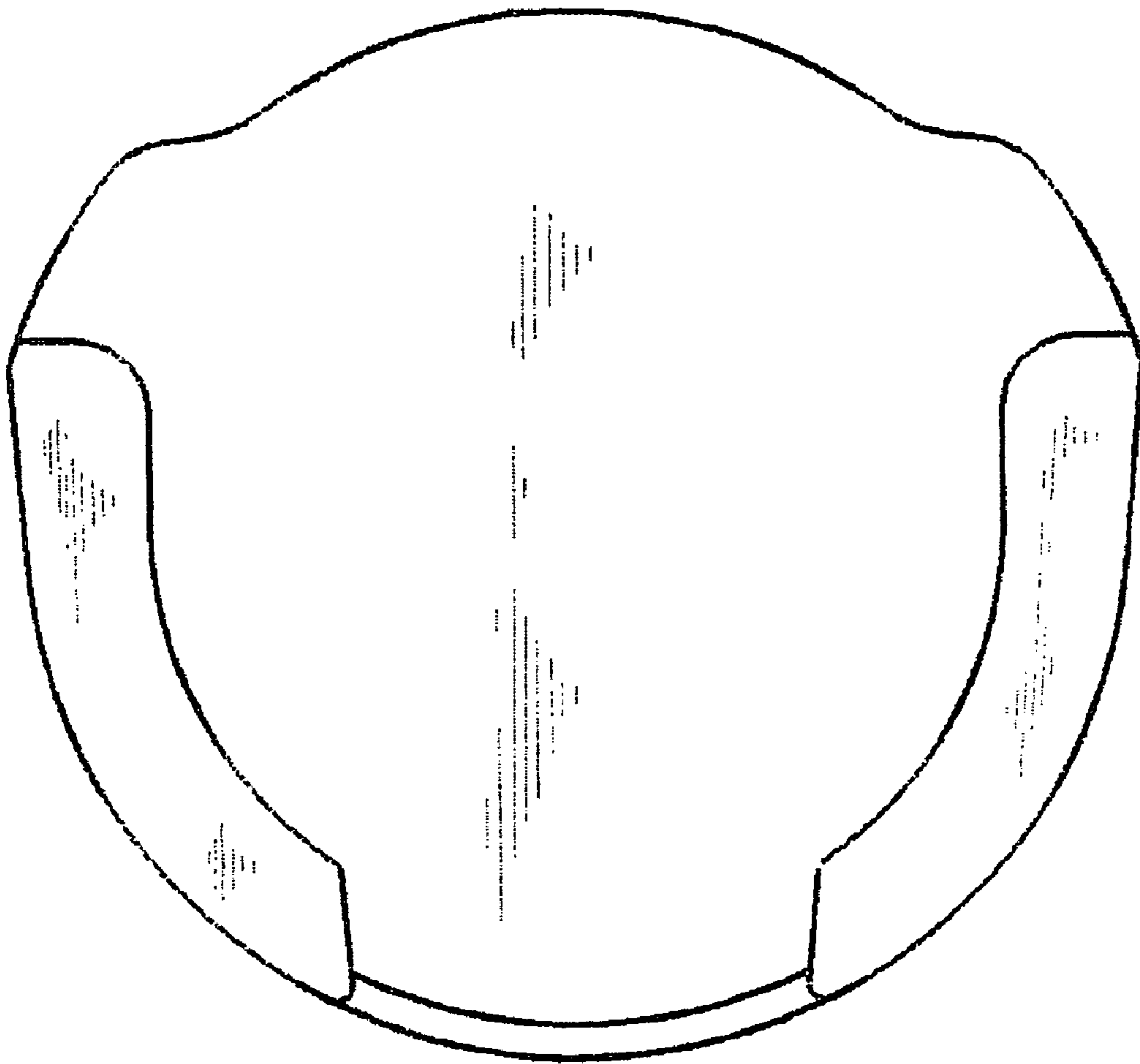

FIG. 10

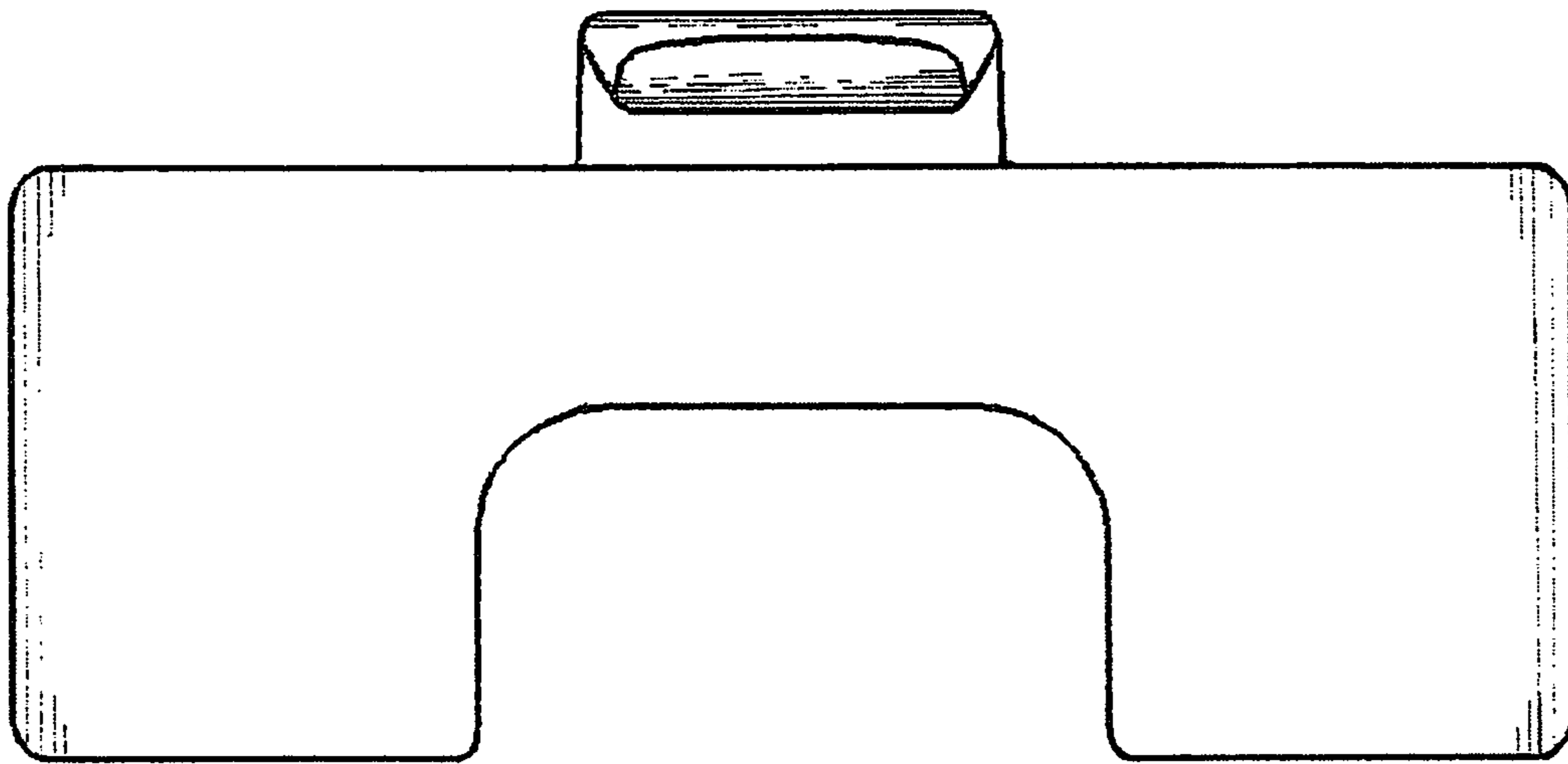

FIG. 11

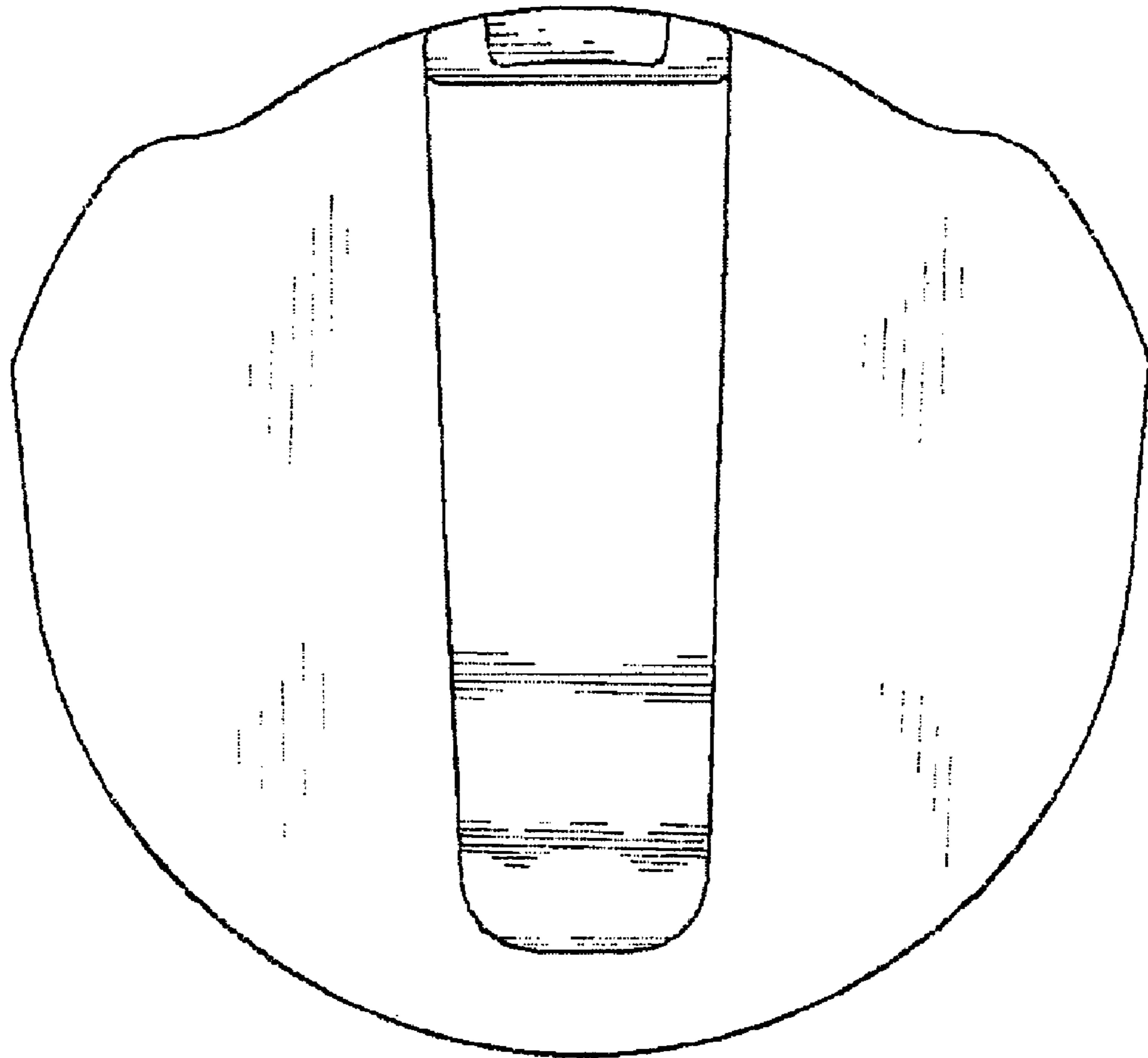

FIG. 12

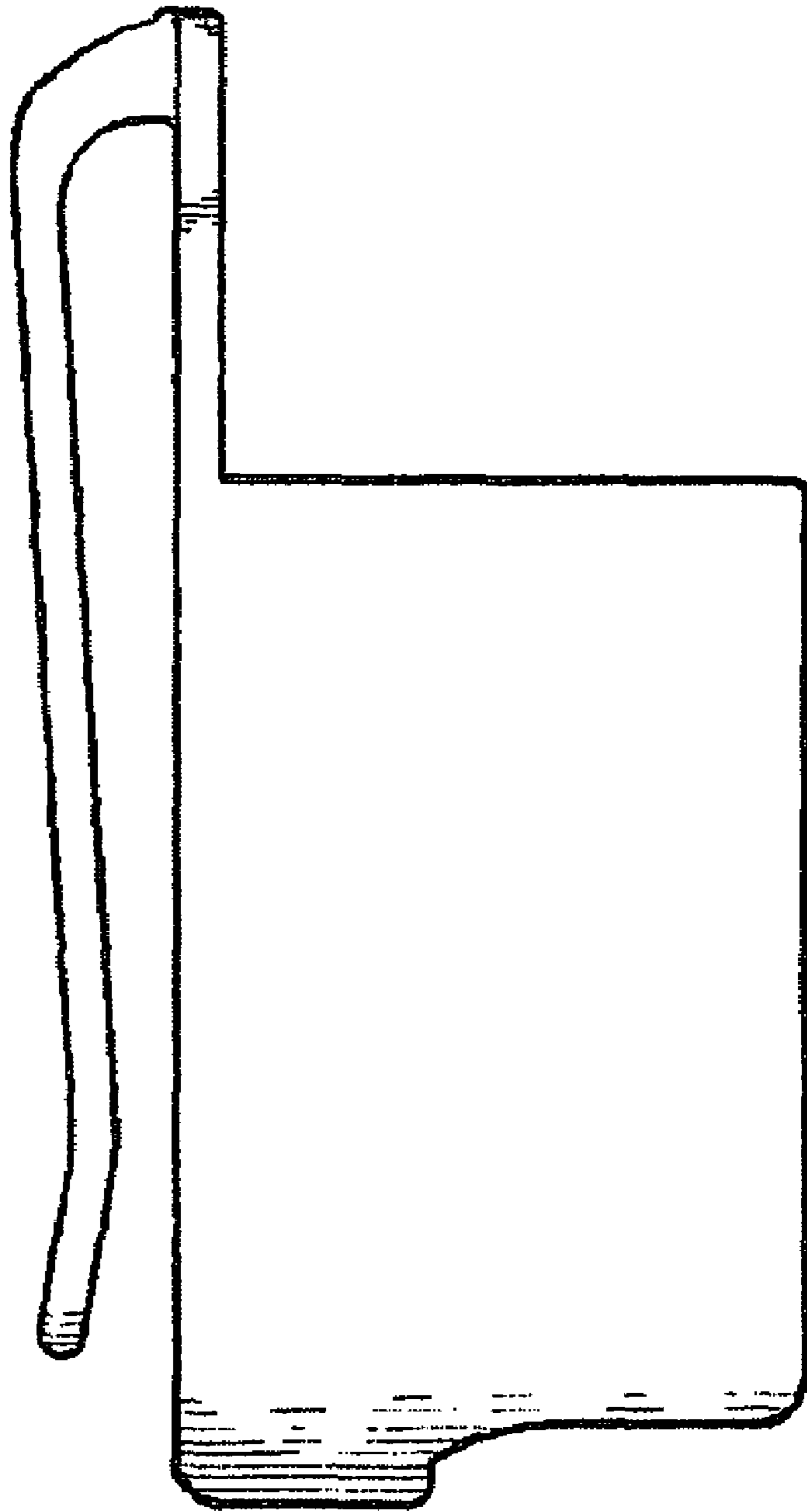

FIG. 13

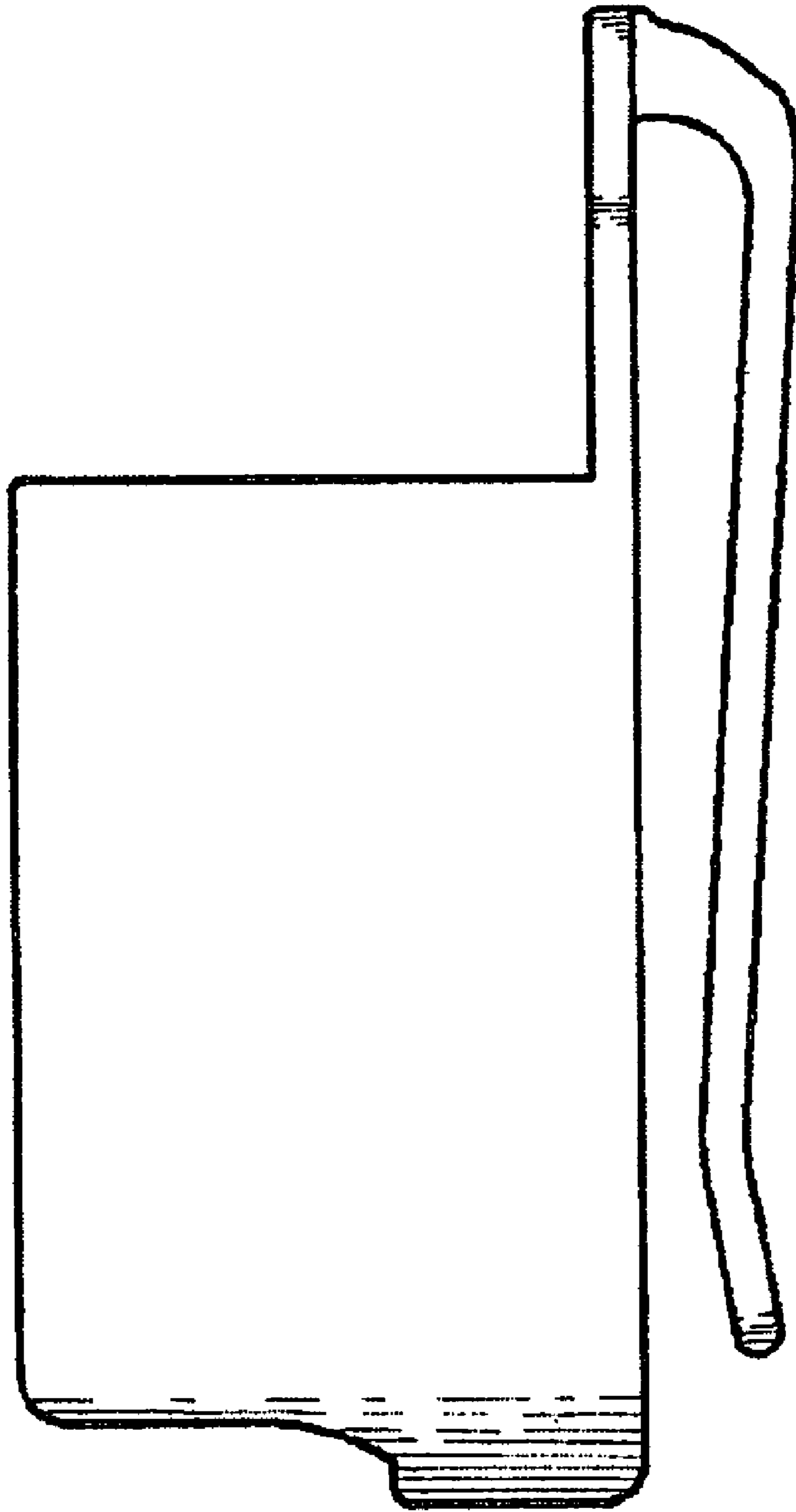

FIG. 14