



US00D599942S

(12) **United States Design Patent**
Zheng

(10) **Patent No.:** **US D599,942 S**

(45) **Date of Patent:** **** Sep. 8, 2009**

(54) **LED LAMP**

(75) Inventor: **Shi-Song Zheng**, Shenzhen (CN)

(73) Assignee: **Foxconn Technology Co., Ltd.**,
Tu-Cheng, Taipei Hsien (TW)

(**) Term: **14 Years**

(21) Appl. No.: **29/324,637**

(22) Filed: **Sep. 17, 2008**

(51) **LOC (9) Cl.** **26-05**

(52) **U.S. Cl.** **D26/71**

(58) **Field of Classification Search** D26/67-72,
D26/85, 92; 362/145, 152, 183, 294, 373,
362/414, 431, 545, 800

See application file for complete search history.

(56) **References Cited**

U.S. PATENT DOCUMENTS

2,916,609	A *	12/1959	Freier et al.	362/374
D198,812	S *	8/1964	Pettengill	D26/71
6,784,357	B1 *	8/2004	Wang	362/183
D556,935	S *	12/2007	Quioque et al.	D26/71
D573,292	S *	7/2008	Zheng et al.	D26/71

D573,741	S *	7/2008	Lou	D26/71
D577,455	S *	9/2008	Zheng et al.	D26/71
D578,697	S *	10/2008	Zheng et al.	D26/71
2004/0196653	A1 *	10/2004	Clark et al.	362/183
2008/0298051	A1 *	12/2008	Chu	362/183

* cited by examiner

Primary Examiner—Clare E Heflin

(74) *Attorney, Agent, or Firm*—Frank R. Niranjana

(57) **CLAIM**

The ornamental design for an LED lamp, as shown.

DESCRIPTION

FIG. 1 is a perspective view of an LED lamp showing my new design.

FIG. 2 is a front elevational view thereof.

FIG. 3 is a rear elevational view thereof.

FIG. 4 is a left-side, elevational view thereof.

FIG. 5 is a right-side, elevational view thereof.

FIG. 6 is a top plan view thereof; and,

FIG. 7 is a bottom plan view thereof.

1 Claim, 7 Drawing Sheets

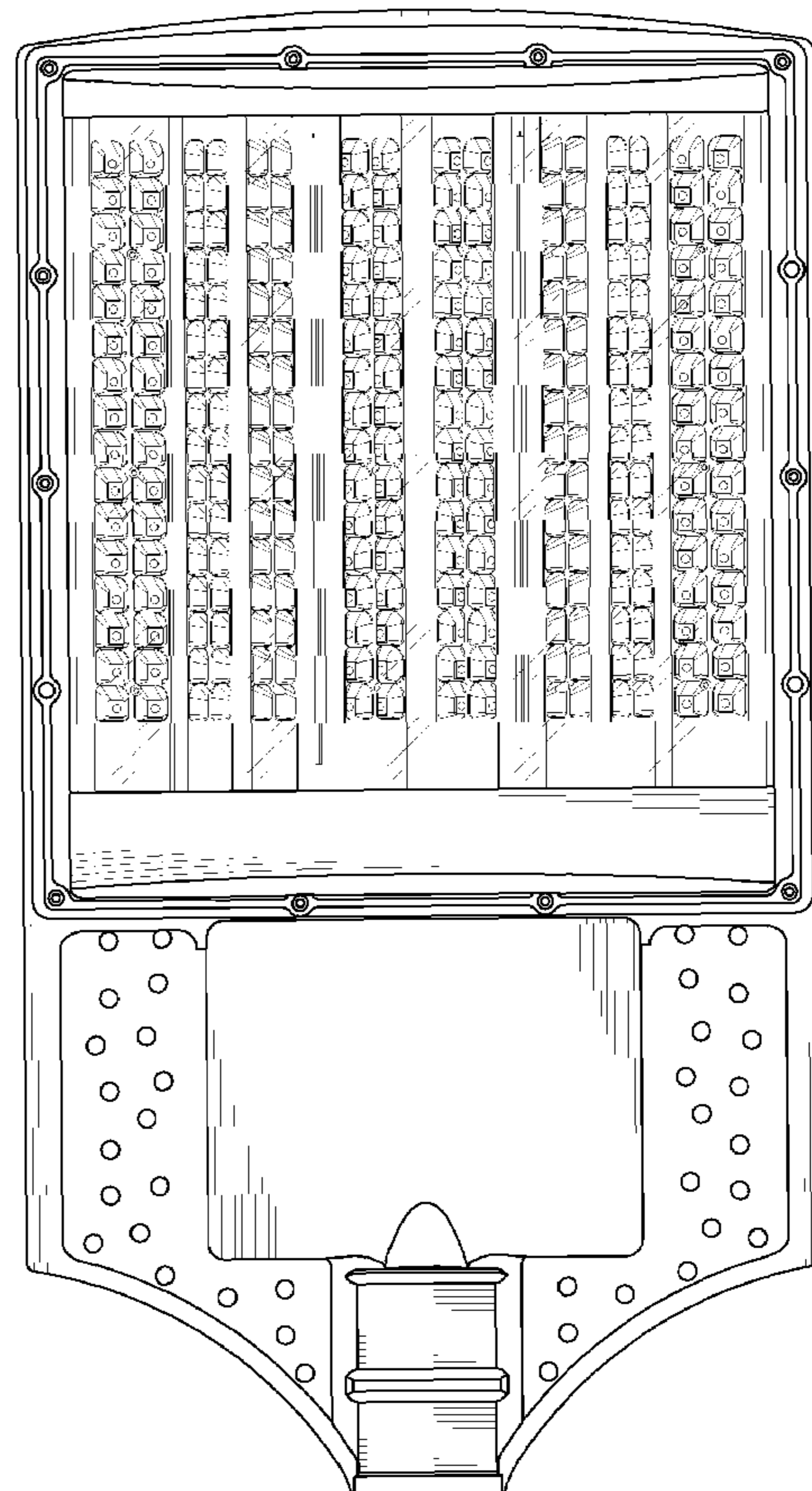
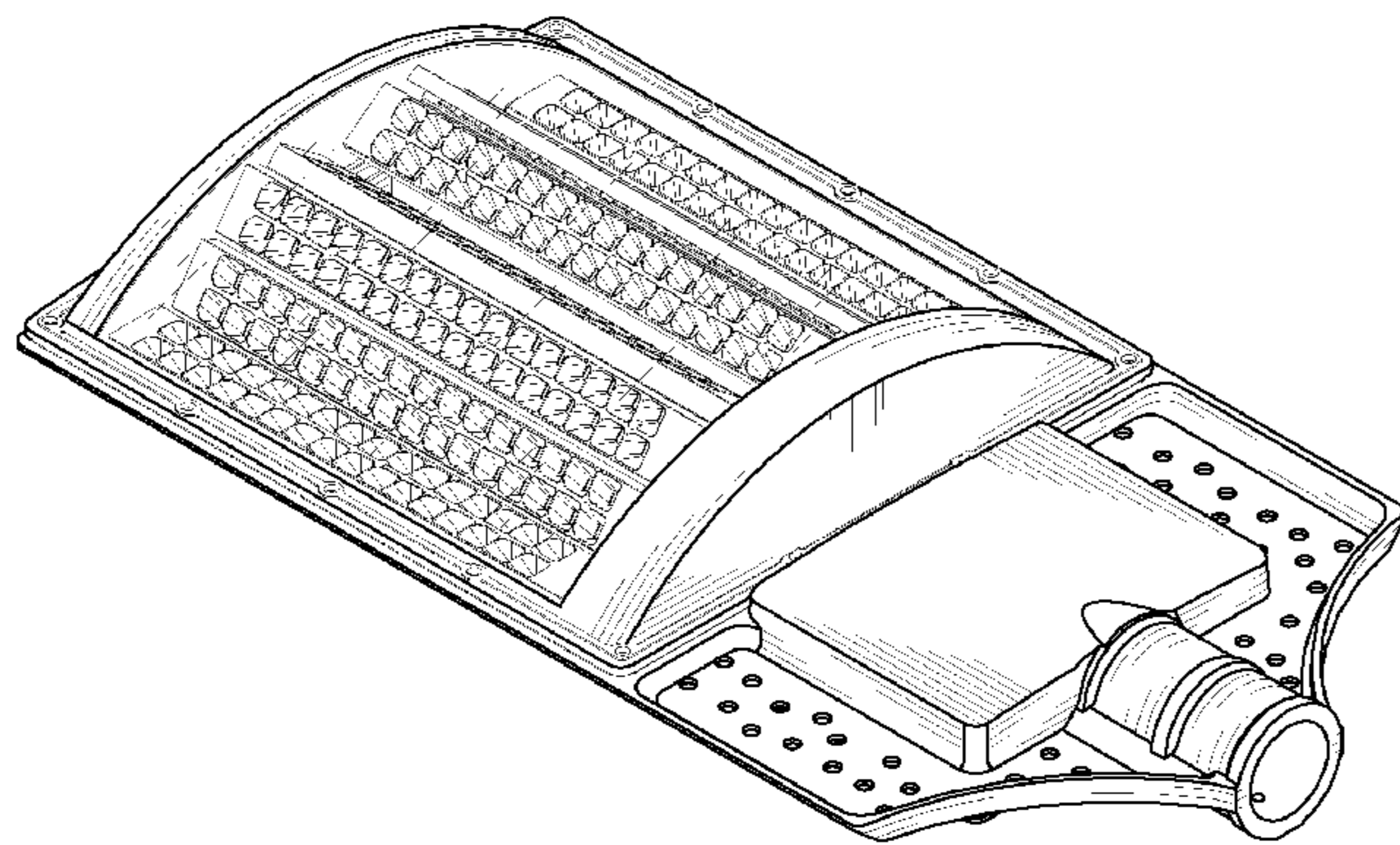

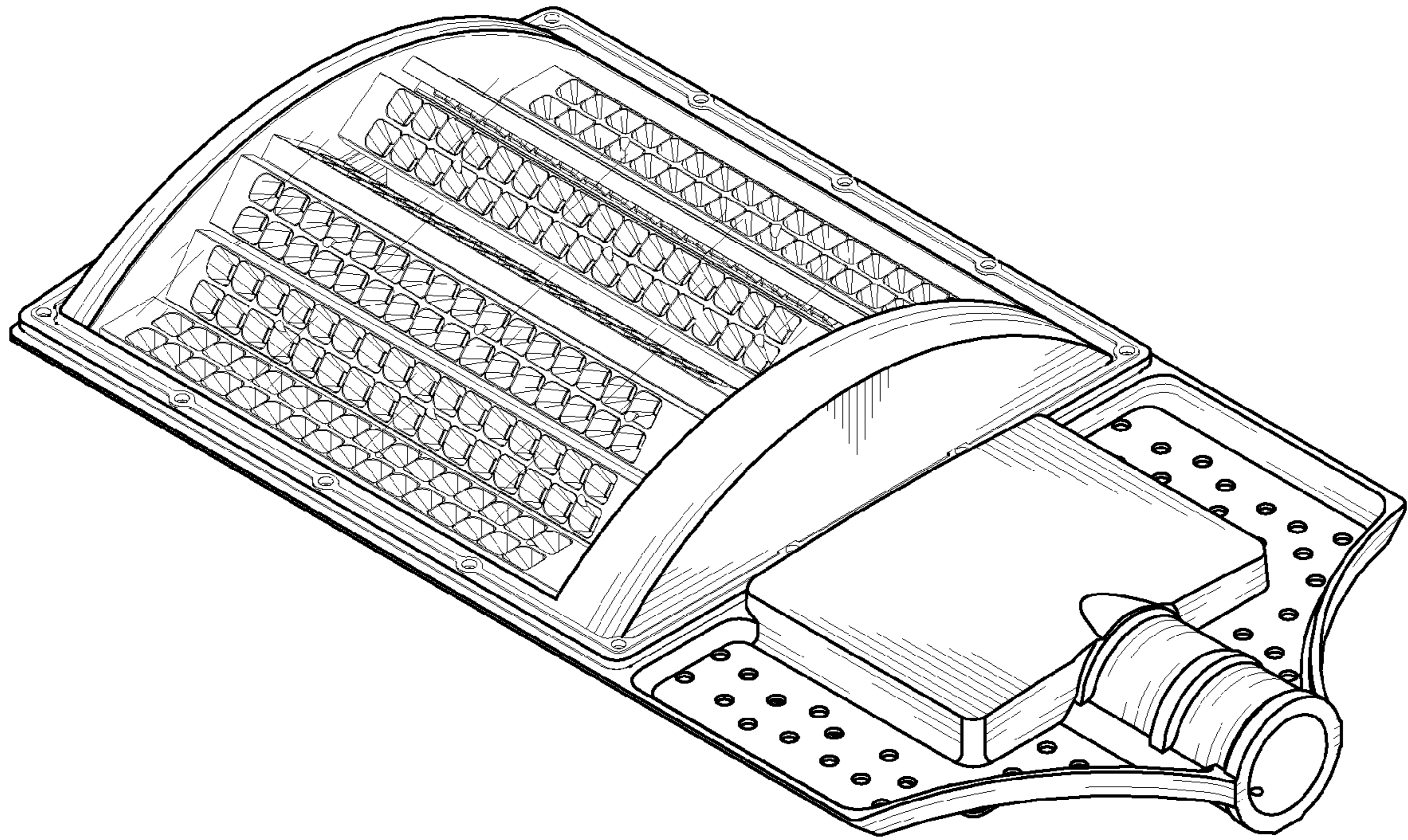

FIG. 1

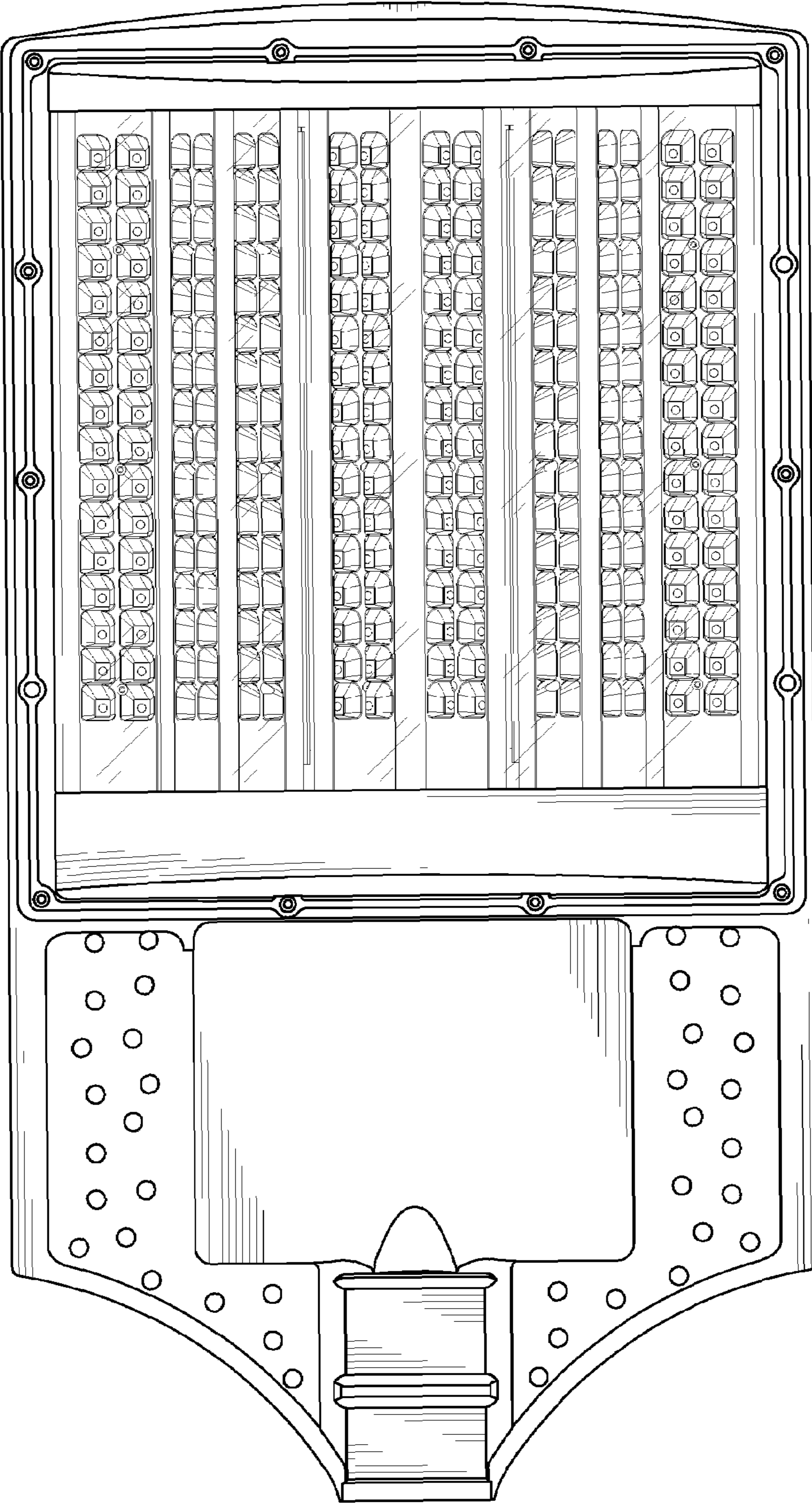

FIG. 2

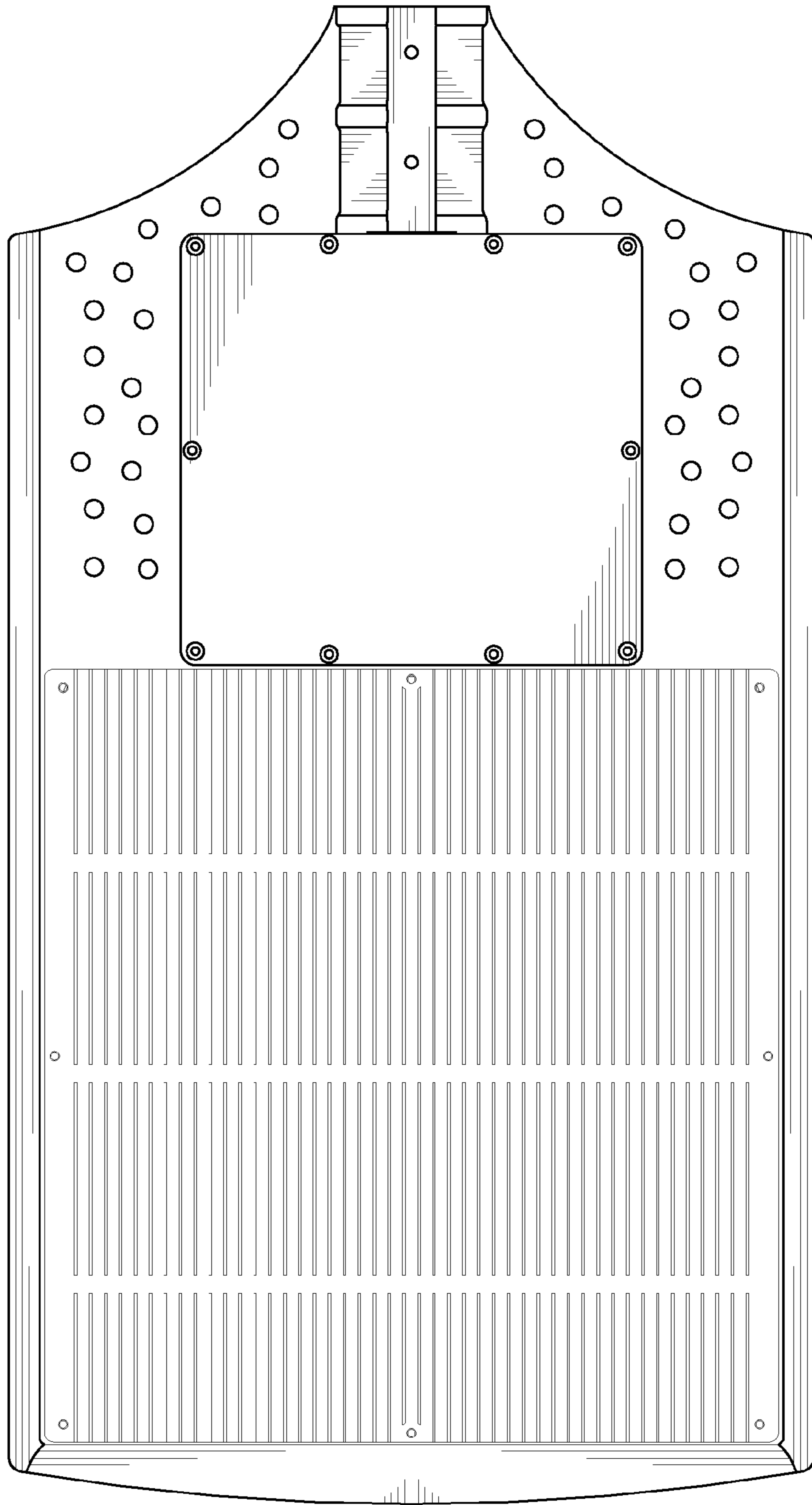

FIG. 3



FIG. 4



FIG. 5

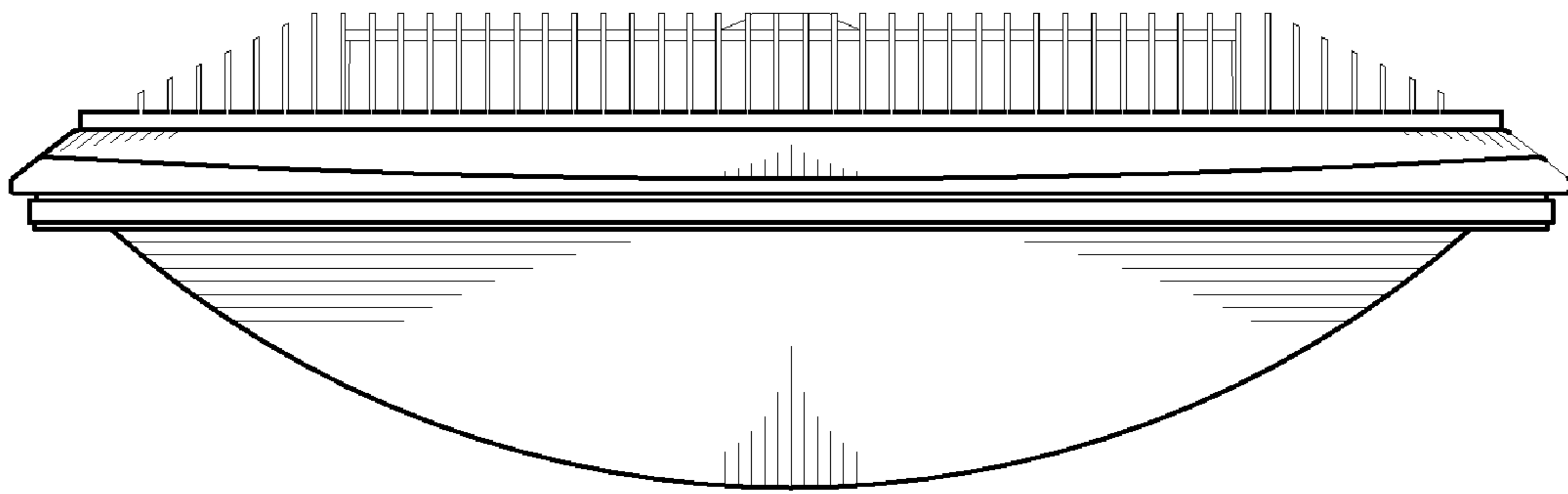

FIG. 6

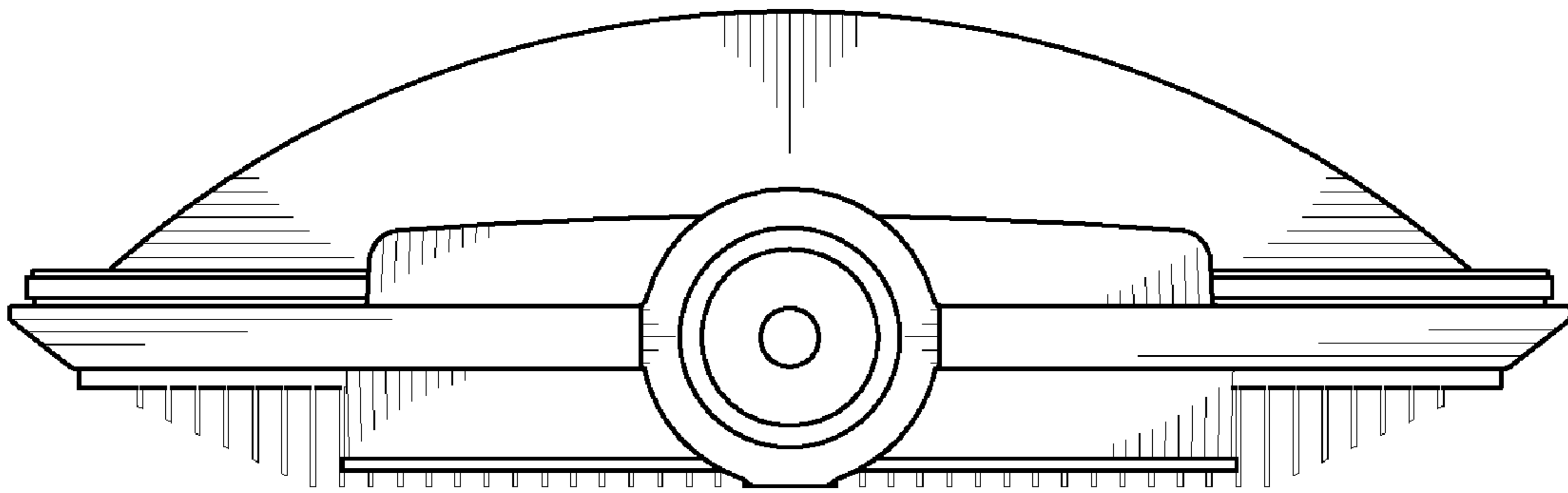

FIG. 7