

US00D599880S

(12) **United States Design Patent**
Rampen et al.

(10) **Patent No.:** **US D599,880 S**

(45) **Date of Patent:** **** Sep. 8, 2009**

(54) **FILTER CARTRIDGE**

(75) Inventors: **Edmond Rampen**, Oakville (CA); **Scott MacDonald**, Toronto (CA)

(73) Assignee: **Envirogard Products Limited**, Ontario (CA)

(**) Term: **14 Years**

(21) Appl. No.: **29/328,688**

(22) Filed: **Dec. 1, 2008**

Related U.S. Application Data

(63) Continuation of application No. 12/145,964, filed on Jun. 25, 2008.

(51) **LOC (9) Cl.** **23-01**

(52) **U.S. Cl.** **D23/209**

(58) **Field of Classification Search** D23/207,
D23/209; 210/333.1, 232

See application file for complete search history.

(56) **References Cited**

U.S. PATENT DOCUMENTS

3,746,171 A	7/1973	Thomsen	
3,954,624 A	5/1976	Petrucci	
4,052,307 A	10/1977	Humbert, Jr.	
4,077,876 A	3/1978	Southall	
4,082,673 A	4/1978	Cilentro	
4,222,875 A	9/1980	Sikula, Jr.	
4,645,601 A	2/1987	Regunathan et al.	
4,654,142 A	3/1987	Thomsen et al.	
4,735,716 A	4/1988	Petrucci et al.	
4,857,189 A	8/1989	Thomsen et al.	
4,877,521 A	10/1989	Petrucci et al.	
4,915,831 A	4/1990	Taylor	
4,948,505 A	8/1990	Petrucci et al.	
4,956,086 A	9/1990	Thomsen et al.	
D322,836 S	12/1991	Petrucci et al.	
5,092,999 A	3/1992	Valenzuela et al.	
5,336,406 A	8/1994	Stanford et al.	
D356,625 S *	3/1995	Petrucci et al. D23/209
5,456,830 A	10/1995	Stanford et al.	

5,486,288 A	1/1996	Stanford et al.	
5,591,332 A	1/1997	Reid et al.	
5,725,621 A	3/1998	Pruette et al.	
5,744,030 A	4/1998	Reid et al.	
5,753,107 A	5/1998	Magnusson et al.	
5,826,854 A	10/1998	Janvrin et al.	
5,925,245 A	7/1999	Bradford et al.	
6,027,644 A	2/2000	Magnusson et al.	
D433,094 S *	10/2000	Magnusson et al. D23/209
6,193,884 B1	2/2001	Magnusson et al.	
6,426,001 B1	7/2002	Fritze	
D472,299 S	3/2003	Fritze	
6,533,931 B1	3/2003	Reid	
D472,604 S	4/2003	Fritze	
6,576,129 B1	6/2003	Reid	
6,649,056 B2	11/2003	Fritze	
6,953,526 B1	10/2005	Fritze	
6,977,039 B2	12/2005	Knoll et al.	
D541,371 S *	4/2007	McKay D23/209
D547,821 S *	7/2007	Kennedy et al. D23/207
D548,306 S *	8/2007	Kennedy et al. D23/209

* cited by examiner

Primary Examiner—Robin V Webster

(74) *Attorney, Agent, or Firm*—Tarolli, Sundheim, Covell & Tummino LLP

(57) **CLAIM**

We claim the ornamental design for a filter cartridge, as shown and described.

DESCRIPTION

FIG. 1 is an upper side perspective view of the filter cartridge constructed in accordance with our new design;

FIG. 2 is a front elevation view thereof;

FIG. 3 is a left side elevation view thereof;

FIG. 4 is a right side elevation view thereof;

FIG. 5 is a top view thereof;

FIG. 6 is a rear elevation view thereof; and,

FIG. 7 is an enlarged detail view of the top portion thereof.

The broken lines shown are for illustrative purposes only and form no part of the claimed design.

1 Claim, 7 Drawing Sheets

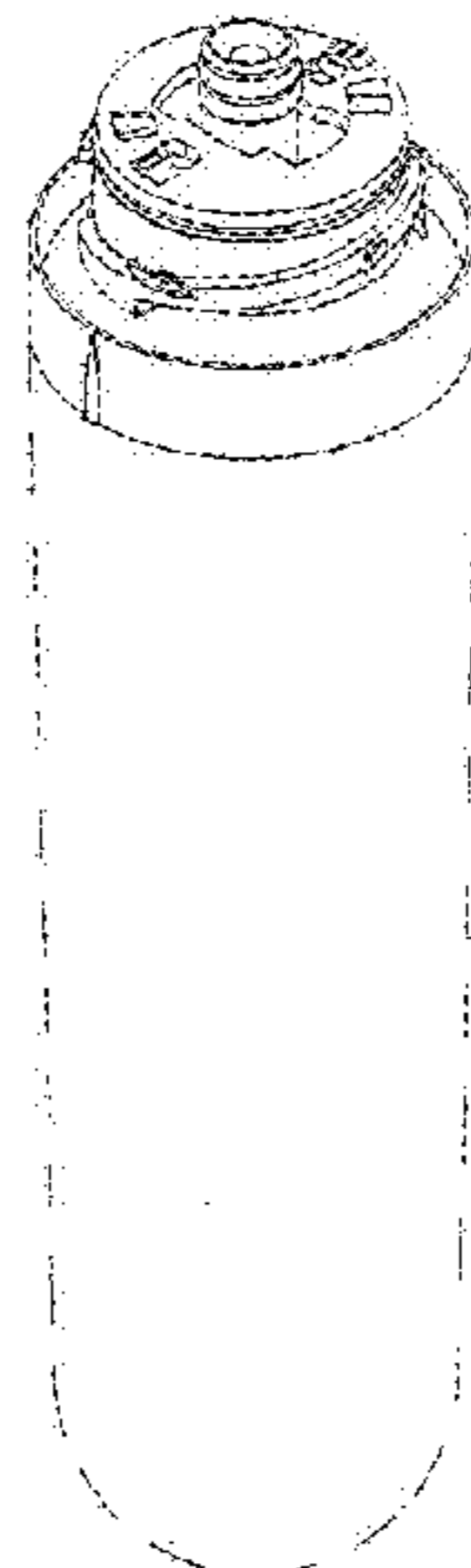

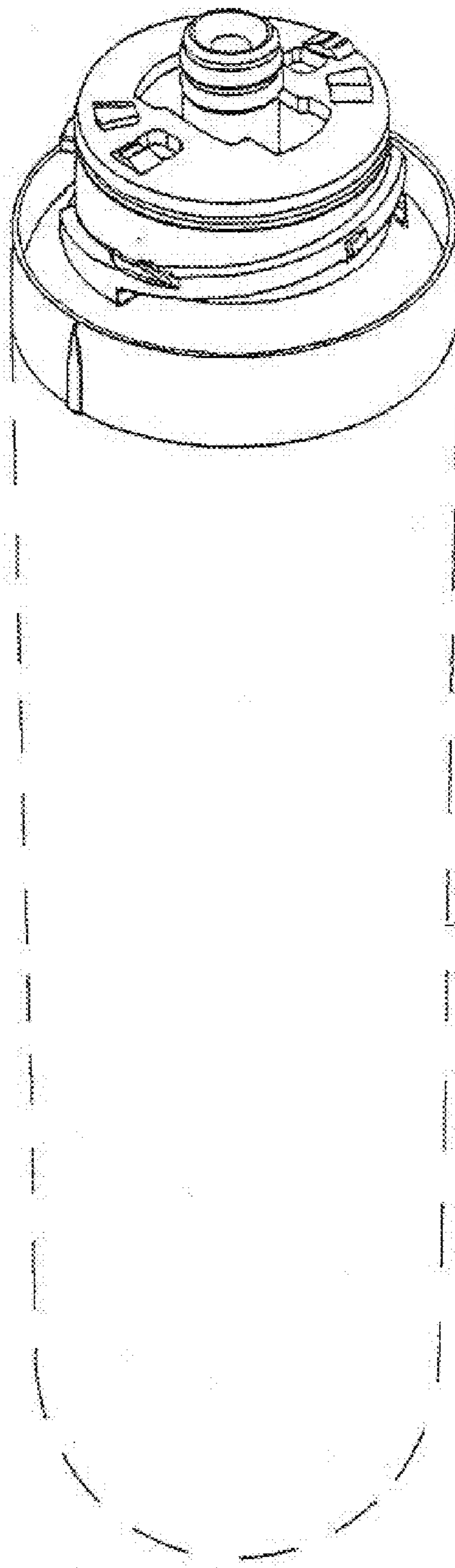

FIGURE 1

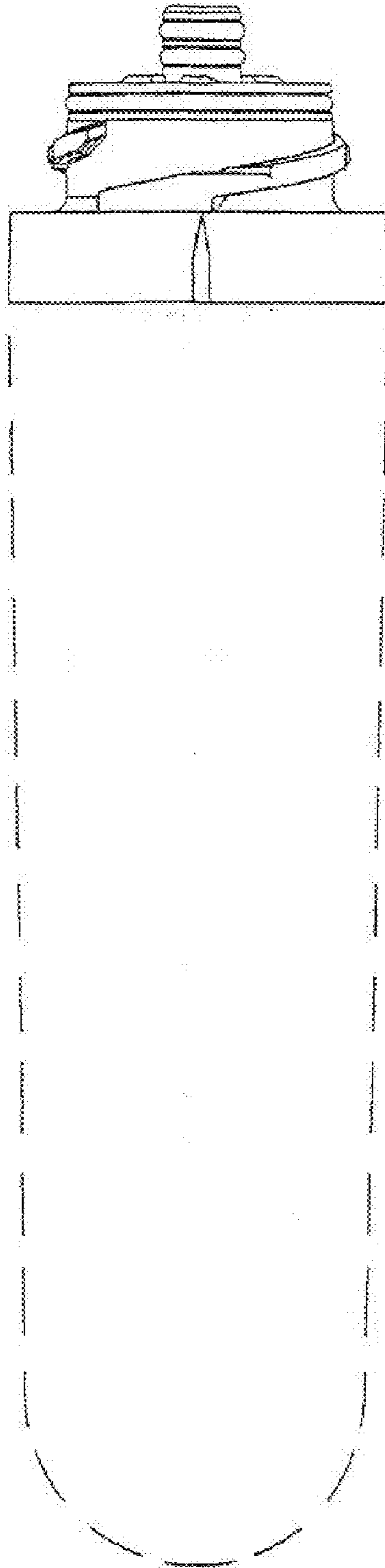

FIGURE 2

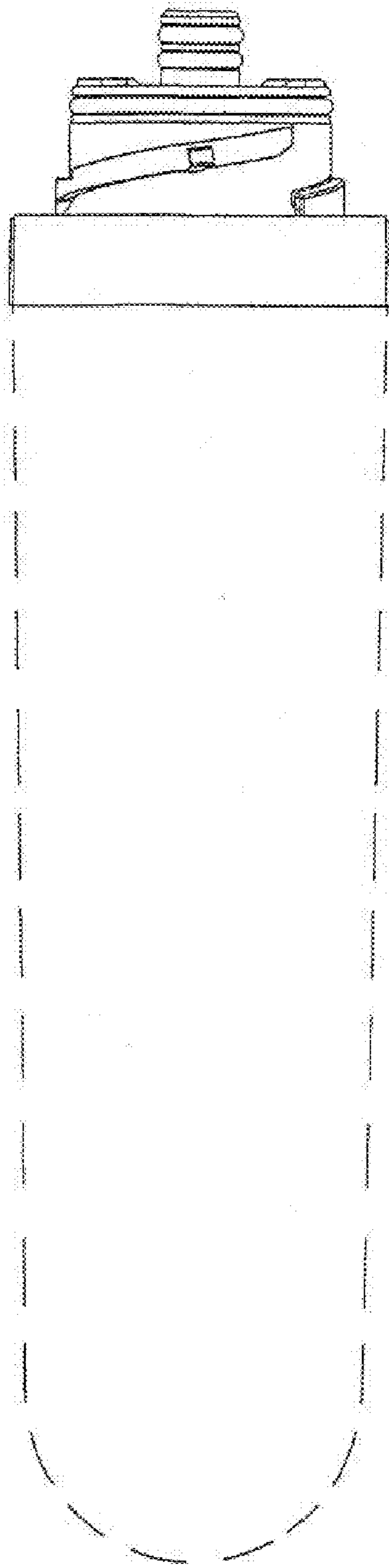

FIGURE 3

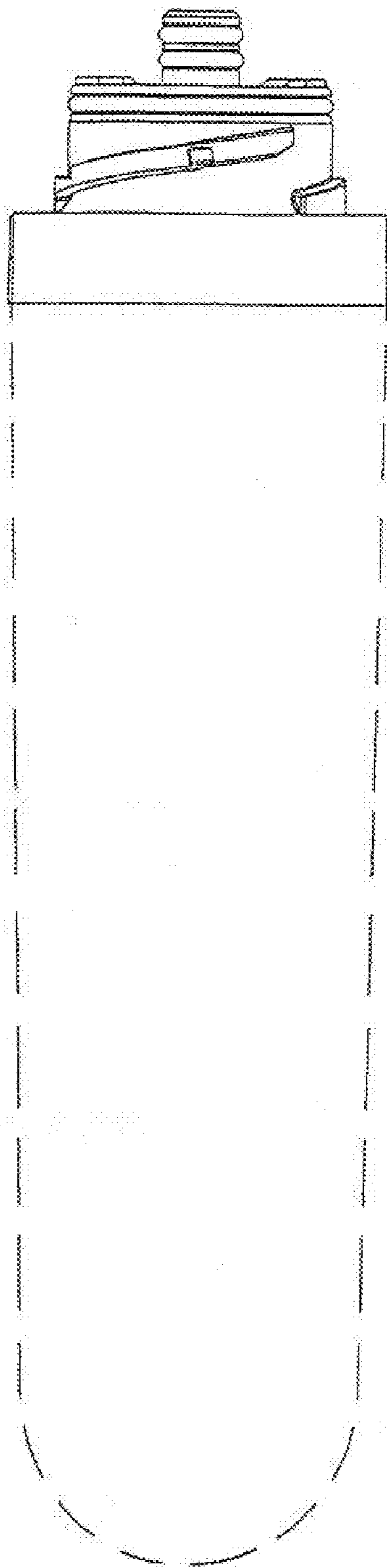

FIGURE 4

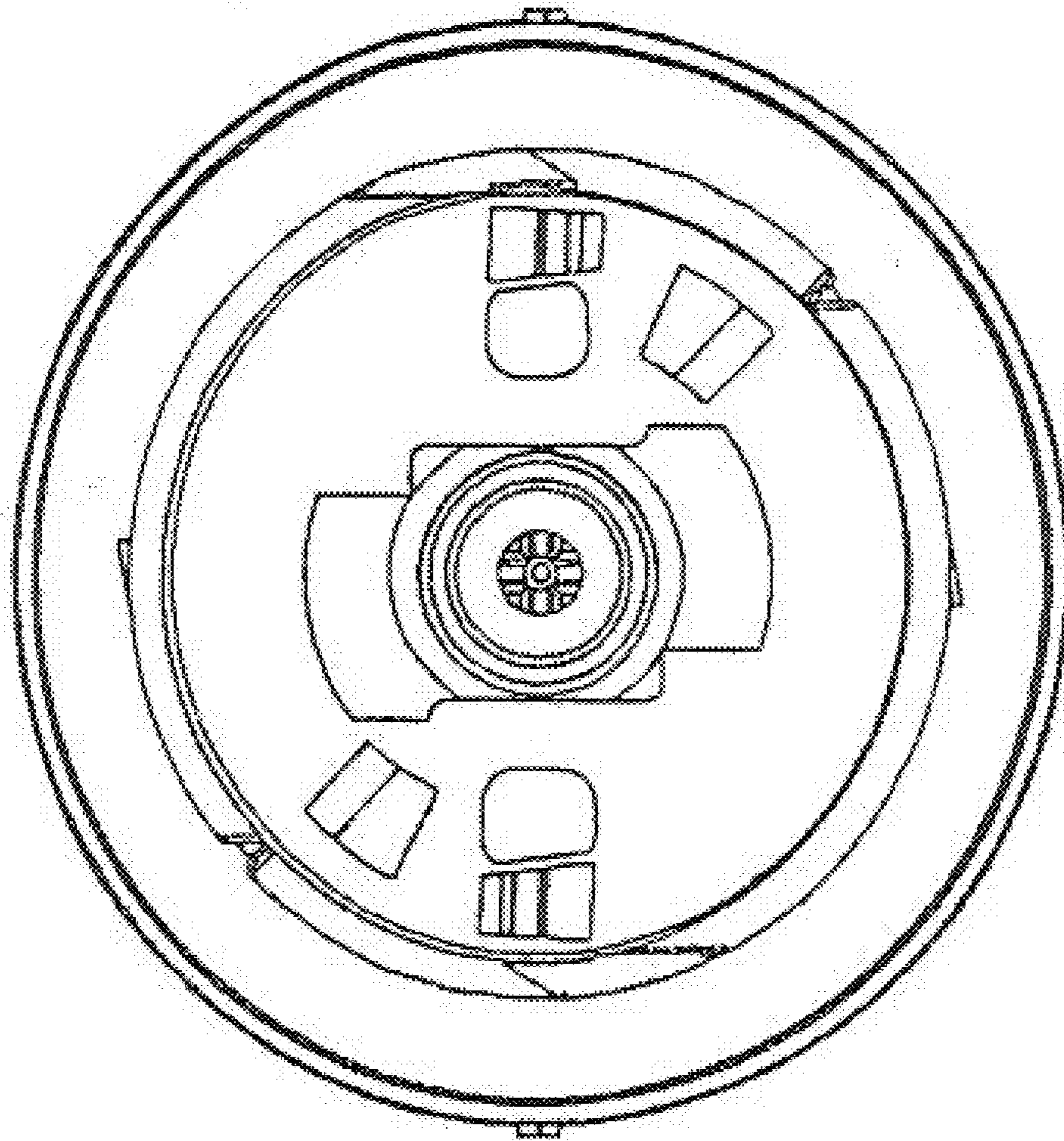

FIGURE 5

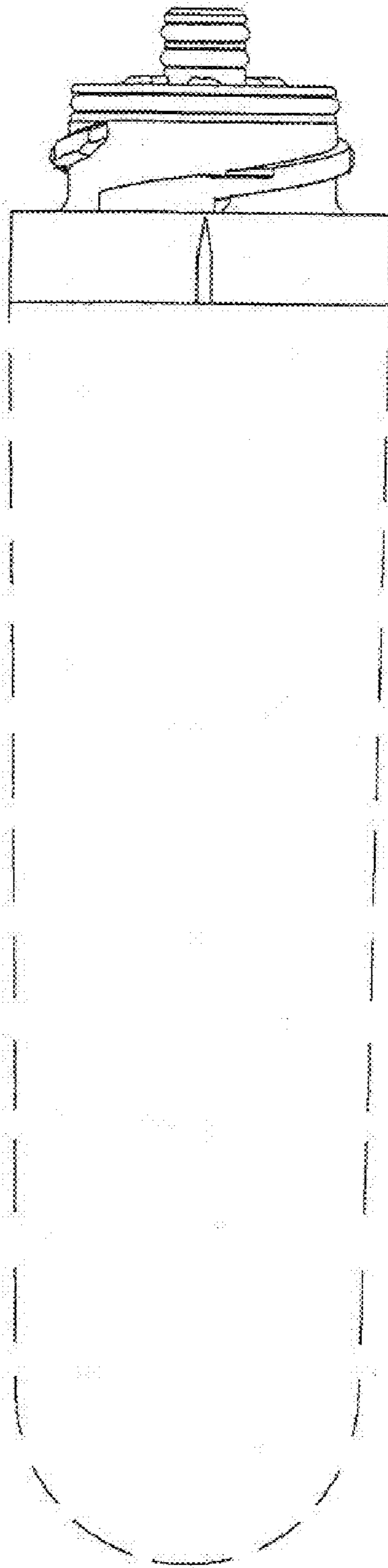

FIGURE 6

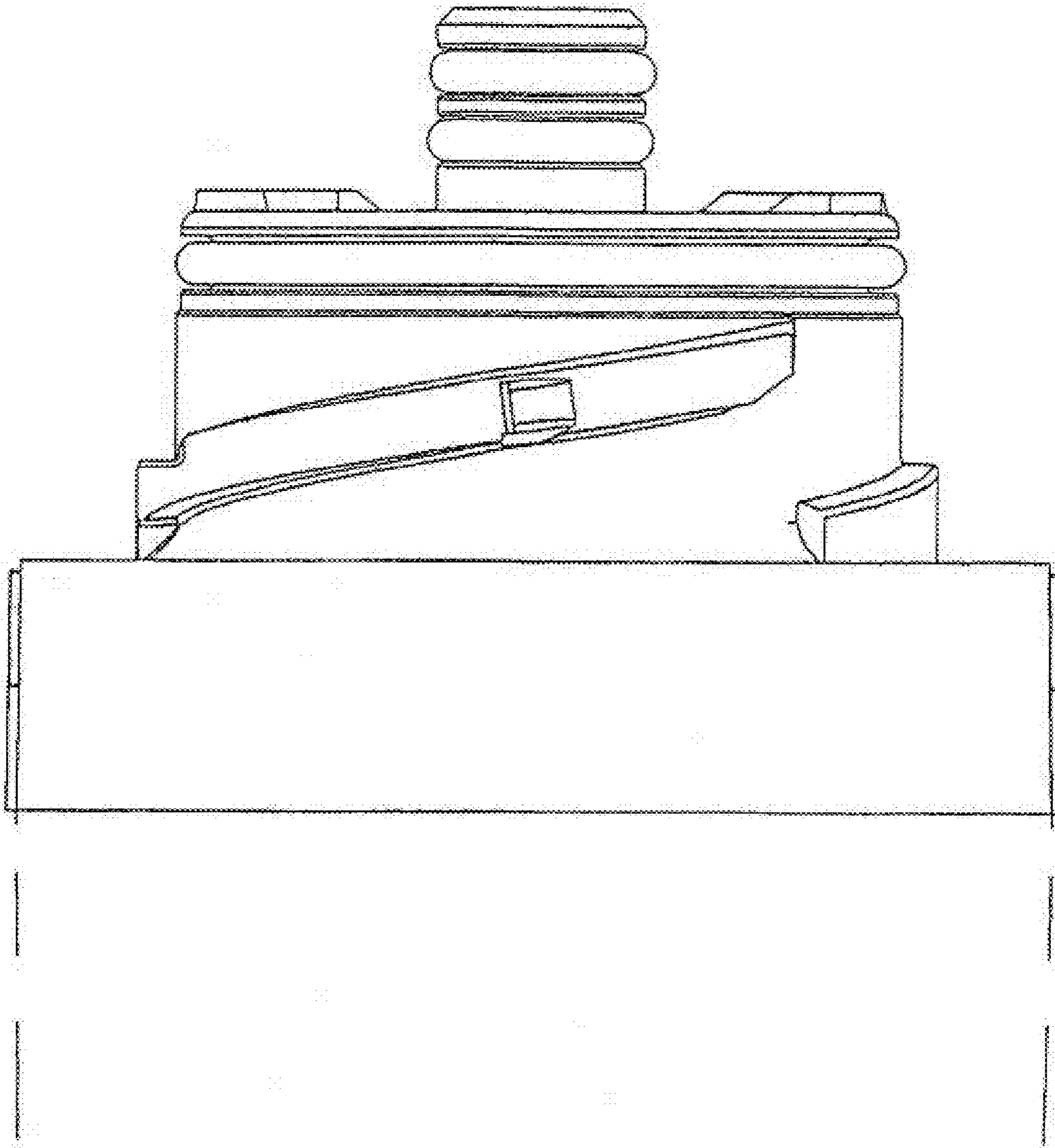

FIGURE 7