

US00D599872S

(12) **United States Design Patent**
Camiscioli

(10) **Patent No.:** **US D599,872 S**

(45) **Date of Patent:** **** Sep. 8, 2009**

(54) **WALKING STAND FOR A CHILD**

D493,504 S * 7/2004 Byrd et al. D21/827
D496,088 S * 9/2004 Byrd D21/827

(76) Inventor: **Mark Camiscioli**, 41 Seville Dr., Brick,
NJ (US) 08723

* cited by examiner

(**) Term: **14 Years**

Primary Examiner—Mitchell I Siegel
(74) *Attorney, Agent, or Firm*—Sperry, Zoda & Kane

(21) Appl. No.: **29/312,931**

(57) **CLAIM**

(22) Filed: **Nov. 24, 2008**

The ornamental design for a walking stand for a child, as shown.

(51) **LOC (9) Cl.** **21-03**

(52) **U.S. Cl.** **D21/826**

(58) **Field of Classification Search** D21/811,
D21/814, 826–827; 482/35–36

See application file for complete search history.

DESCRIPTION

FIG. 1 is a front three-quarter perspective from above embodying my new design;

FIG. 2 is a side view from below;

FIG. 3 is a side view from the left in FIG. 1;

FIG. 4 is a side view from the right in FIG. 1;

FIG. 5 is a rear plan view;

FIG. 6 is a top plan view; and,

FIG. 7 is a bottom plan view.

(56) **References Cited**

U.S. PATENT DOCUMENTS

D336,503 S *	6/1993	Hernandez, Jr.	D21/830
D340,274 S *	10/1993	Gleeson et al.	D21/826
D363,522 S *	10/1995	Erlick	D21/827
D363,523 S *	10/1995	Erlick	D21/827
D370,708 S *	6/1996	Erlick	D21/827
D370,957 S *	6/1996	Erlick	D21/827

1 Claim, 6 Drawing Sheets

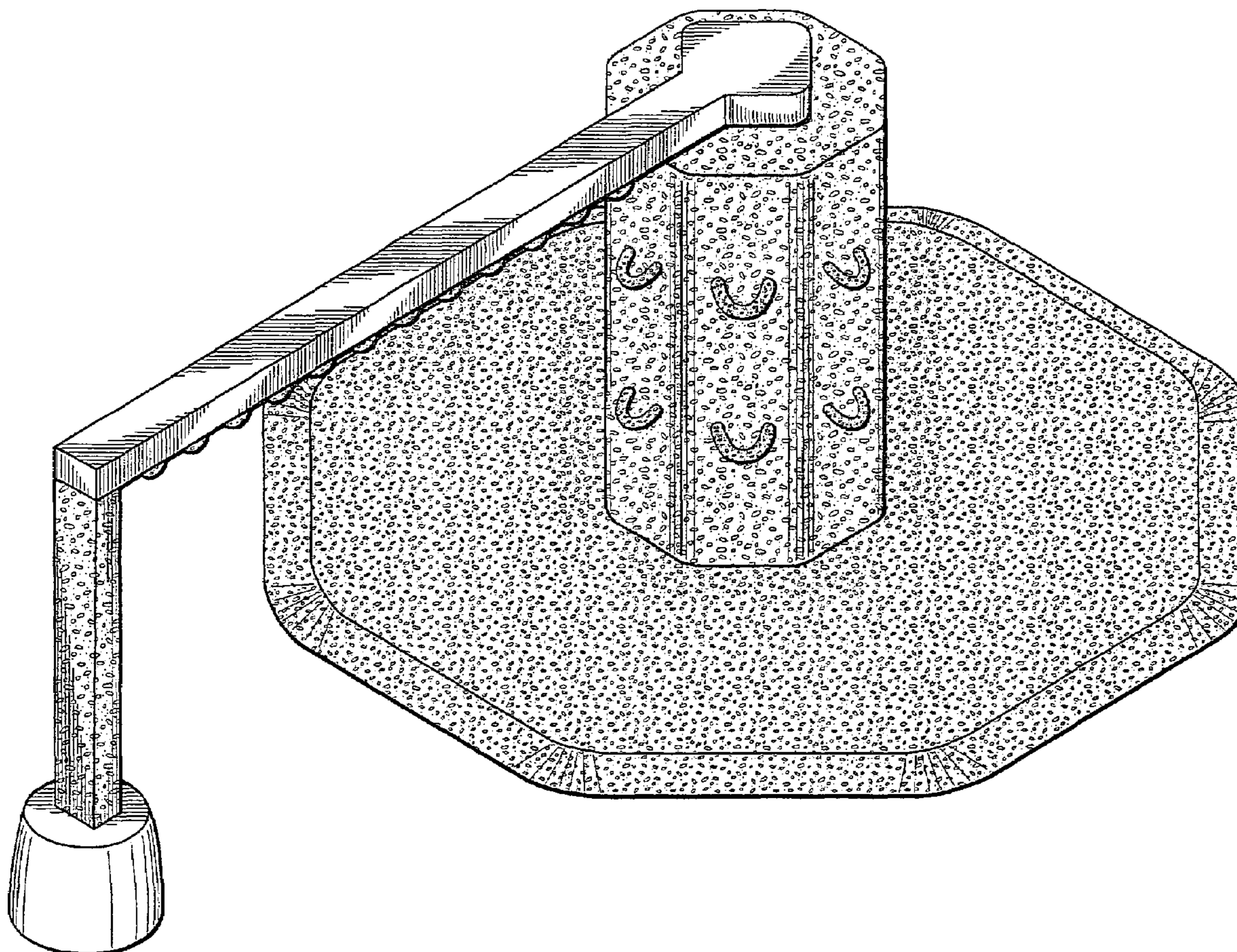

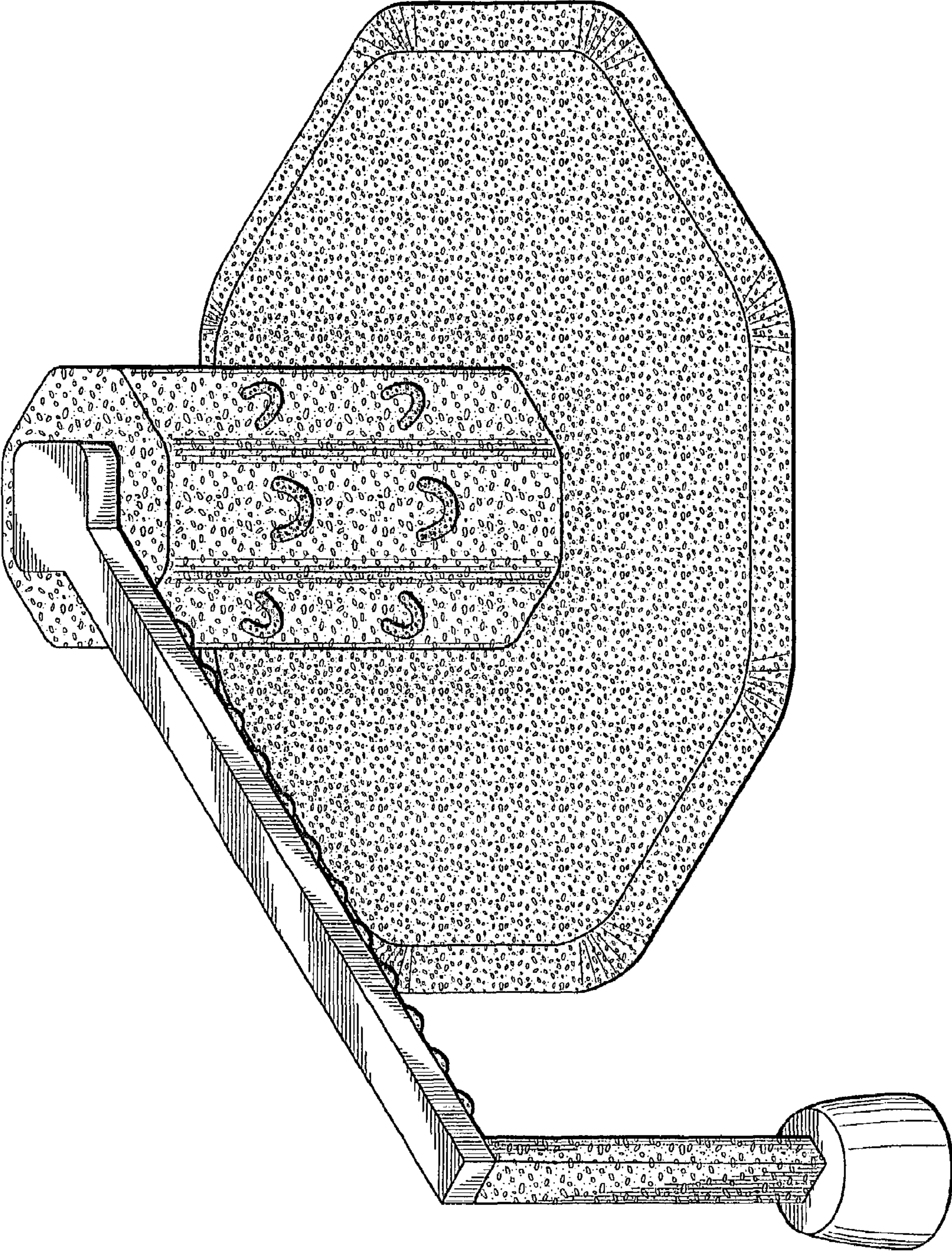

FIG. 1

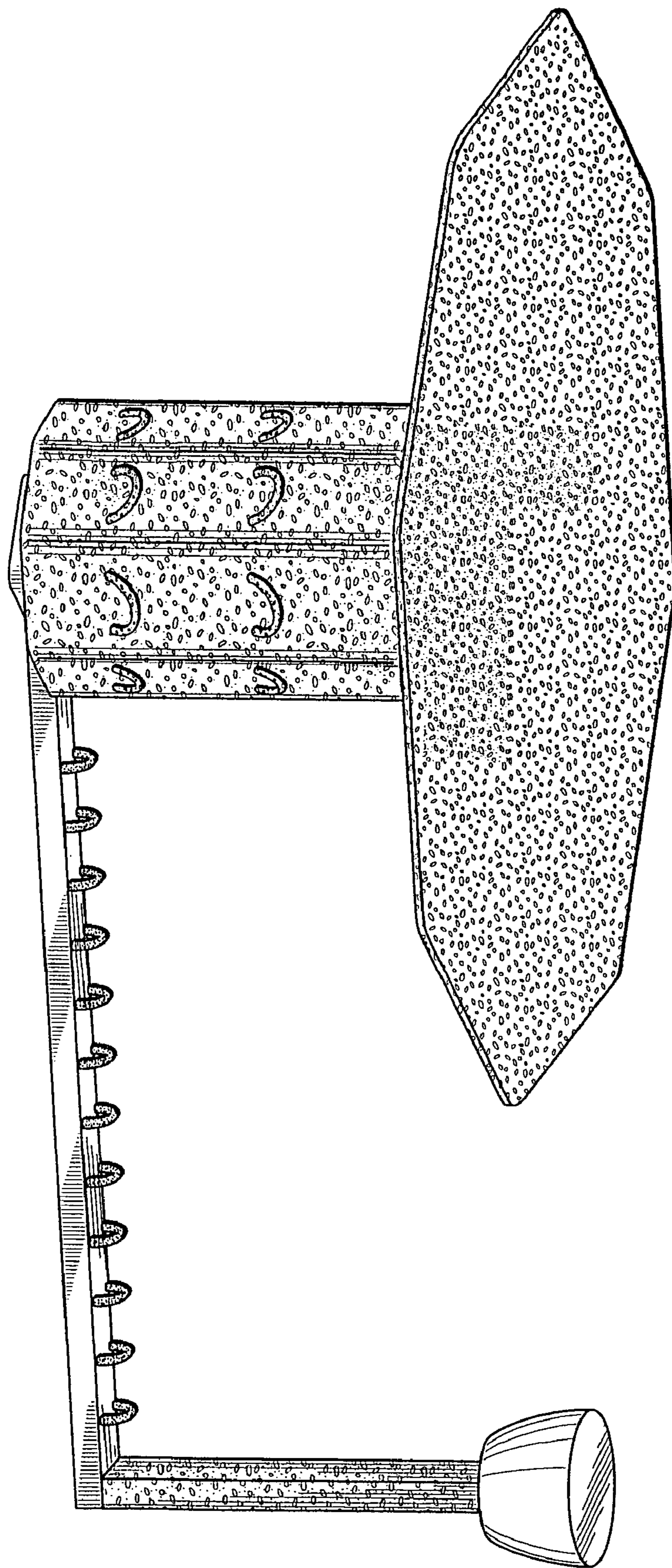

FIG. 2

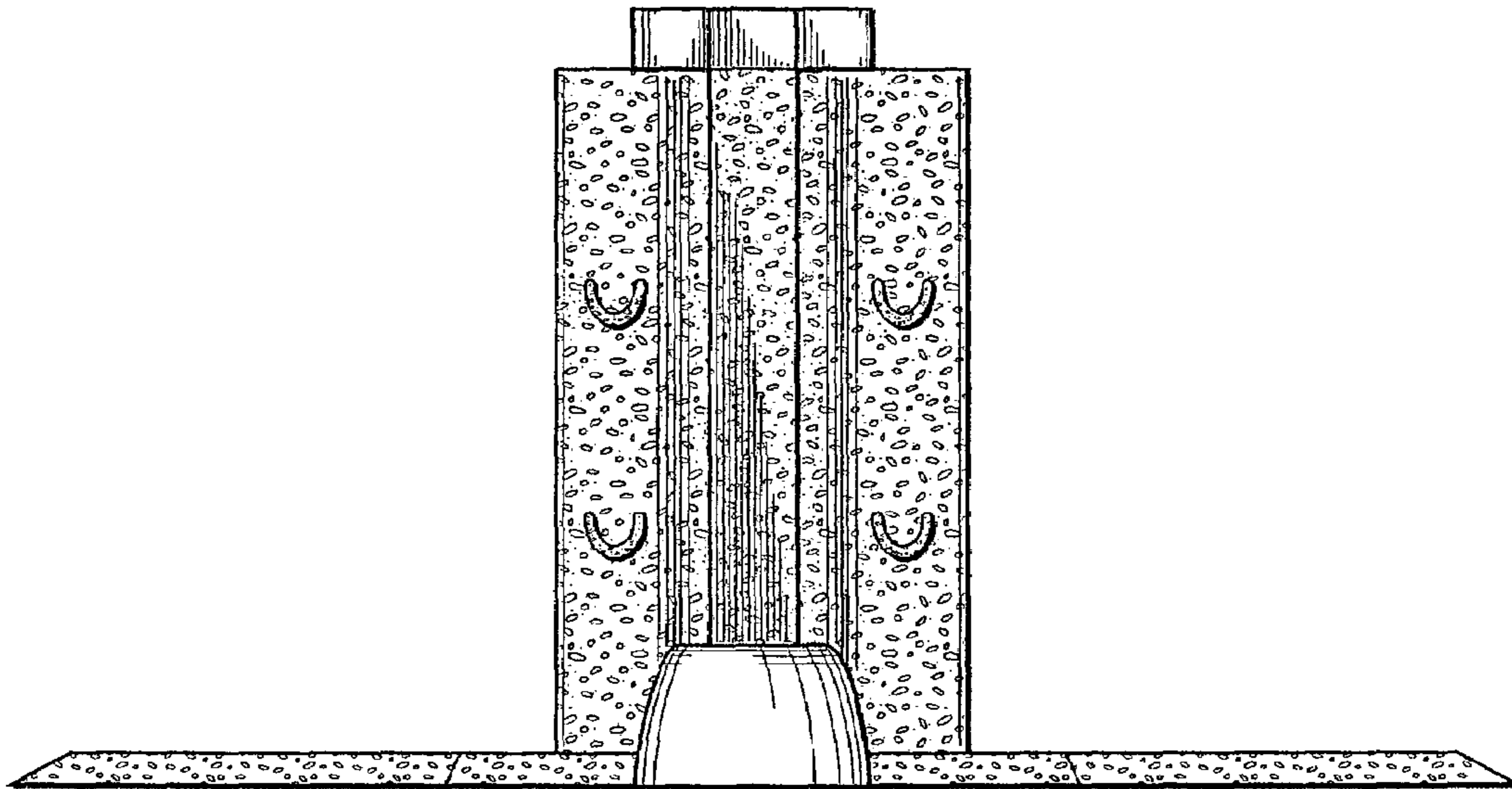

FIG. 3

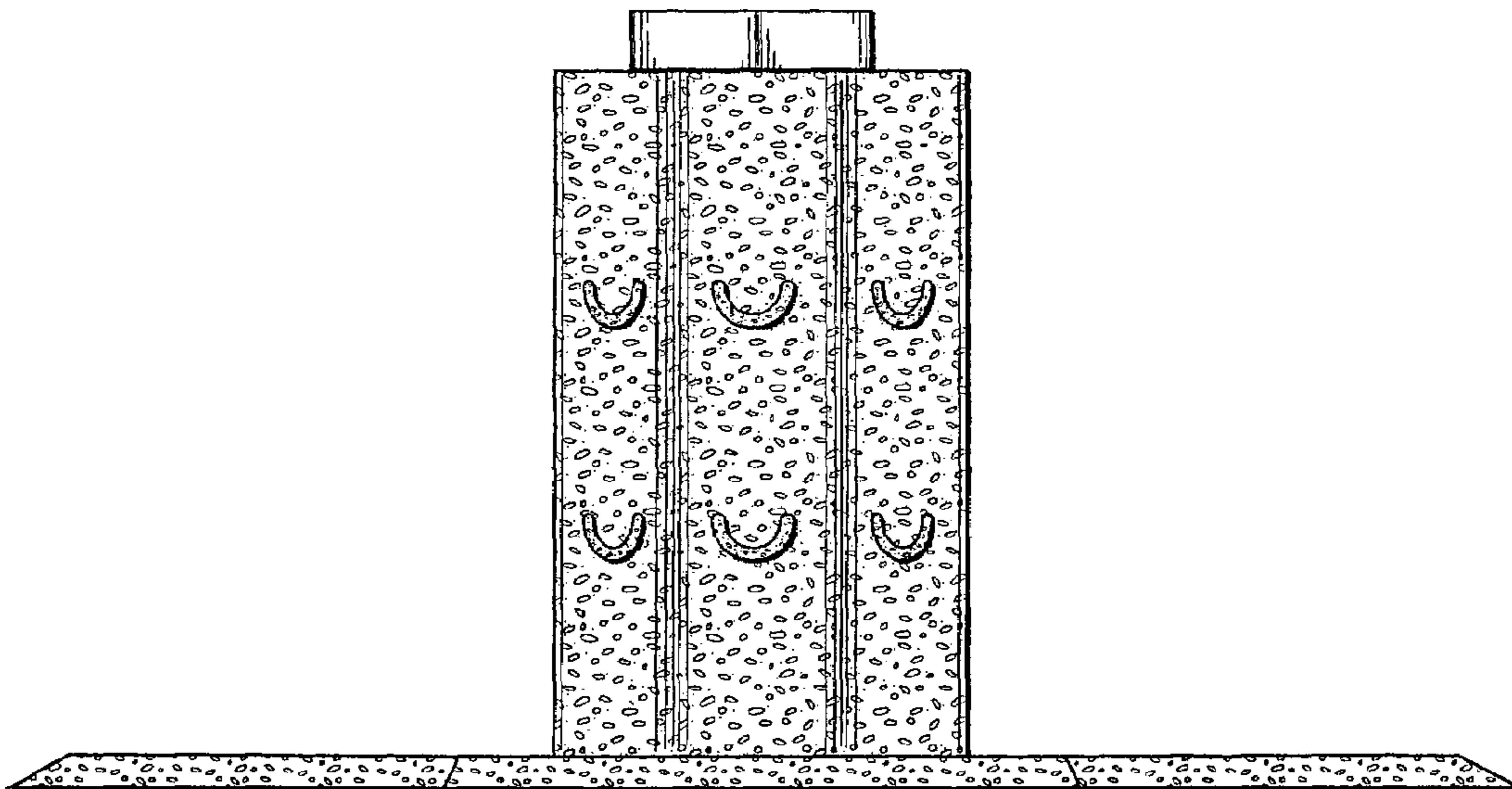

FIG. 4

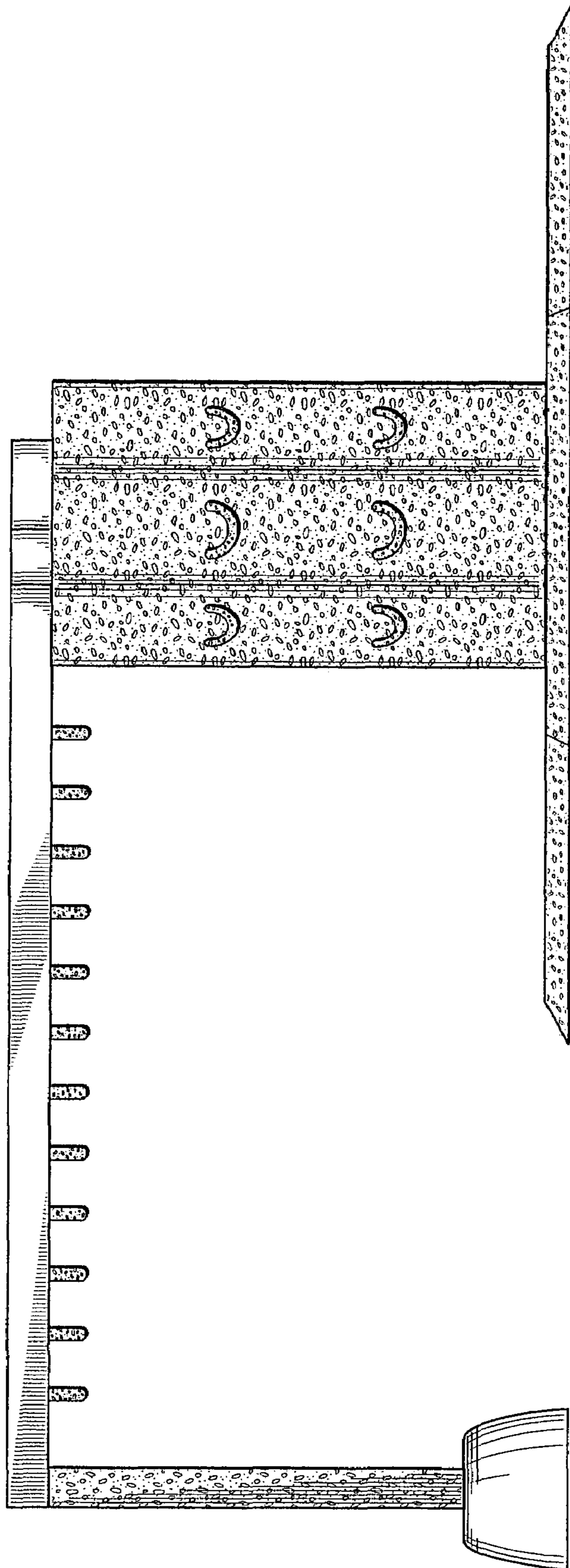

FIG. 5

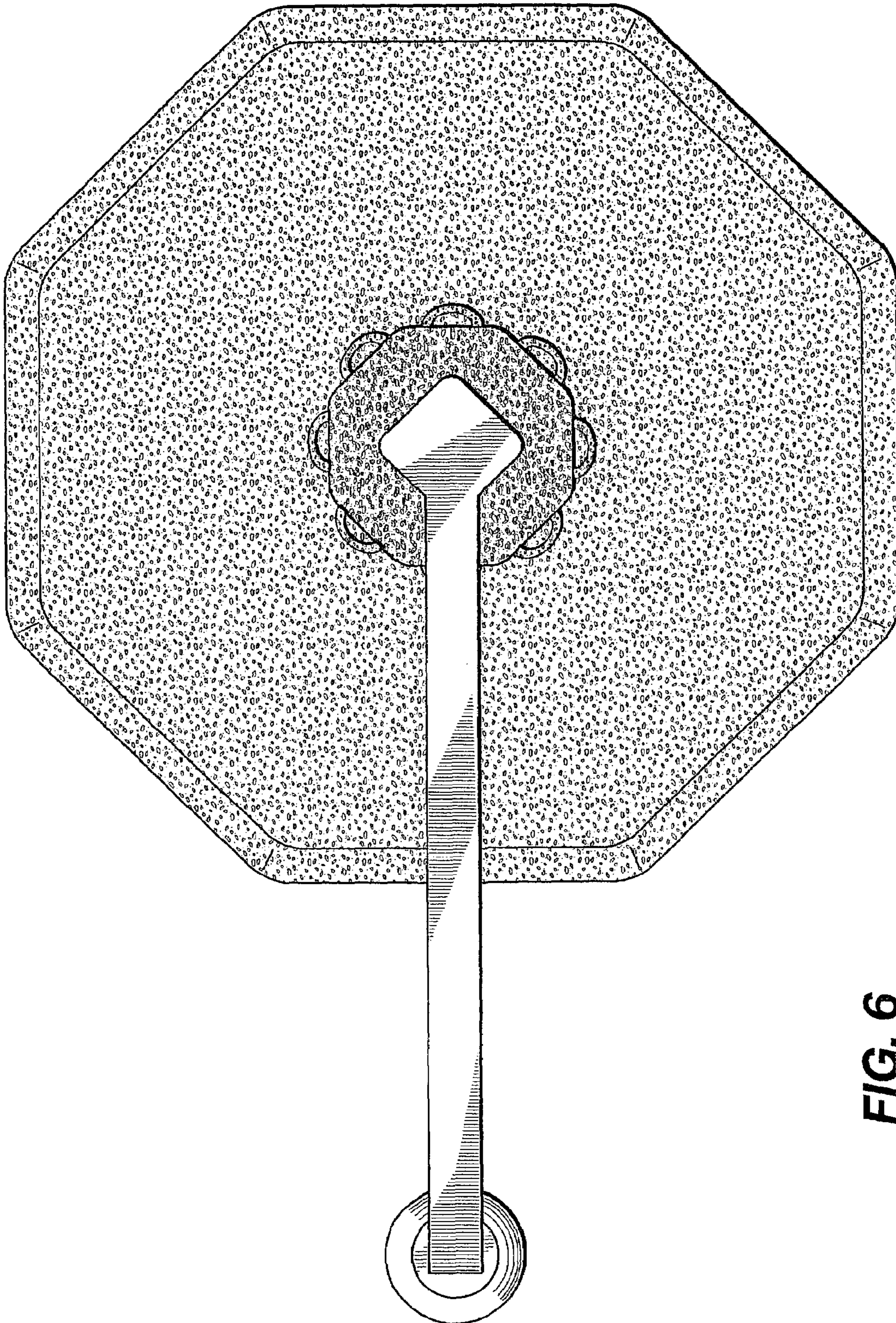

FIG. 6

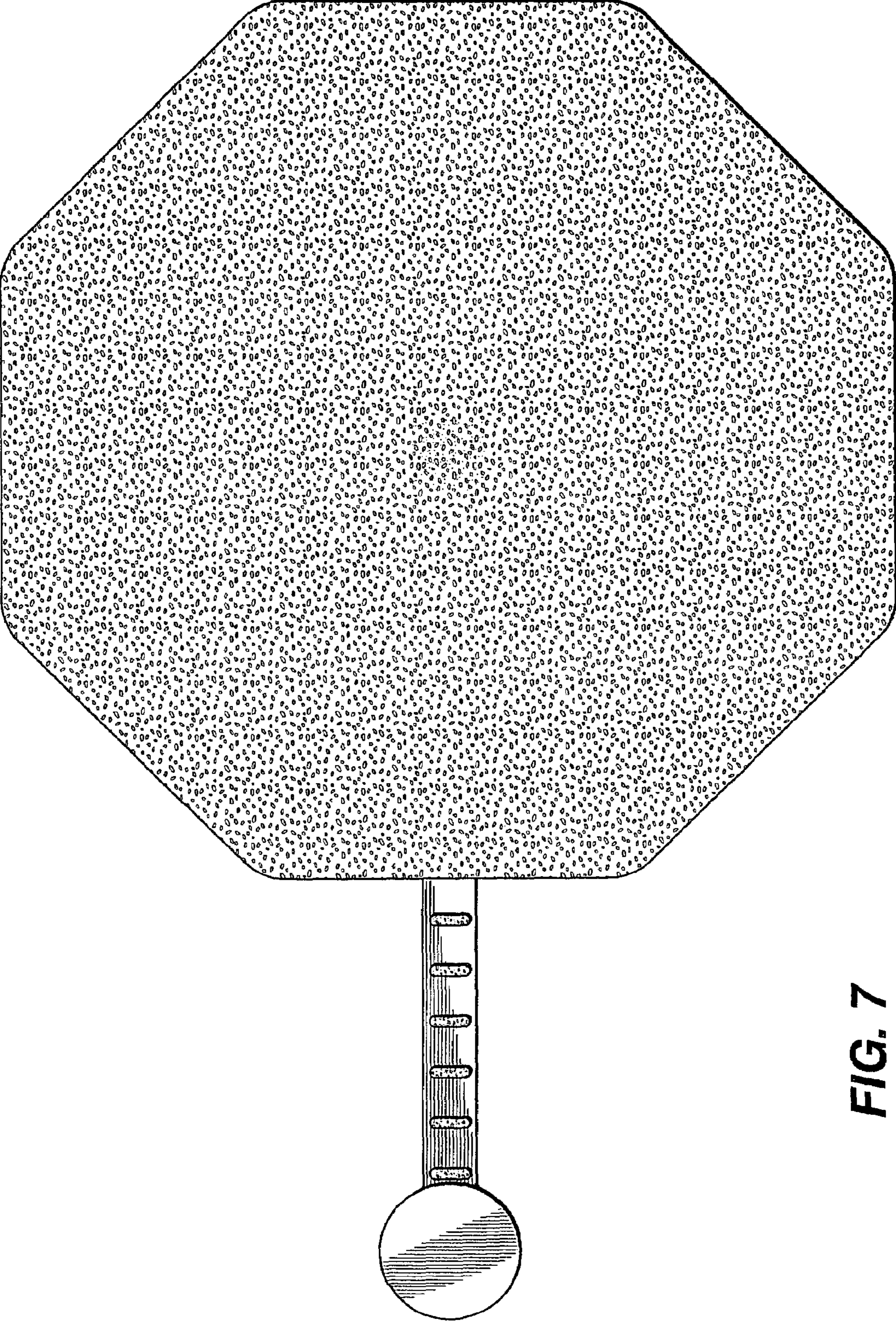

FIG. 7