



US00D599769S

(12) **United States Design Patent**
Chambers

(10) **Patent No.:** **US D599,769 S**

(45) **Date of Patent:** **** *Sep. 8, 2009**

(54) **PORTABLE PHONE**

(75) Inventor: **Susanne Chambers**, Rancho Dominguez, CA (US)

(73) Assignee: **Samsung Electronics Co., Ltd.**, Suwon-Si (KR)

(*) Notice: This patent is subject to a terminal disclaimer.

(**) Term: **14 Years**

(21) Appl. No.: **29/324,893**

(22) Filed: **Sep. 23, 2008**

(30) **Foreign Application Priority Data**

Aug. 8, 2008 (KR) 30-2008-0034569

(51) **LOC (9) Cl.** **14-03**

(52) **U.S. Cl.** **D14/138 AB**

(58) **Field of Classification Search** D14/138 AB,
D14/496, 341-347; 455/575.3
See application file for complete search history.

(56) **References Cited**

U.S. PATENT DOCUMENTS

D496,016 S *	9/2004	Hoo	D14/138 AB
D508,035 S *	8/2005	Kim et al.	D14/138 AB
D519,966 S *	5/2006	Salmi et al.	D14/138 AB
D537,059 S *	2/2007	Hwang	D14/138 AB
D549,680 S *	8/2007	Lee et al.	D14/138 AB
D557,230 S *	12/2007	Kim et al.	D14/138 AB
D560,186 S *	1/2008	Kim et al.	D14/138 AB
D560,189 S *	1/2008	Kim et al.	D14/138 AB
D563,924 S *	3/2008	Arnold et al.	D14/138 AB
D571,345 S *	6/2008	Kim et al.	D14/138
D571,772 S *	6/2008	Kim et al.	D14/138
D571,773 S *	6/2008	Kim et al.	D14/138
D572,226 S *	7/2008	Park et al.	D14/138
D572,690 S *	7/2008	Kim et al.	D14/138

(Continued)

OTHER PUBLICATIONS

Samsung E210 telephone, announced Aug. 2007, [online], [site visited Dec. 19, 2008]. Available from Internet ,<URL: http://www.gsmarena.com>.*

Nokia 6085 telephone, announced Sep. 2006, [online], [site visited Dec. 19, 2008]. Available from Internet ,<URL: http://www.gsmarena.com>.*

Nokia 6170 telephone, announced 3rd quarter 2004, [online], [site visited Dec. 19, 2008]. Available from Internet ,<URL: http://www.gsmarena.com>.*

LG KP210 telephone, announced Feb. 2008, [online], [site visited Dec. 19, 2008]. Available from Internet ,<URL: http://www.gsmarena.com>.*

LG Trax CU575 telephone, announced Aug. 2007, [online], [site visited Dec. 19, 2008]. Available from Internet ,<URL: http://www.gsmarena.com>.*

BenQ-Siemens A53 telephone, announced Apr. 2007, [online], [site visited Dec. 19, 2008]. Available from Internet ,<URL: http://www.gsmarena.com>.*

Pantech PG-2800 telephone, announced May 2006, [online], [site visited Dec. 19, 2008]. Available from Internet ,<URL: http://www.gsmarena.com>.*

Haier M1100 telephone, announced 2005, [online], [site visited Dec. 19, 2008]. Available from Internet ,<URL: http://www.gsmarena.com>.*

Primary Examiner—Jeffrey D Asch

(74) *Attorney, Agent, or Firm*—Staas & Halsey LLP

(57) **CLAIM**

The ornamental design for a portable phone, as shown and described.

DESCRIPTION

FIG. 1 is a perspective view of a portable phone;
FIG. 2 is a front view of the portable phone of FIG. 1;
FIG. 3 is a rear view of the portable phone of FIG. 1;
FIG. 4 is a left-side view of the portable phone of FIG. 1;
FIG. 5 is a right-side view of the portable phone of FIG. 1;
FIG. 6 is a top plan view of the portable phone of FIG. 1;
FIG. 7 is a bottom plan view of the portable phone of FIG. 1;
and,
FIG. 8 is a front open view of the portable phone of FIG. 1.

1 Claim, 5 Drawing Sheets

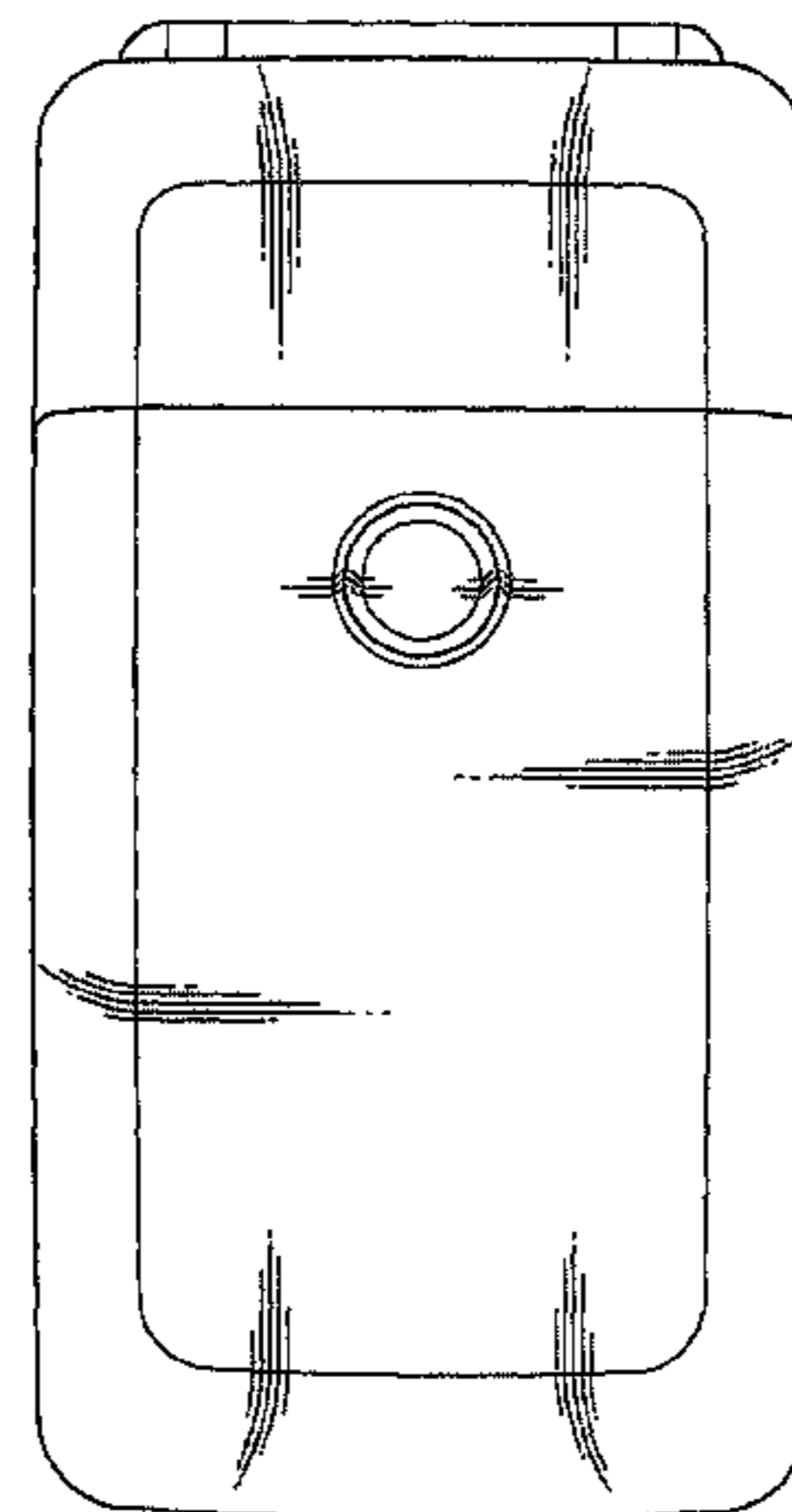
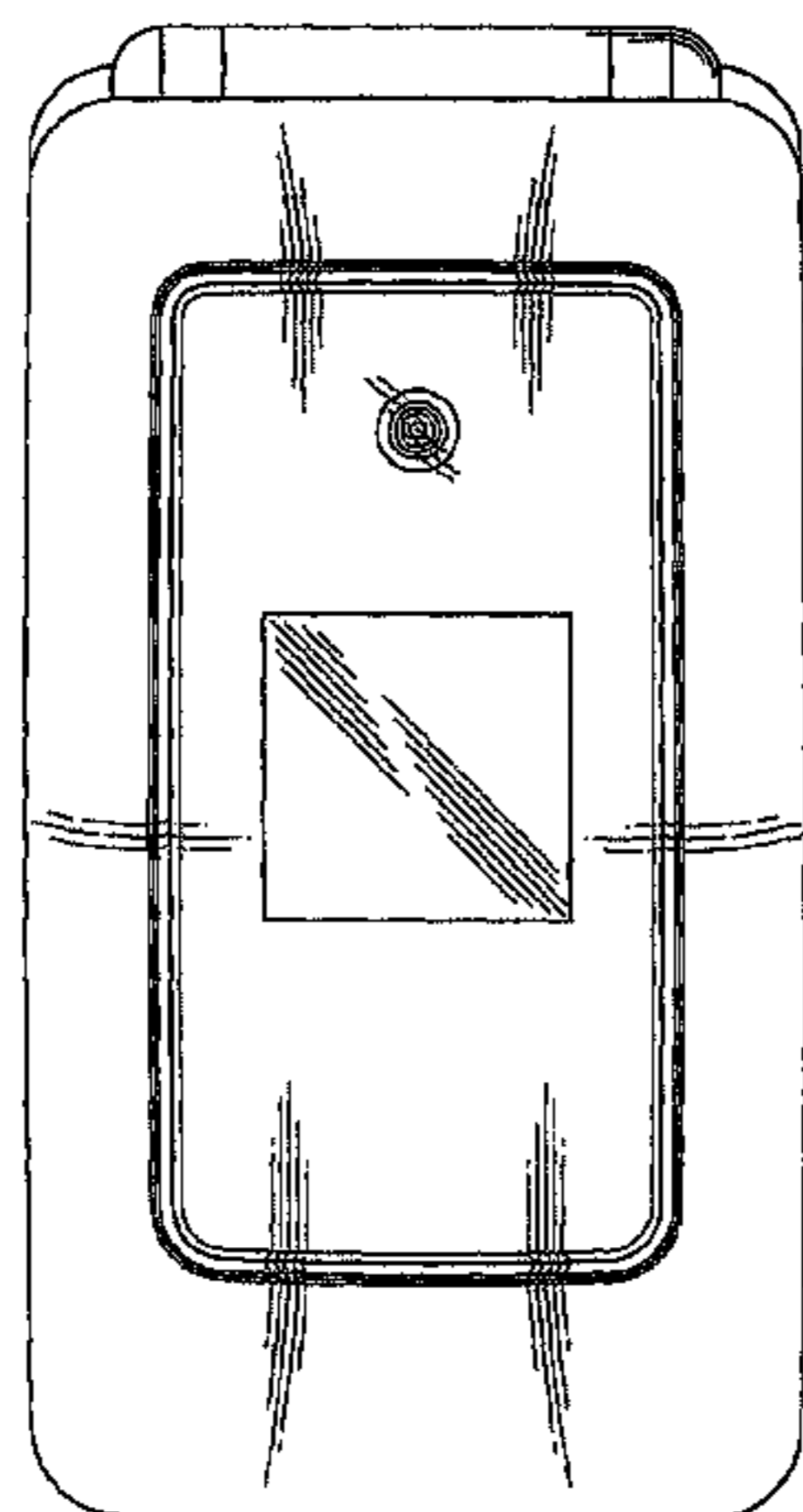

US D599,769 S

Page 2

U.S. PATENT DOCUMENTS

D573,124 S *	7/2008	Han et al.	D14/138	D579,432 S *	10/2008	Kim et al.	D14/138 R
D573,127 S *	7/2008	Choi et al.	D14/138	D580,402 S *	11/2008	Lee et al.	D14/138 AB
D573,575 S *	7/2008	Song et al.	D14/138	D582,381 S *	12/2008	Hong et al.	D14/138 AB
D574,803 S *	8/2008	Oh et al.	D14/138	D582,877 S *	12/2008	Lee et al.	D14/138 AB
D577,702 S *	9/2008	Hakamaki et al.	D14/138 AB	D582,879 S *	12/2008	Chung et al.	D14/138 R
D578,092 S *	10/2008	Lee	D14/138 AB	D582,883 S *	12/2008	Koh et al.	D14/138 R

* cited by examiner

FIG. 1

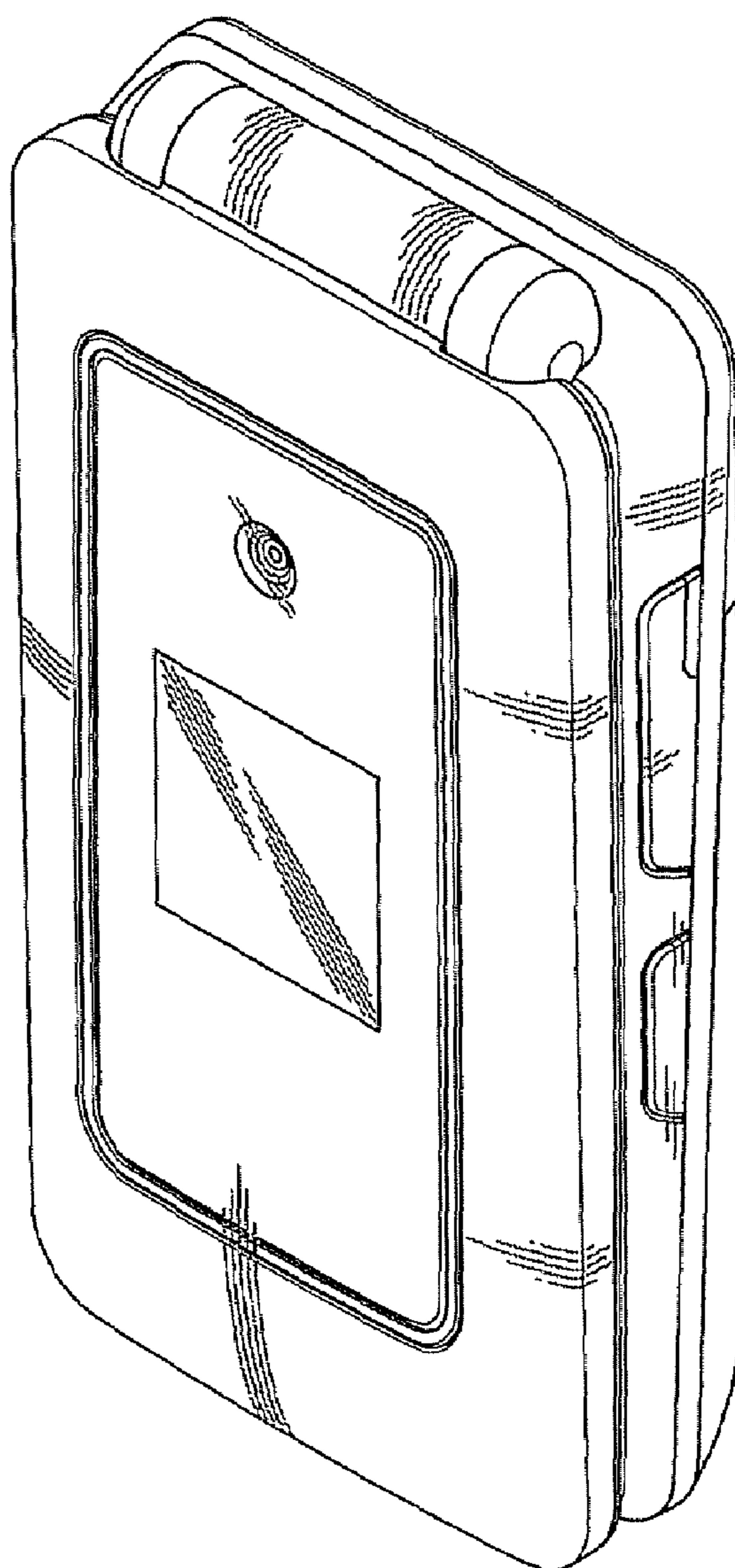

FIG. 2

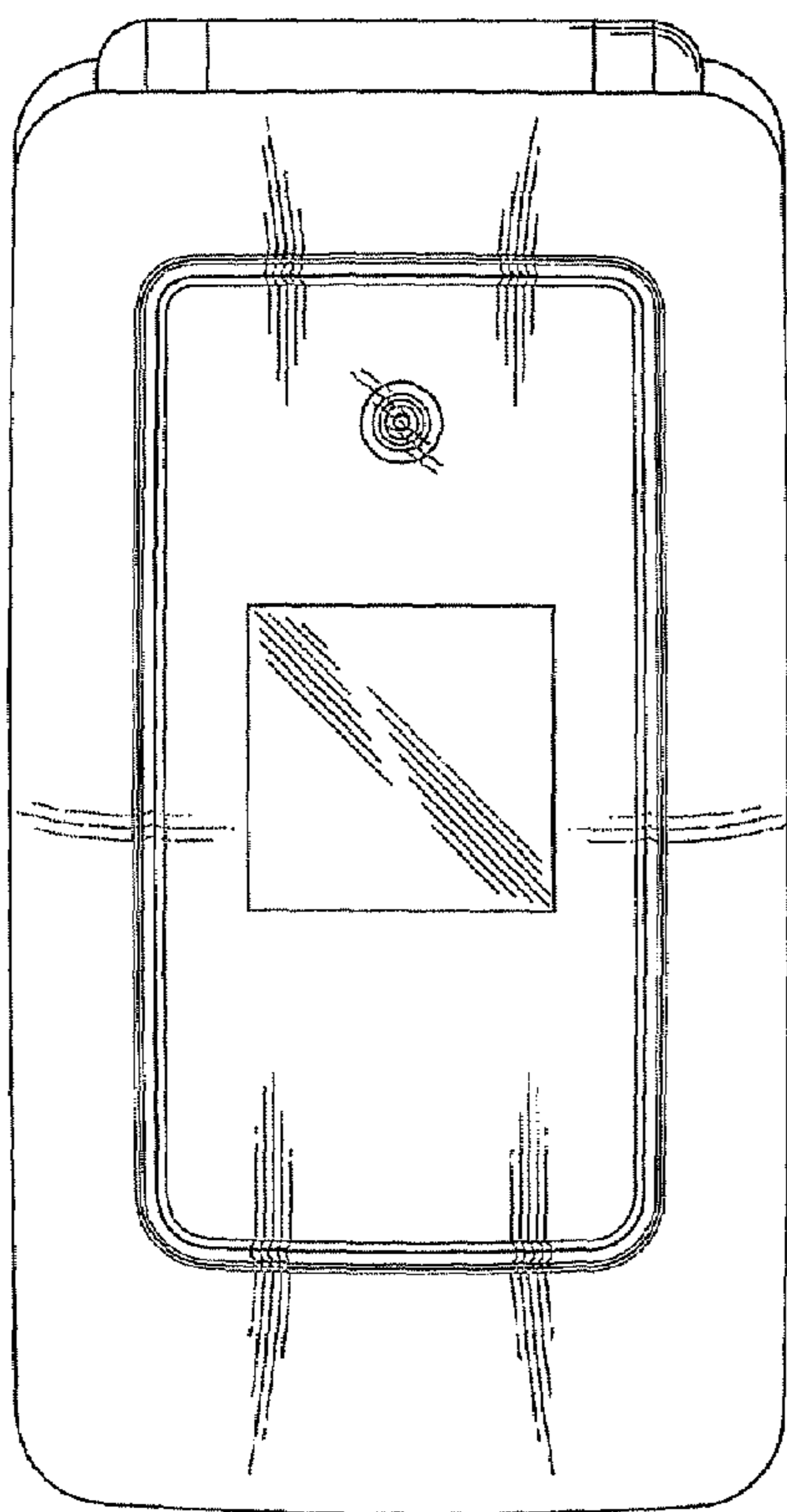

FIG. 3

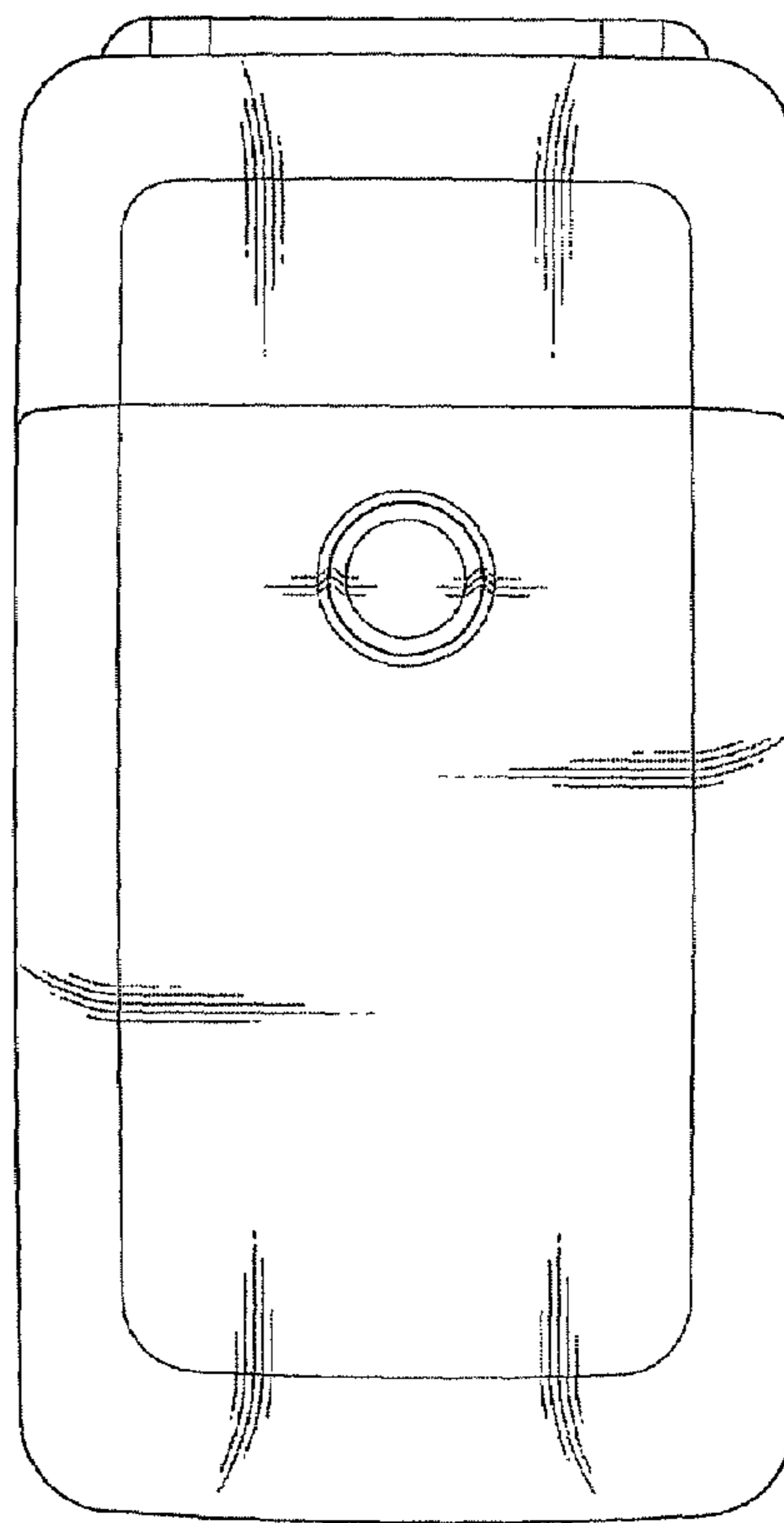

FIG. 4

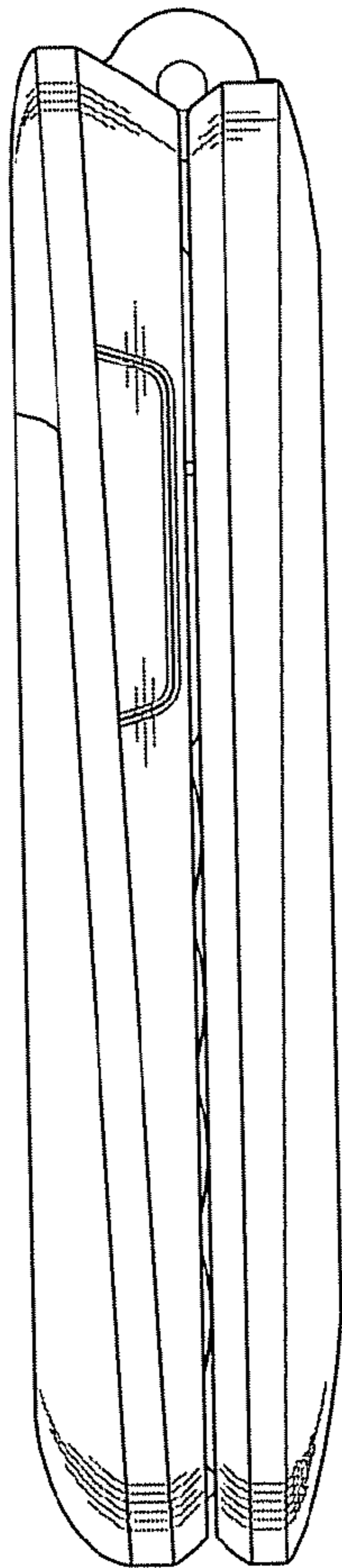

FIG. 5

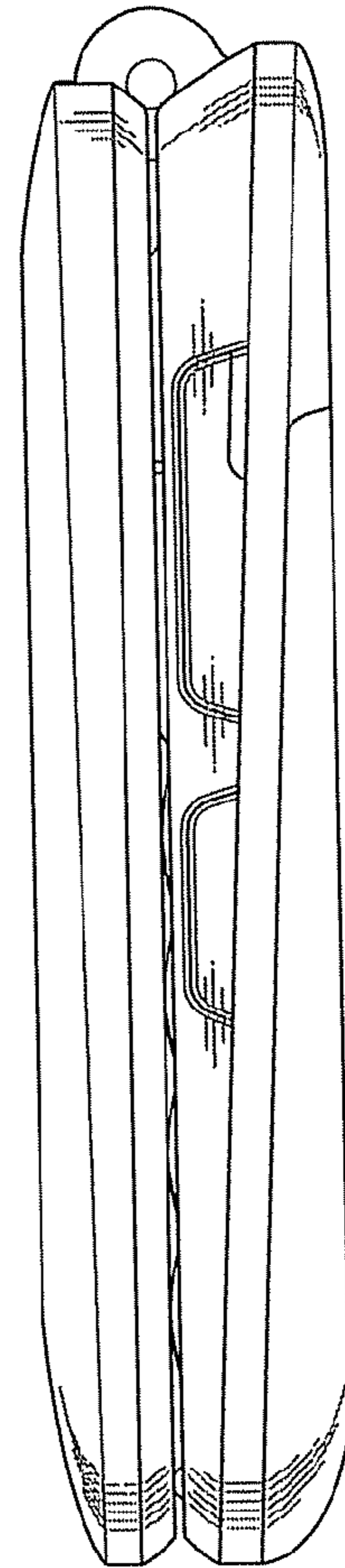

FIG. 6

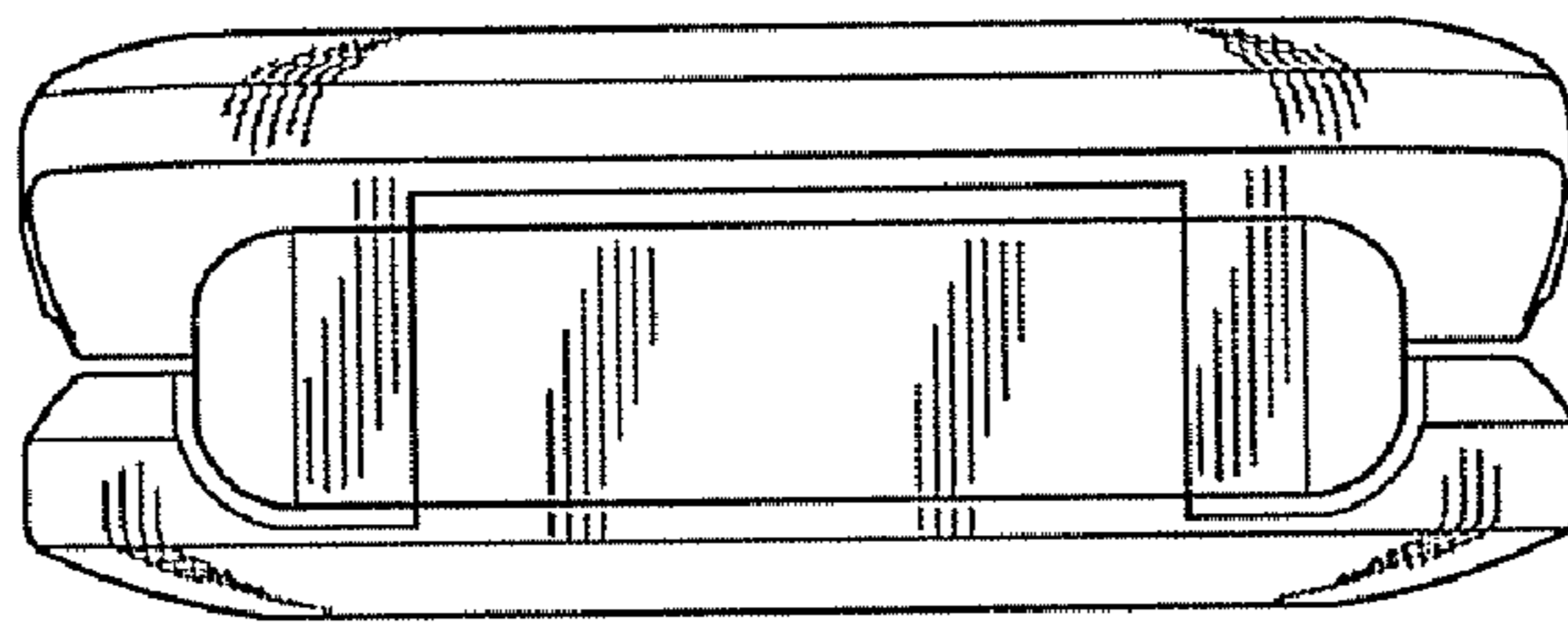

FIG. 7

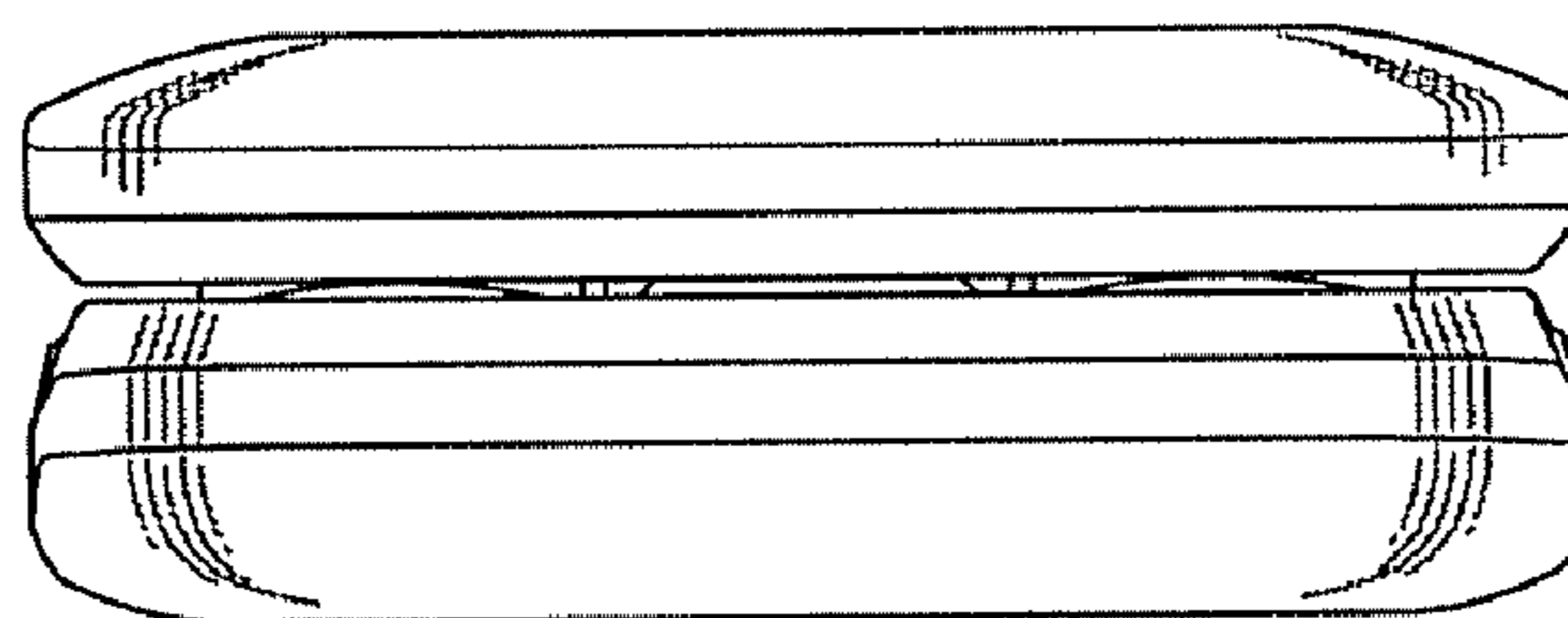

FIG. 8

