



US00D599768S

(12) **United States Design Patent**
Kim et al.

(10) **Patent No.:** **US D599,768 S**
(45) **Date of Patent:** **** Sep. 8, 2009**

(54) **MOBILE PHONE**

D545,802 S * 7/2007 Choi et al. D14/138 AC
D554,091 S * 10/2007 Chauhan et al. D14/138 AC

(75) Inventors: **Bo-Ra Kim**, Seoul (KR); **Sang-Min Hyun**, Seoul (KR); **Seog-Guen Kim**, Seoul (KR); **Chang-Hwan Hwang**, Goyang-si (KR)

(Continued)

(73) Assignee: **Samsung Electronics Co., Ltd.**, Suwon-Si (KR)

OTHER PUBLICATIONS

(**) Term: **14 Years**

Sagem MY C-4, announced 3rd quarter 2004, [online], [retrieved on Feb. 20, 2007]. Retrieved from Internet ,<URL: http://www.gsmarena.com>.*

(21) Appl. No.: **29/324,827**

Samsung X810, announced 2nd quarter 2005, [online], [retrieved on Aug. 21, 2007]. Retrieved from Internet ,<URL: http://www.gsmarena.com>.*

(22) Filed: **Sep. 22, 2008**

Samsung F210, announced Jun. 2007, [online], [retrieved on Aug. 6, 2007]. Retrieved from Internet ,<URL: http://www.gsmarena.com>.*

(30) **Foreign Application Priority Data**

Samsung Serenata, announced Oct. 2007, [online], [retrieved on Dec. 13, 2007]. Retrieved from Internet ,<URL: http://www.gsmarena.com>.*

May 19, 2008 (KR) 30-2008-0020968

Samsung M6710 Beat Disc, announced Feb. 2009, [online], [retrieved on Feb. 20, 2009]. Retrieved from Internet ,<URL: http://www.gsmarena.com>.*

(51) **LOC (9) Cl.** **14-03**

(52) **U.S. Cl.** **D14/138 AD**

(58) **Field of Classification Search** D14/138 R, D14/138 AD, 138 AC, 138 C, 138 G, 191, D14/203.1–203.8, 496, 138 AA, 138 AB, D14/247–248, 137, 147, 218, 341–347; D10/65, D10/78, 104; D13/168; D18/7; 455/566, 455/575.1, 575.3

Primary Examiner—Jeffrey D Asch

Assistant Examiner—Bridget L Eland

(74) *Attorney, Agent, or Firm*—Staas & Halsey LLP

See application file for complete search history.

(57) **CLAIM**

The ornamental design for a mobile phone, as shown and described.

(56) **References Cited**

DESCRIPTION

U.S. PATENT DOCUMENTS

- D261,274 S * 10/1981 Gobeli D18/7
- 5,259,019 A * 11/1993 Stilley 455/575.3
- D346,152 S * 4/1994 Zaugg D13/168
- D480,697 S * 10/2003 Lee et al. D14/138 AC
- D486,806 S * 2/2004 Takayama et al. D14/137
- D486,807 S * 2/2004 Takayama et al. D14/137
- D500,499 S * 1/2005 Pitt et al. D14/248
- D508,687 S * 8/2005 Lee D14/138 AD
- 7,003,104 B2 * 2/2006 Lee 379/433.13
- D530,300 S * 10/2006 Cha et al. D14/138 AD
- D530,301 S * 10/2006 Kim et al. D14/138 AD
- D542,766 S * 5/2007 Miyazaki et al. D14/138 AC
- D542,767 S * 5/2007 Choi et al. D14/138 AC

FIG. 1 is a front perspective view of a mobile phone;
FIG. 2 is a front view of the mobile phone of FIG. 1;
FIG. 3 is a rear view of the mobile phone of FIG. 1;
FIG. 4 is a left-side view of the mobile phone of FIG. 1;
FIG. 5 is a right-side view of the mobile phone of FIG. 1;
FIG. 6 is a top plan view of the mobile phone of FIG. 1;
FIG. 7 is a bottom plan view of the mobile phone of FIG. 1;
and,
FIG. 8 is a front open view, with the front panel slid up, of the mobile phone of FIG. 1.

1 Claim, 6 Drawing Sheets

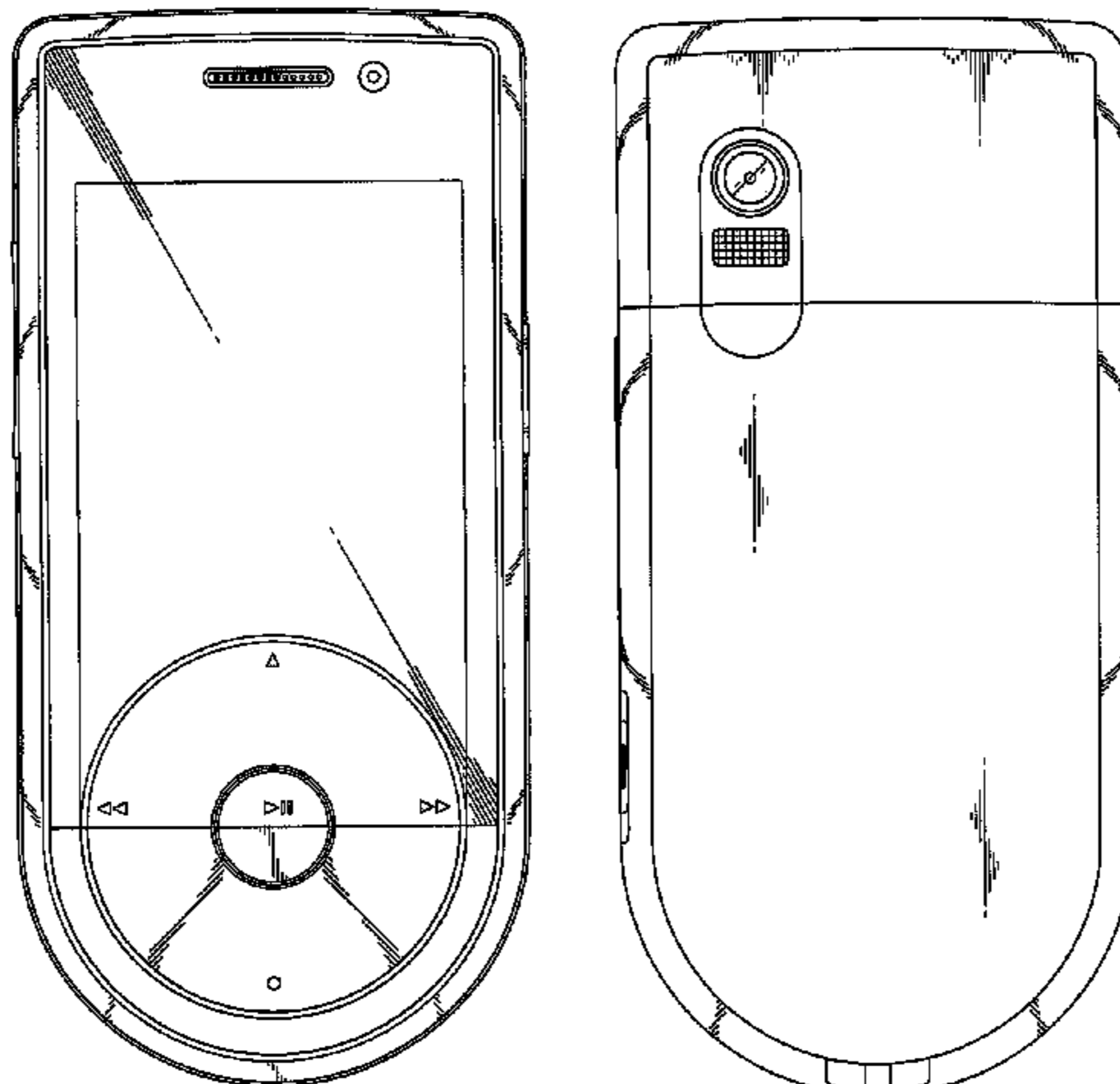

US D599,768 S

Page 2

U.S. PATENT DOCUMENTS

D555,136 S *	11/2007	Choi et al.	D14/138 AD	2004/0185921 A1*	9/2004	Tornaghi	455/575.1
D564,998 S *	3/2008	Tran et al.	D14/137	2006/0019726 A1*	1/2006	Park et al.	455/575.1
D586,677 S *	2/2009	Nothacker et al.	D10/78	2006/0264247 A1*	11/2006	Terzian et al.	455/572
2002/0094838 A1*	7/2002	Wang	455/550	2007/0270193 A1*	11/2007	Hsieh	455/575.1
2002/0102946 A1*	8/2002	SanGiovanni	455/90	2007/0287515 A1*	12/2007	Fagrenius et al.	455/575.4
				2008/0188273 A1*	8/2008	You	455/575.3

* cited by examiner

FIG. 1

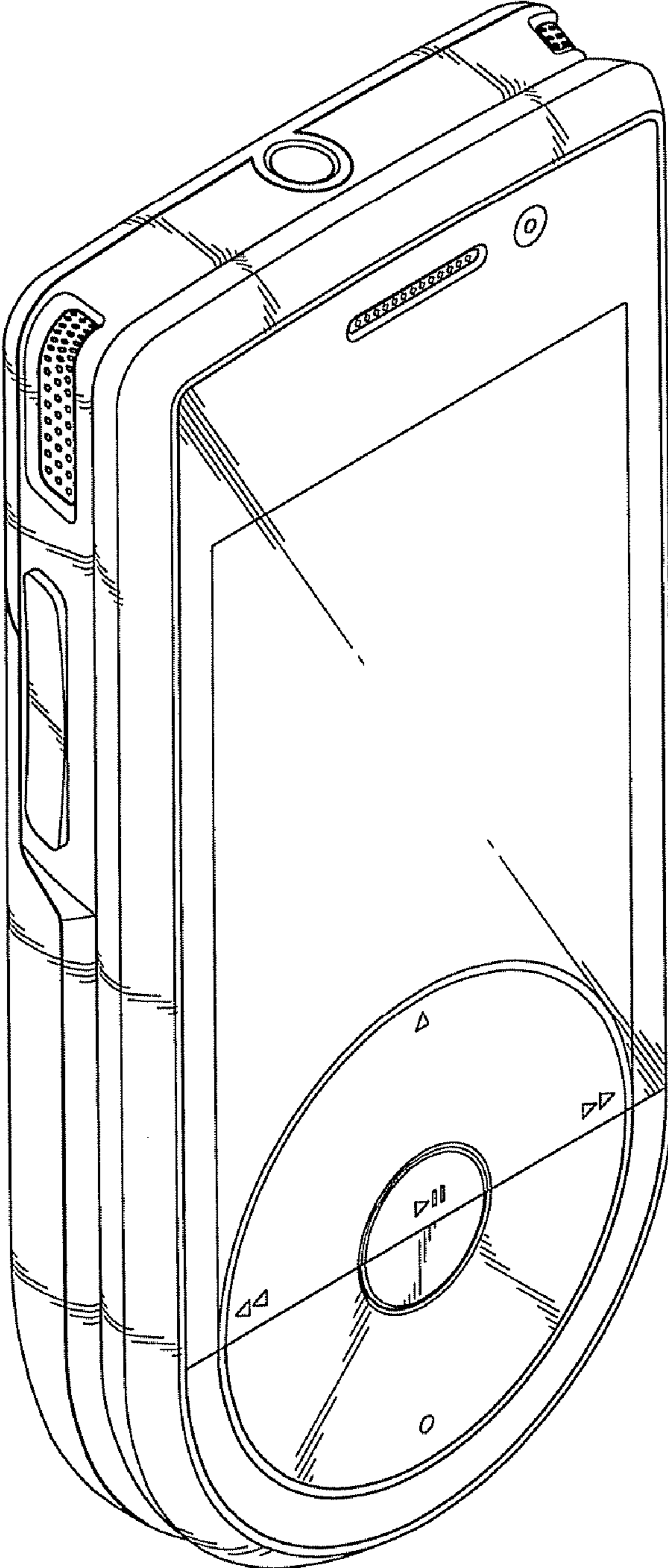

FIG. 2

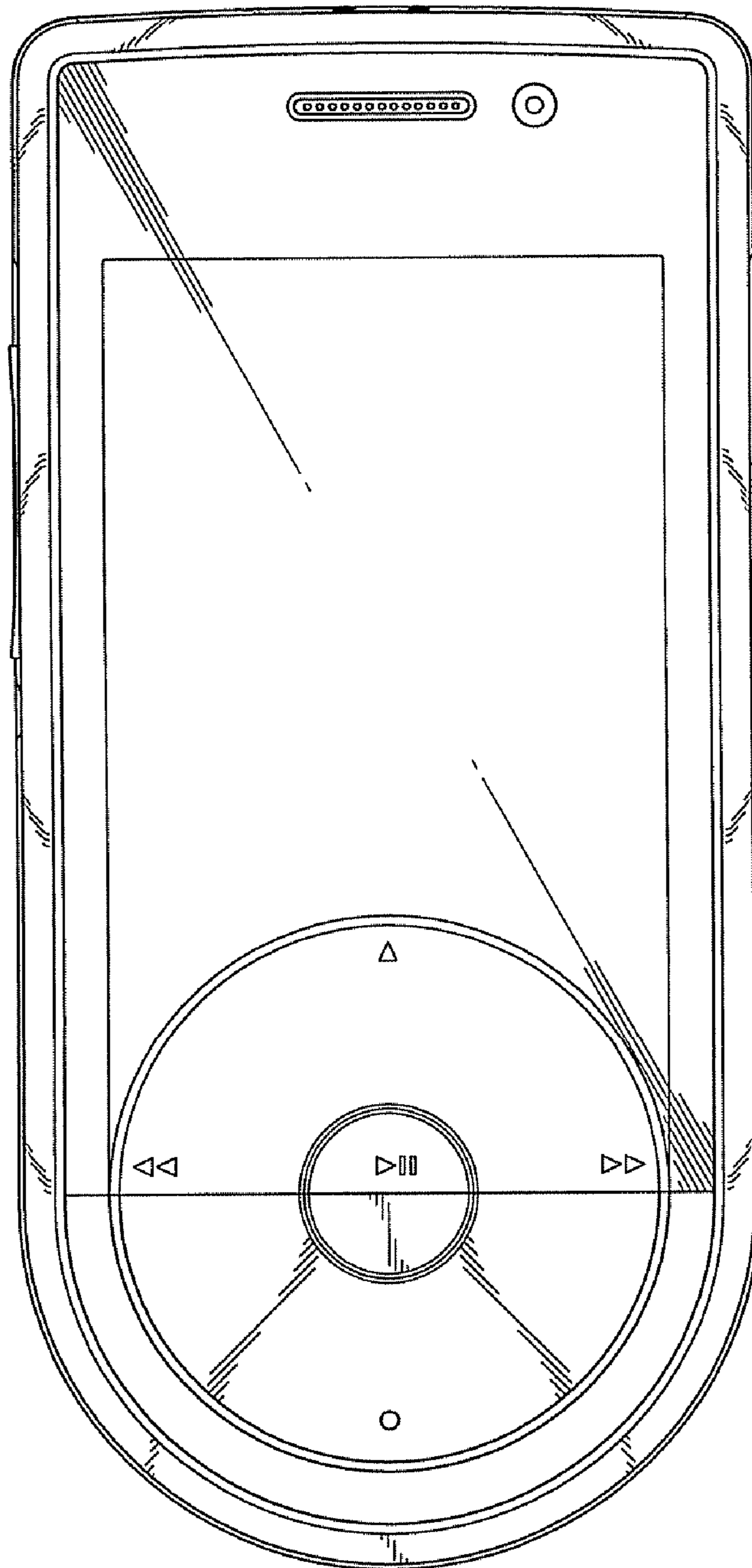

FIG. 3

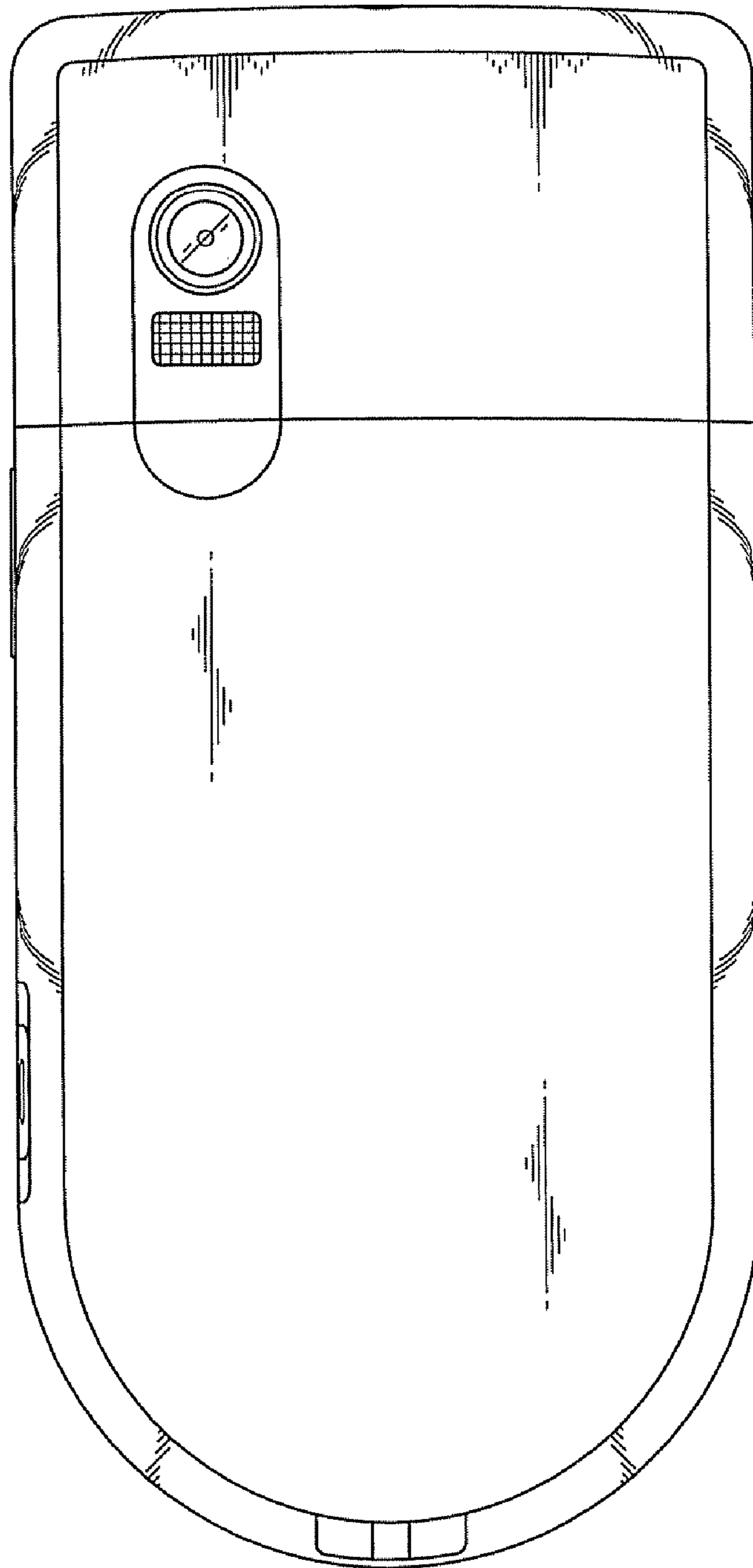

FIG. 4

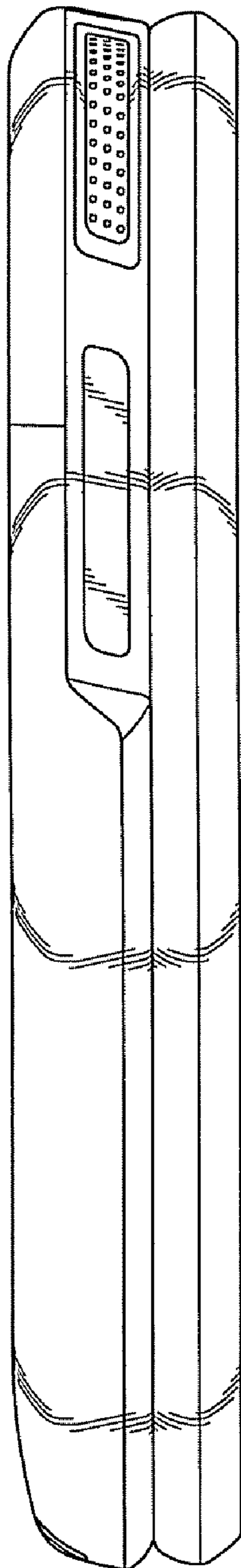

FIG. 5

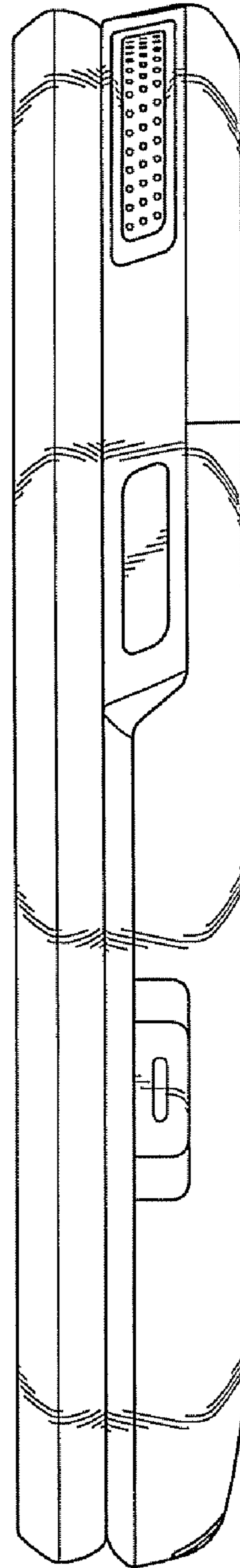

FIG. 6

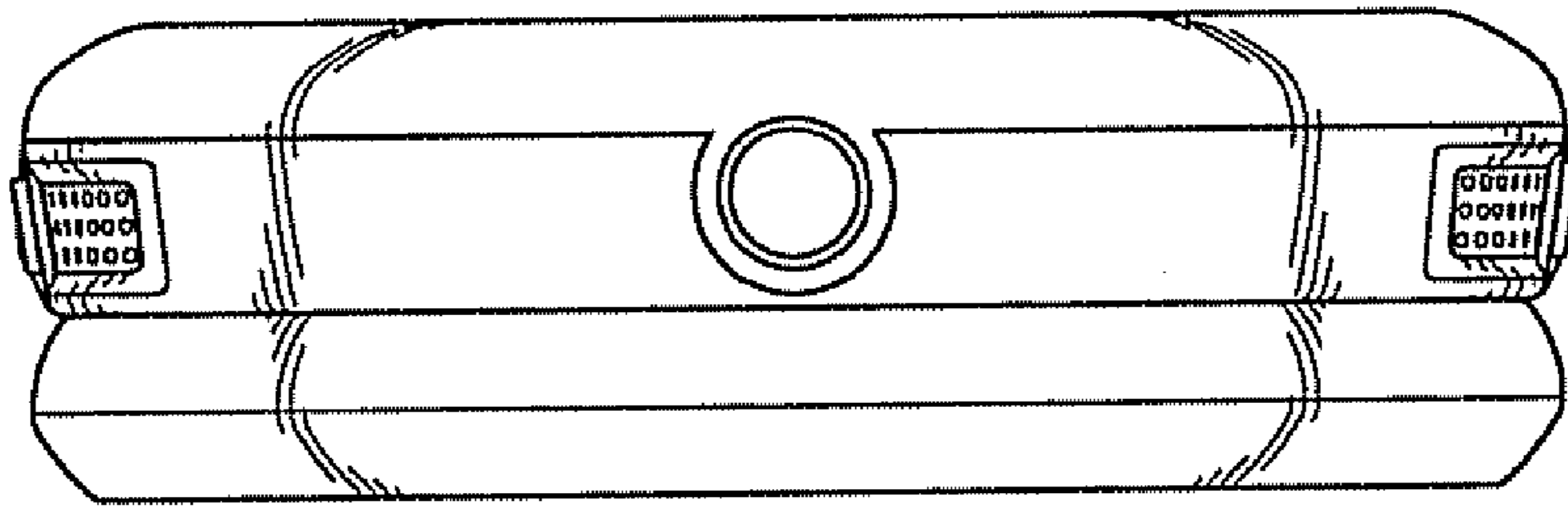

FIG. 7

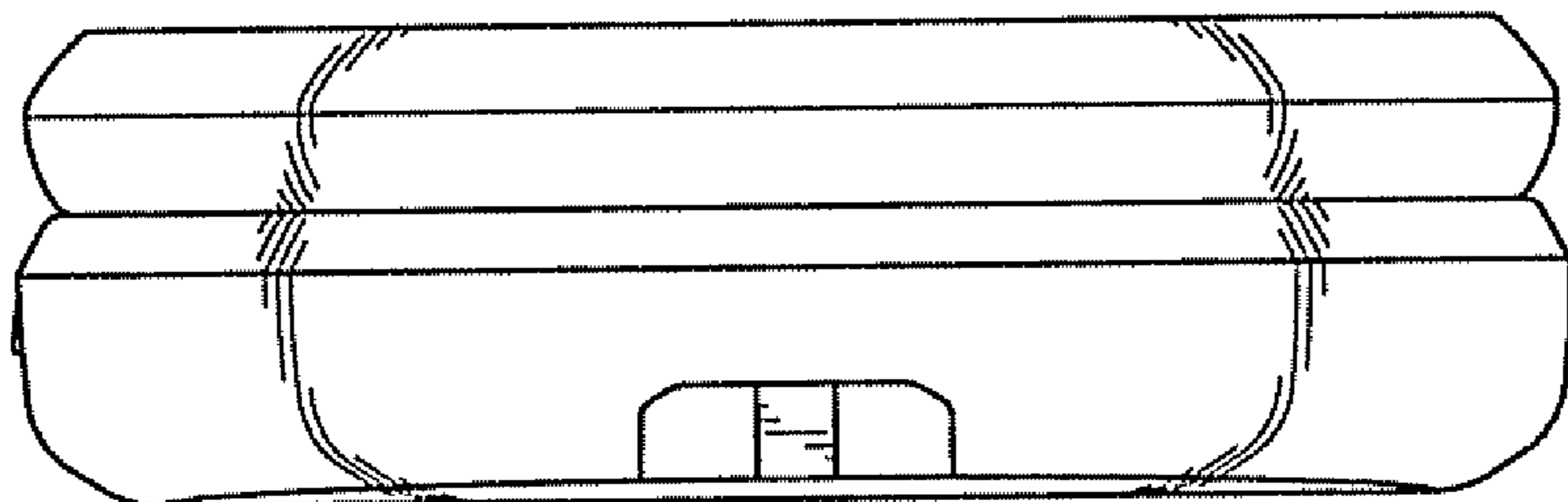

FIG. 8

