



US00D599758S

(12) **United States Design Patent**
Chiu

(10) **Patent No.:** **US D599,758 S**

(45) **Date of Patent:** **** Sep. 8, 2009**

(54) **DISPLAY**

(75) Inventor: **Yi-Chung Chiu**, Taipei County (TW)

(73) Assignee: **Hannspree, Inc.**, Taipei (TW)

(**) Term: **14 Years**

(21) Appl. No.: **29/330,477**

(22) Filed: **Jan. 8, 2009**

(51) **LOC (9) Cl.** **14-03**

(52) **U.S. Cl.** **D14/126**

(58) **Field of Classification Search** D14/125-134,
D14/239, 371, 136, 374-377, 440, 450, 448,
D14/336, 342; 312/7.2; 348/836, 838, 180,
348/184, 325, 739; 341/12; 248/917-924,
248/465; 345/104, 133, 156, 168, 87, 173;
720/605, 669, 600, 655; 369/99, 197; D21/329,
D21/515, 577, 622, 333, 433, 448, 452, 450,
D21/331, 604, 605; D6/477, 479, 332; 273/148 B;
446/484, 175, 356; D10/15, 26; D5/1, 2
See application file for complete search history.

(56) **References Cited**

U.S. PATENT DOCUMENTS

D486,131 S * 2/2004 Otsuka D14/126
D502,153 S * 2/2005 Peng D14/126

D521,468 S * 5/2006 Hoehn et al. D14/126
D522,980 S * 6/2006 Chu D14/126
D540,276 S * 4/2007 Naruo D14/126
D545,280 S * 6/2007 Imboden D14/126
D548,206 S * 8/2007 Han D14/126
D569,355 S * 5/2008 Hoehn et al. D14/126

* cited by examiner

Primary Examiner—Raphael Barkai

(74) *Attorney, Agent, or Firm*—Schmeiser, Olsen & Watts,
LLP

(57) **CLAIM**

The ornamental design for a display, as shown and described.

DESCRIPTION

FIG. 1 is a front perspective view of display showing my new design;

FIG. 2 is a front elevational view thereof;

FIG. 3 is a rear elevational view thereof;

FIG. 4 is a left side elevational view thereof;

FIG. 5 is a right side elevational view thereof;

FIG. 6 is a top plan view thereof; and,

FIG. 7 is a bottom plan view thereof.

1 Claim, 5 Drawing Sheets

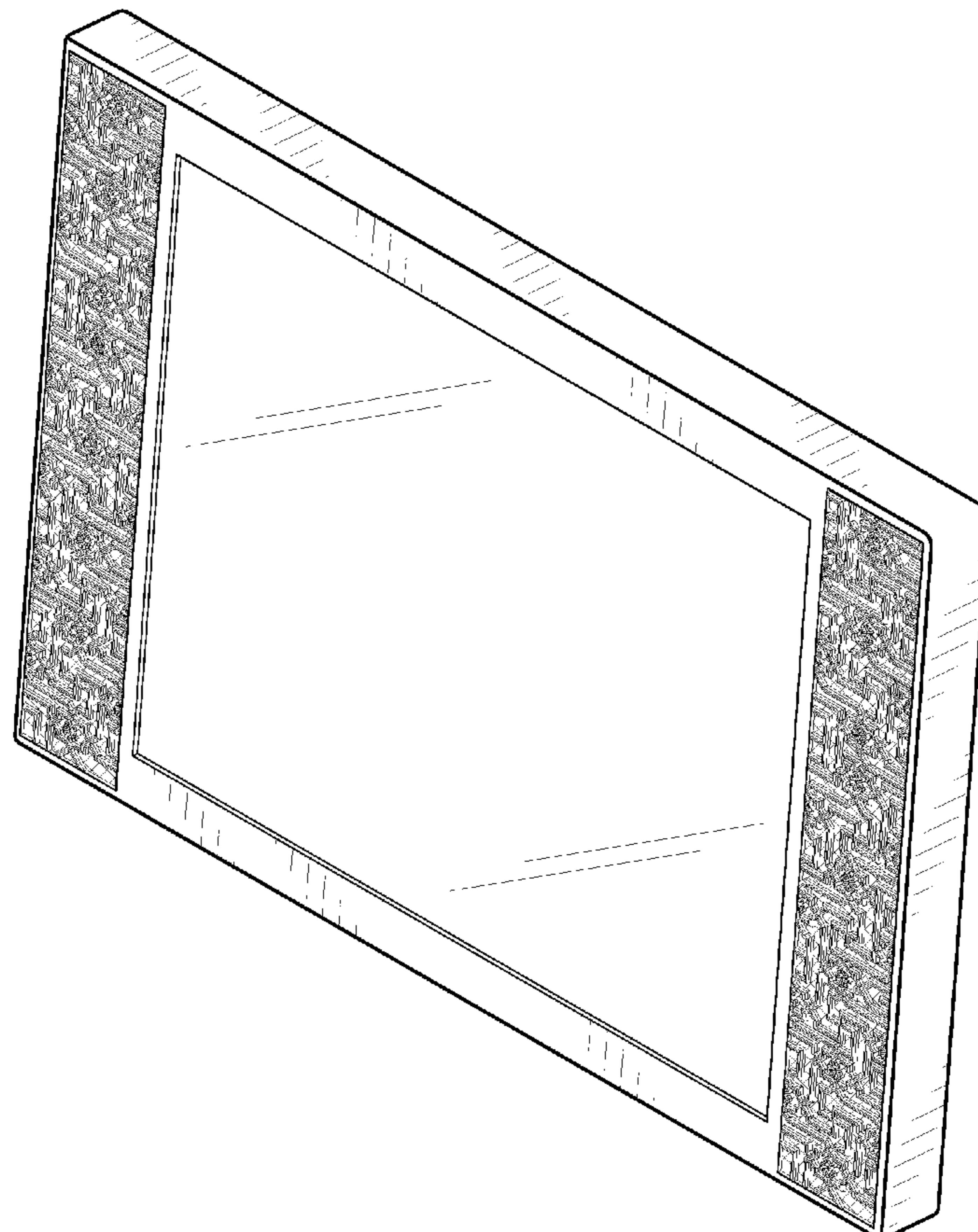

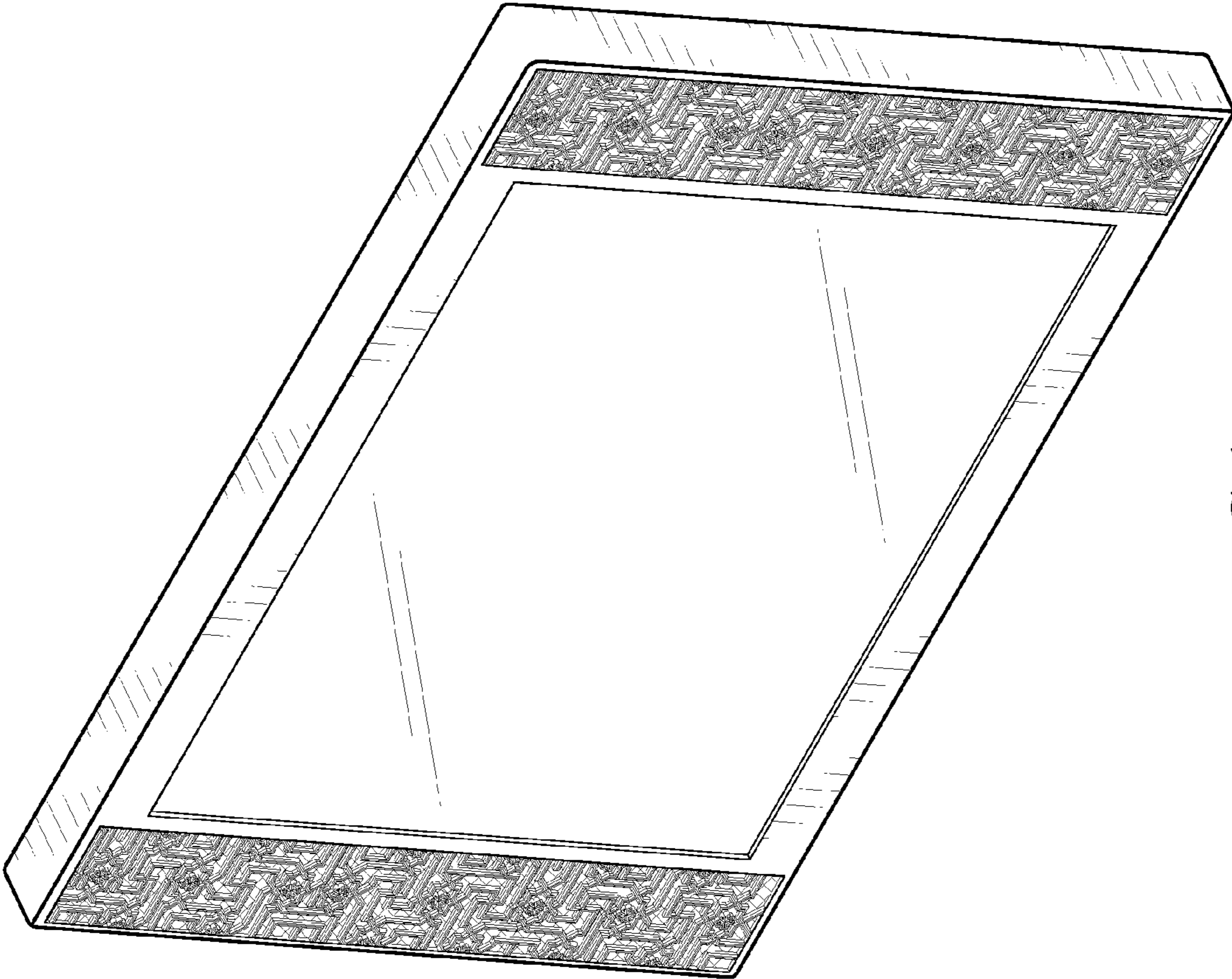

FIG.1

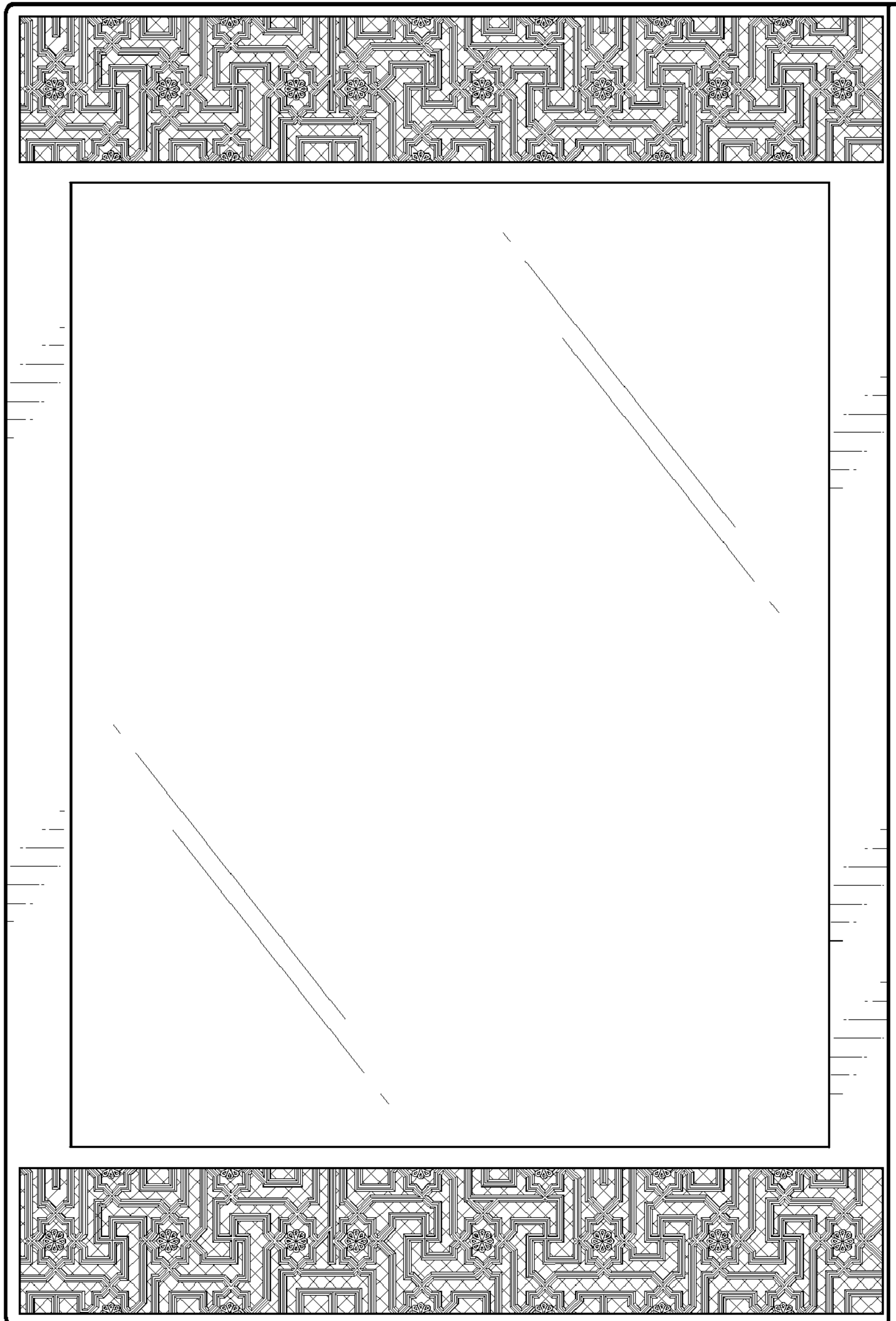

FIG.2

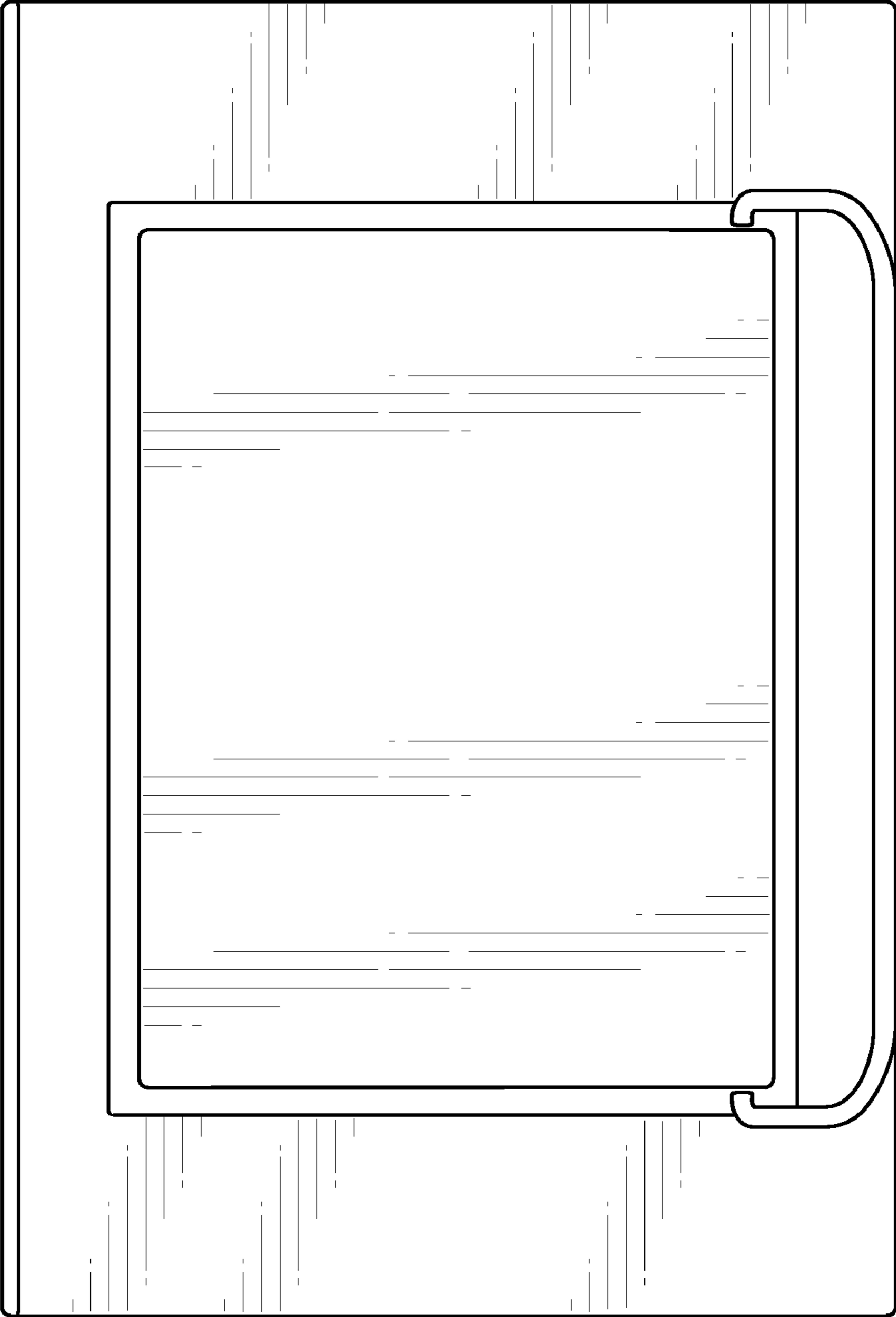

FIG.3

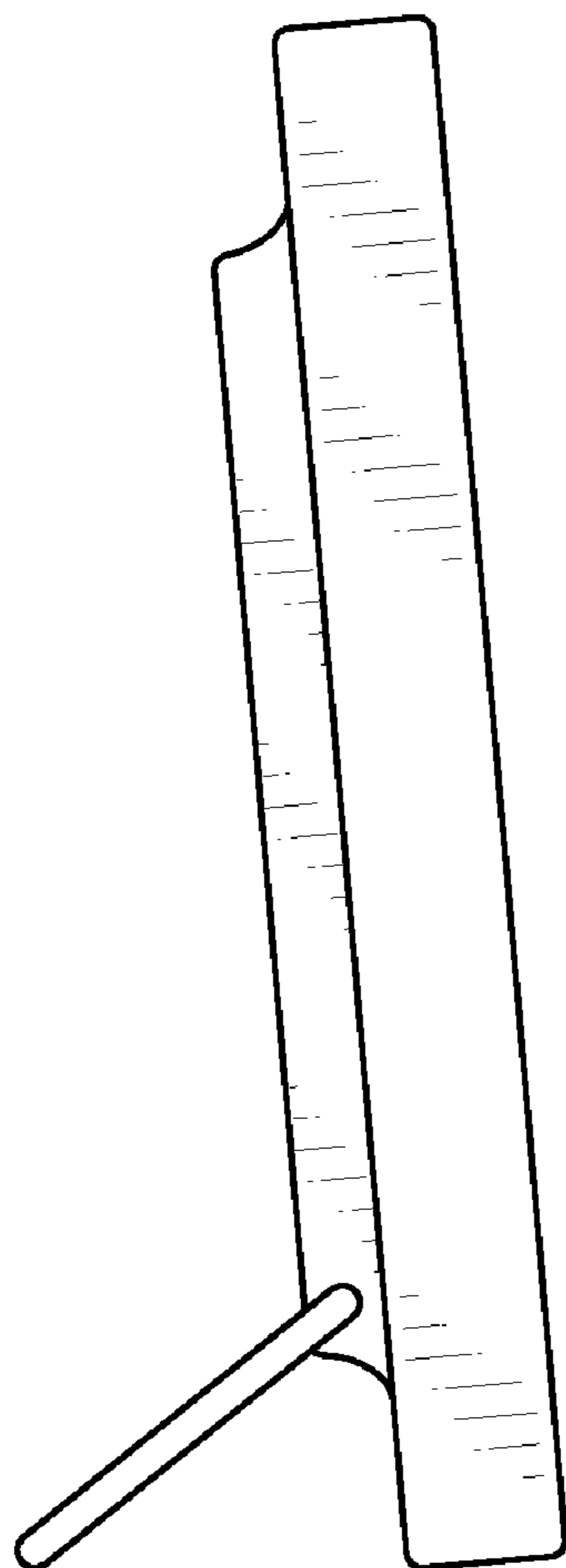

FIG. 4

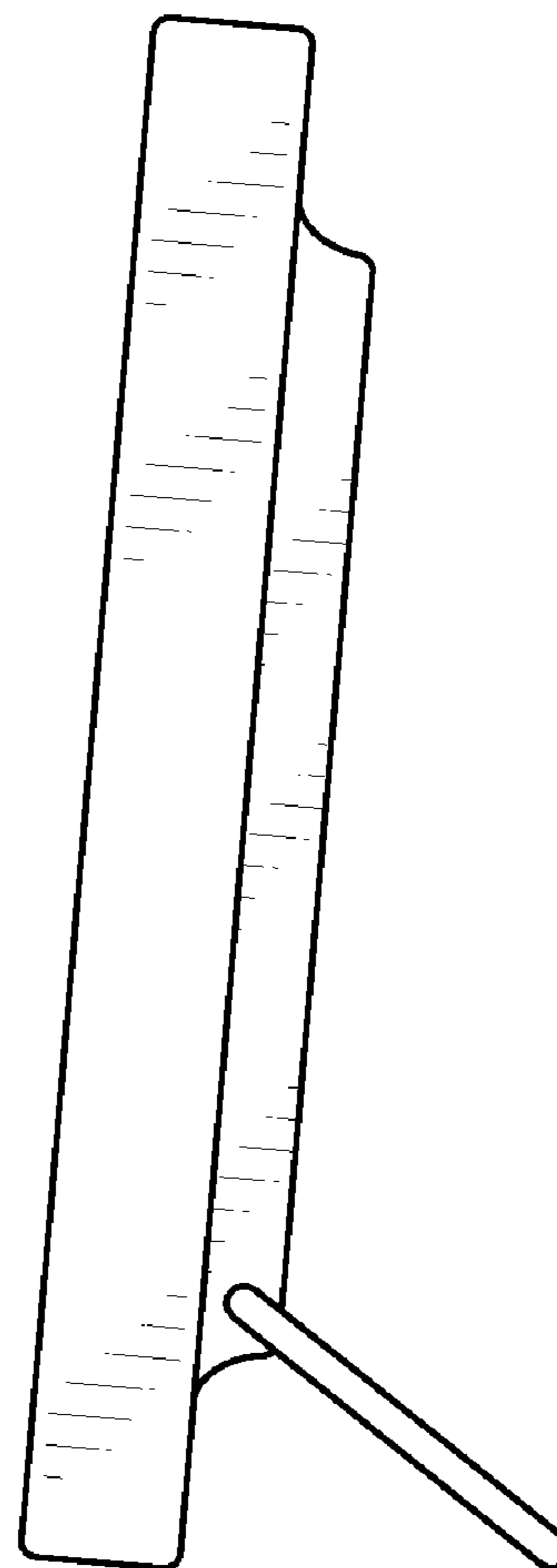

FIG. 5

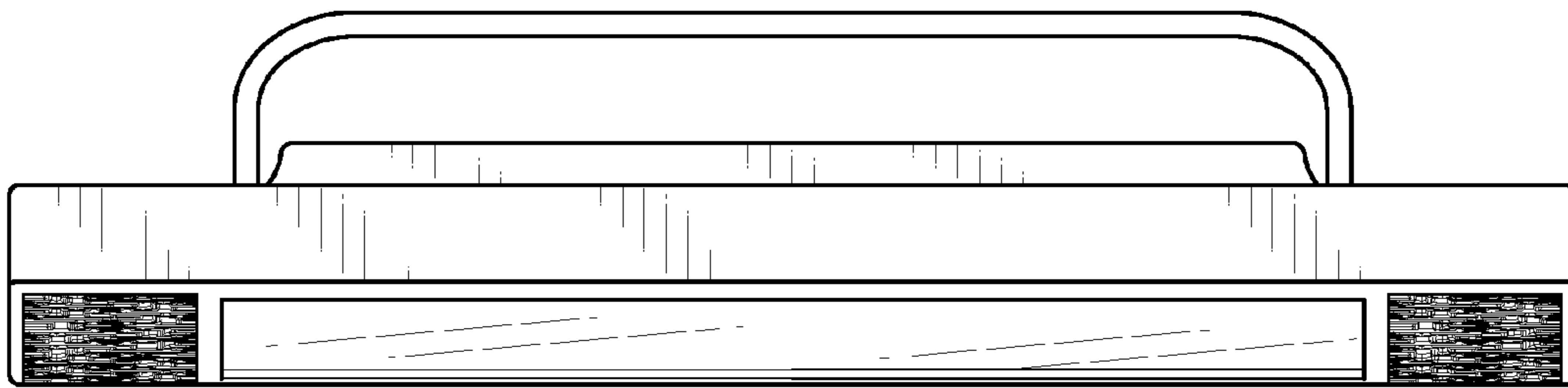

FIG.6

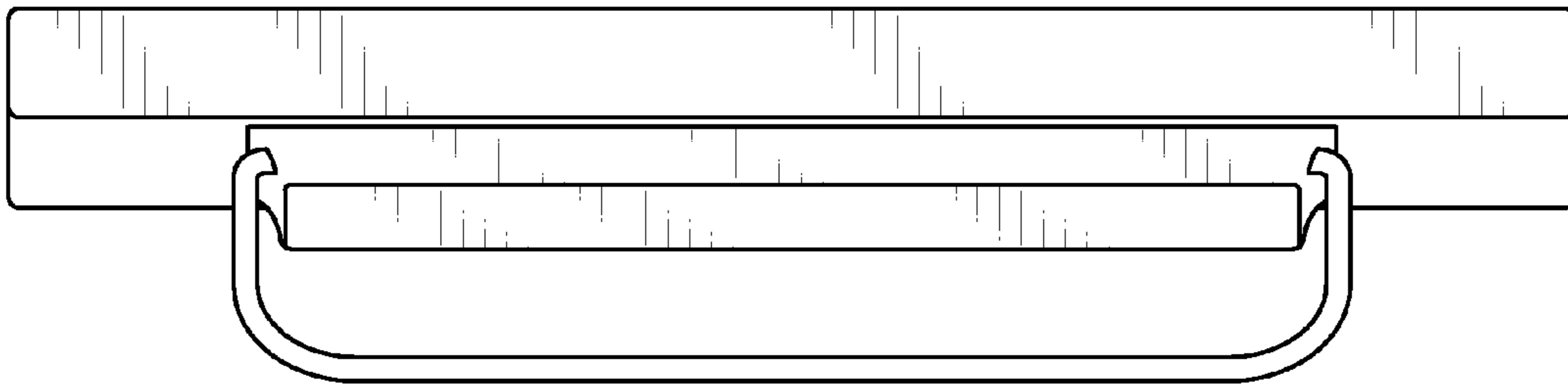

FIG.7