



US00D599691S

(12) **United States Design Patent**  
**Pohl et al.**

(10) **Patent No.:** **US D599,691 S**  
(45) **Date of Patent:** **\*\* Sep. 8, 2009**

(54) **SCALE**  
(75) Inventors: **Achim Pohl**, Seeheim-Jugenheim (DE);  
**Tomas Fiegl**, Darmstadt (DE)  
(73) Assignee: **Sartorius AG**, Goettingen (DE)  
(\*\*) Term: **14 Years**  
(21) Appl. No.: **29/313,876**  
(22) Filed: **Feb. 17, 2009**

6,844,507 B2 \* 1/2005 Leisinger et al. .... 177/180  
D514,966 S \* 2/2006 Leisinger et al. .... D10/91  
6,995,323 B2 \* 2/2006 Kunzi et al. .... 177/25.13  
7,423,226 B2 \* 9/2008 Rotach et al. .... 177/180  
D587,608 S \* 3/2009 Marmier ..... D10/91

\* cited by examiner

*Primary Examiner*—Antoine D Davis  
(74) *Attorney, Agent, or Firm*—Anthony J. Casella; Gerlad E. Hespos

(30) **Foreign Application Priority Data**  
Aug. 22, 2008 (EM) ..... 000990213  
(51) **LOC (9) Cl.** ..... **10-04**  
(52) **U.S. Cl.** ..... **D10/91**  
(58) **Field of Classification Search** ..... D10/91;  
177/4, 25.12–25.16, 177, 199, 210 R, 238–245,  
177/262, 210 C, 30, 126, 127, DIG. 3; 324/692,  
324/512, 515, 806; 606/506, 547  
See application file for complete search history.

(57) **CLAIM**

The ornamental design for a scale, as shown and described.

**DESCRIPTION**

FIG. 1 is a perspective view of a scale showing the new design;  
FIG. 2 is a front elevational view thereof;  
FIG. 3 is a right-side elevational view thereof, an elevational view of the left side being a mirror image;  
FIG. 4 is a rear view thereof;  
FIG. 5 is a top plan view thereof; and,  
FIG. 6 is a bottom plan view thereof.  
The portion shown in dashed lines forms no part of the claimed design.

(56) **References Cited**  
U.S. PATENT DOCUMENTS  
5,874,694 A \* 2/1999 Ruedisueli ..... 177/180  
6,246,018 B1 \* 6/2001 Schink ..... 177/180  
D458,859 S \* 6/2002 Dwertmann ..... D10/91  
6,633,007 B1 \* 10/2003 Luchinger et al. .... 177/126

**1 Claim, 6 Drawing Sheets**

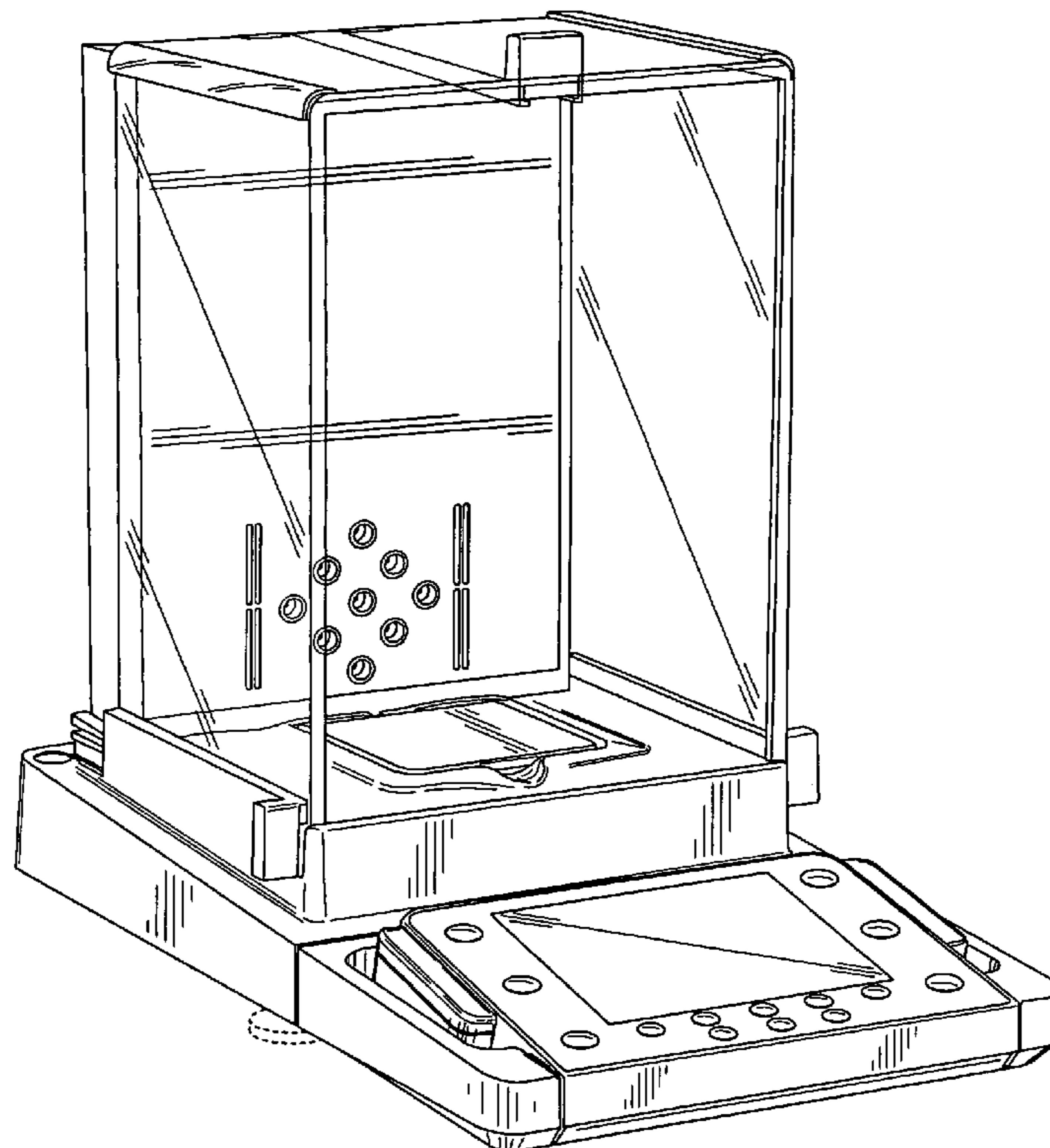

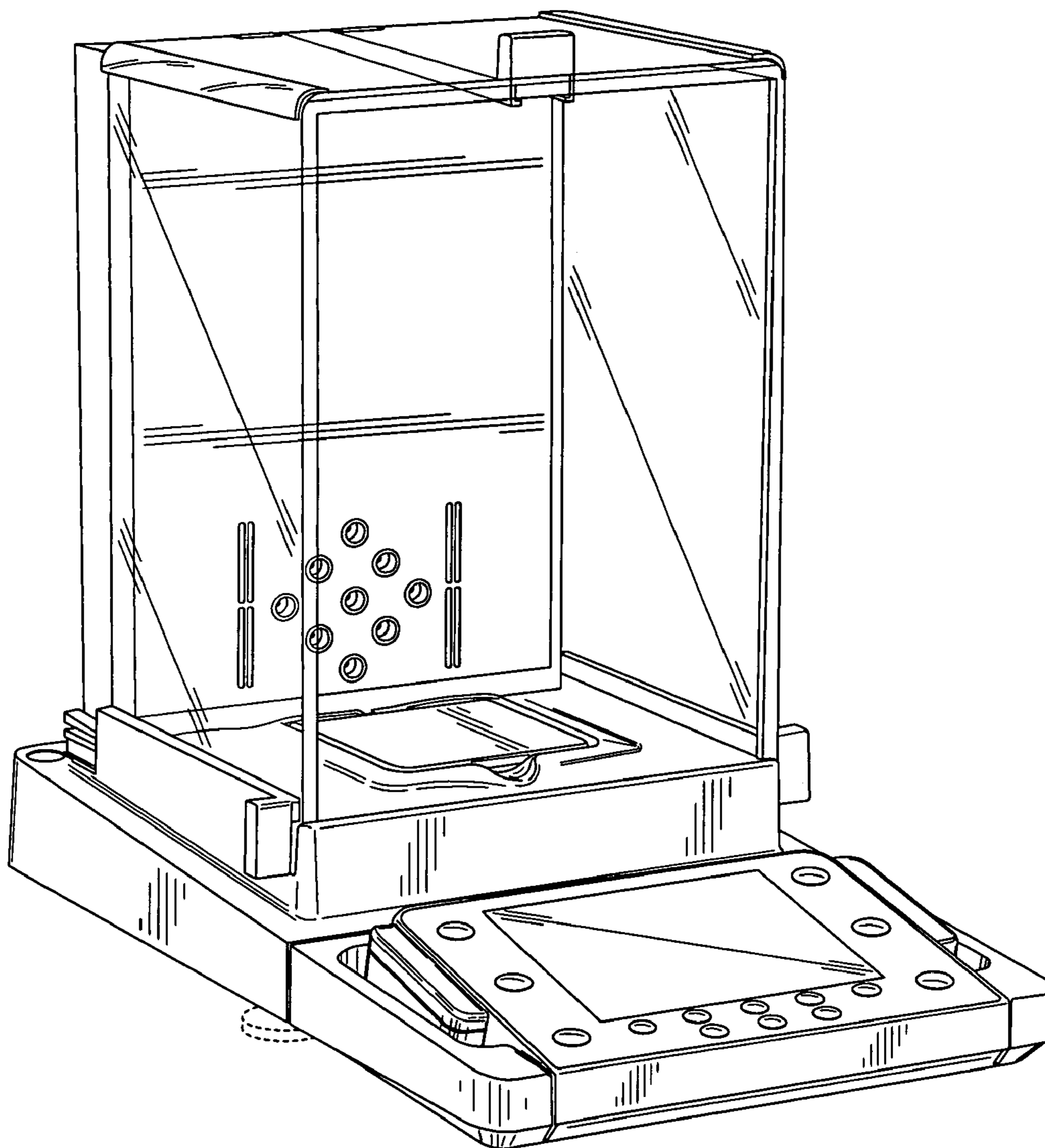
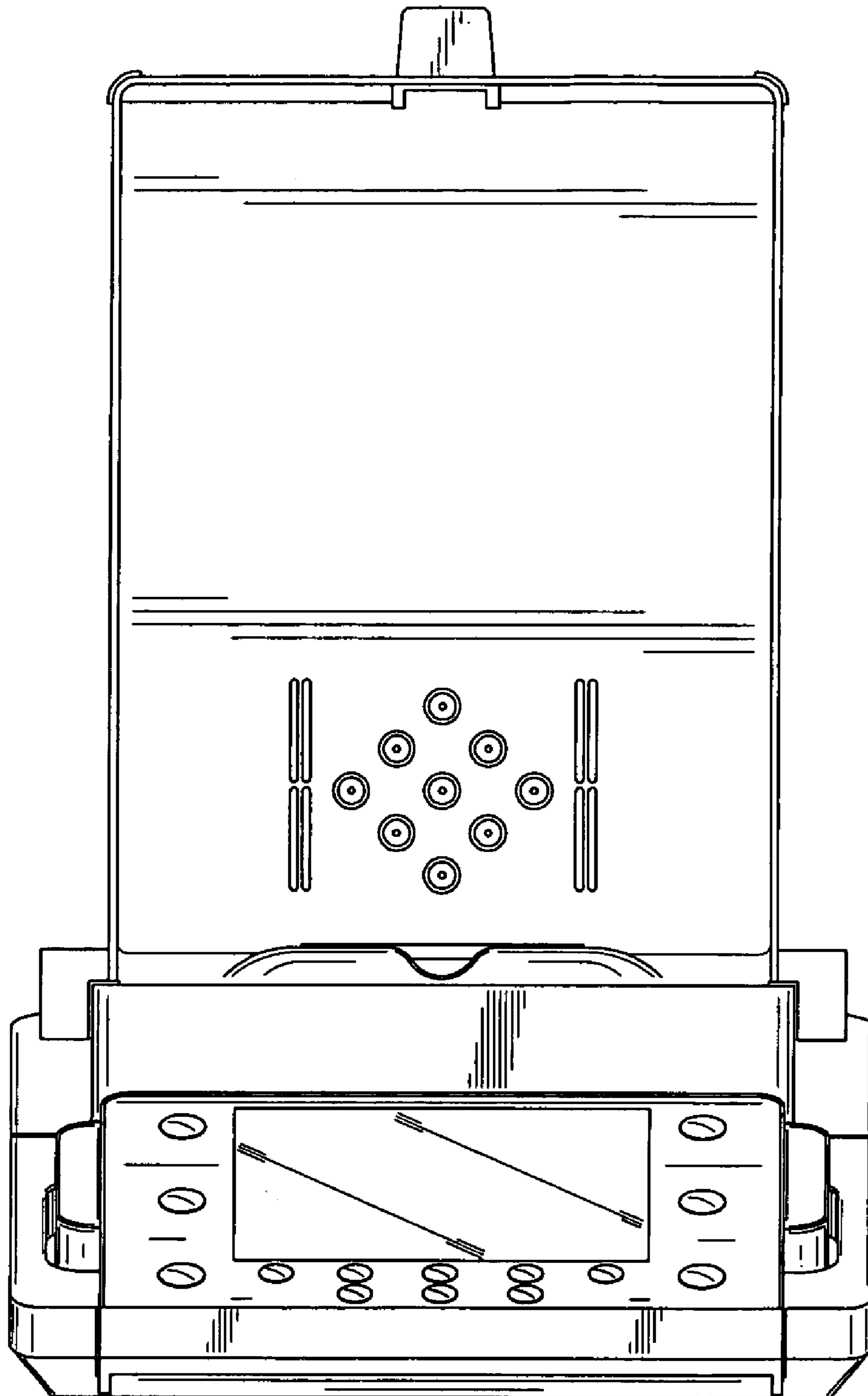

FIG. 1



**FIG. 2**

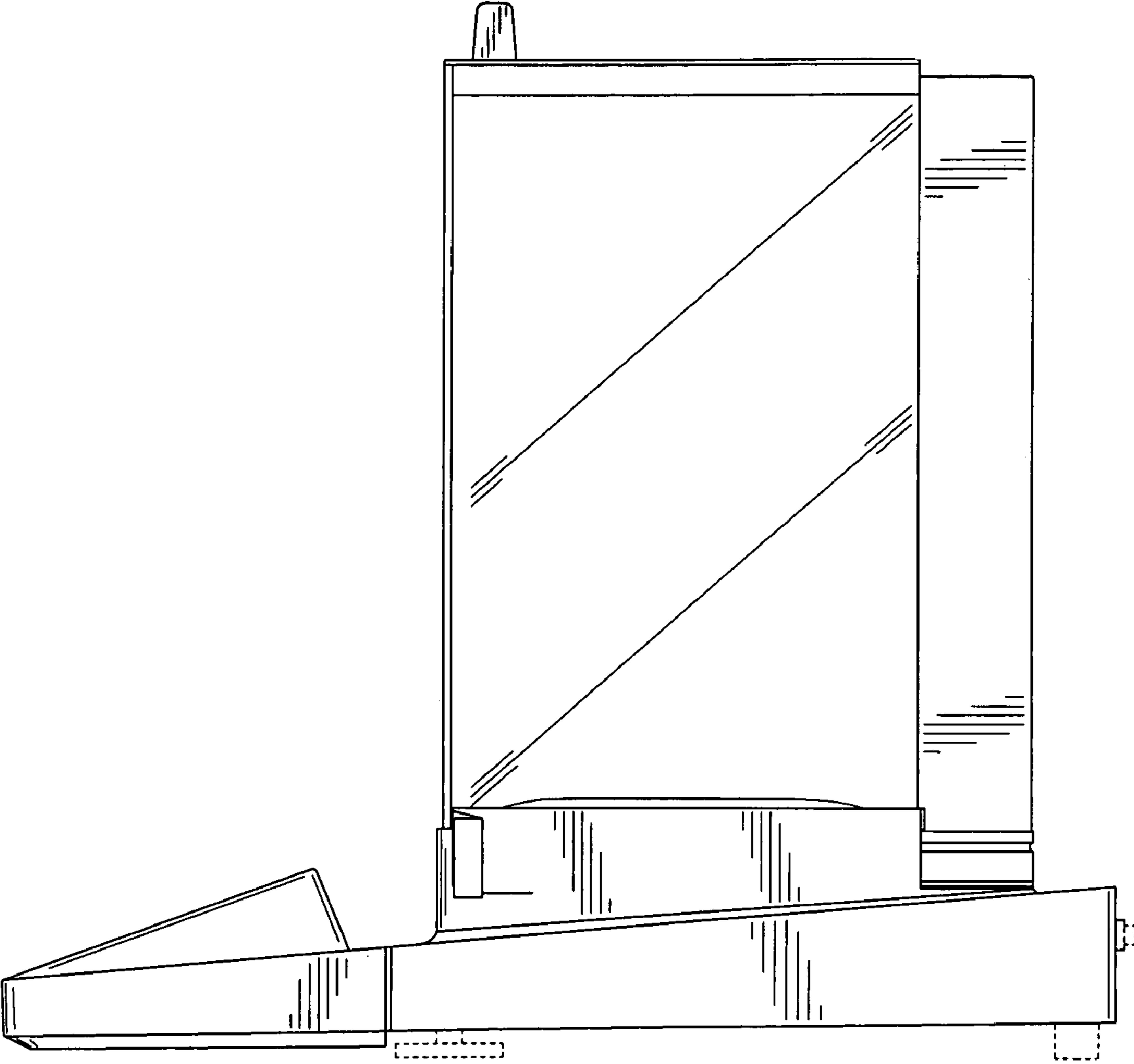
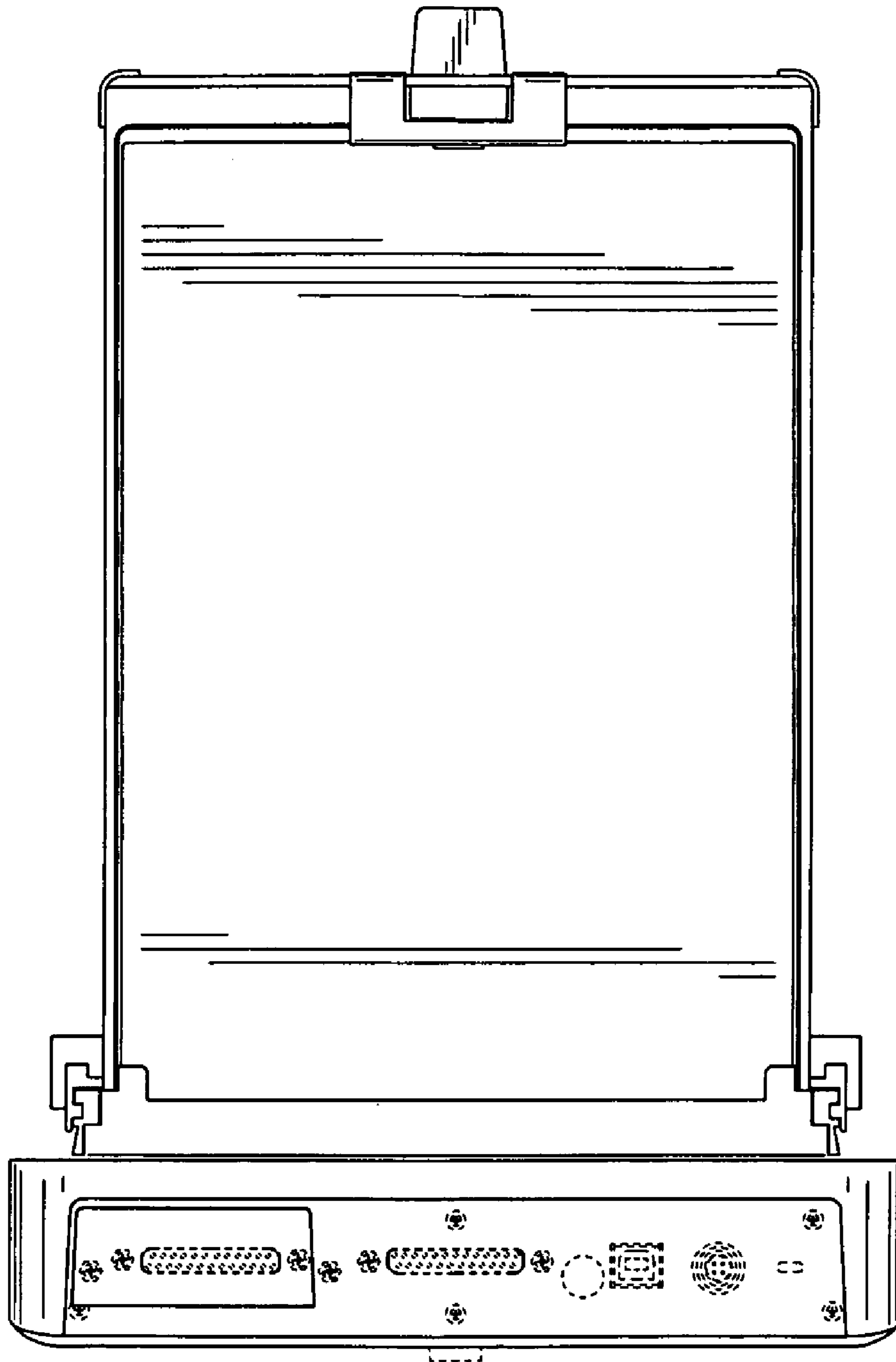
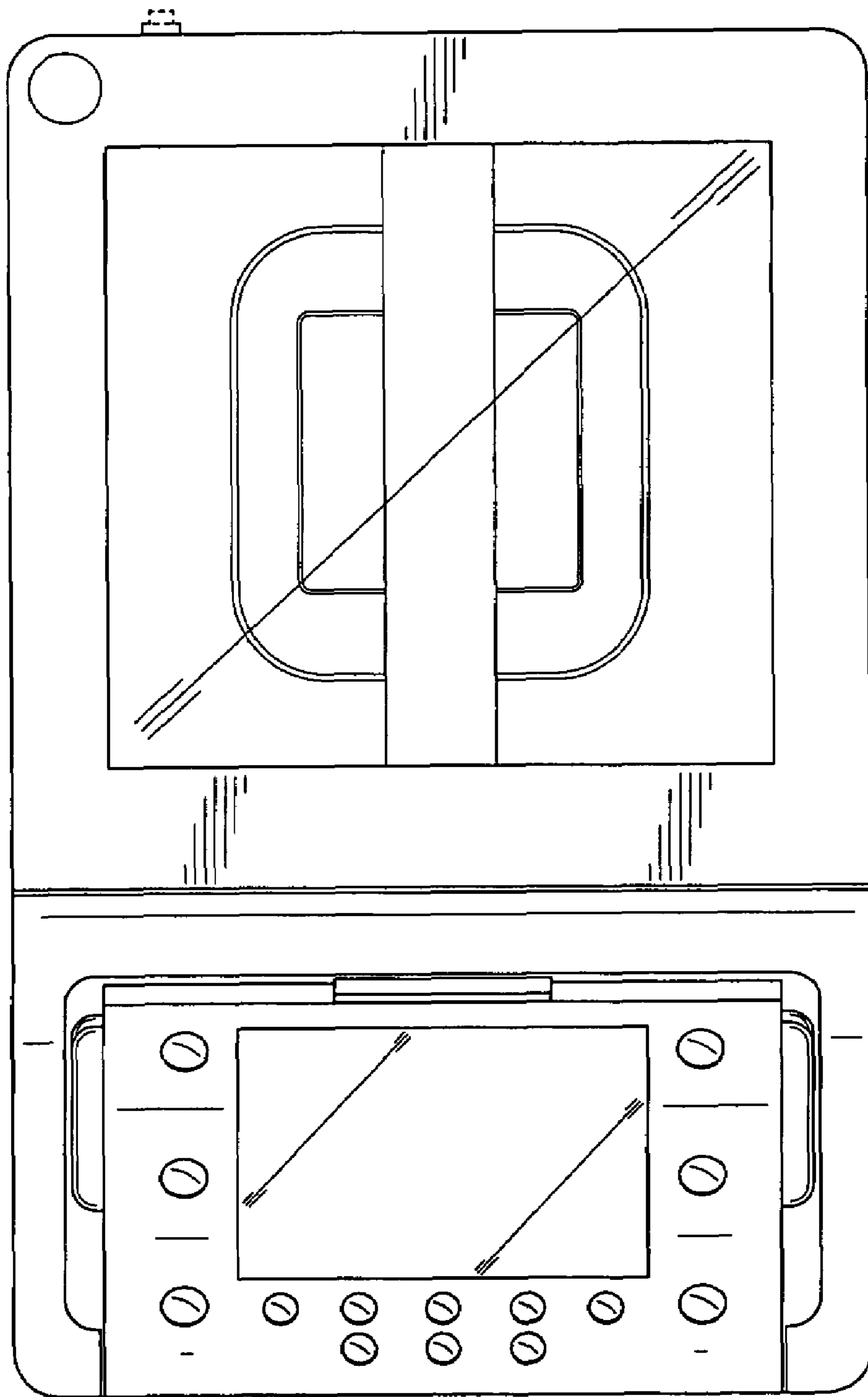

FIG. 3



**FIG. 4**



**FIG. 5**

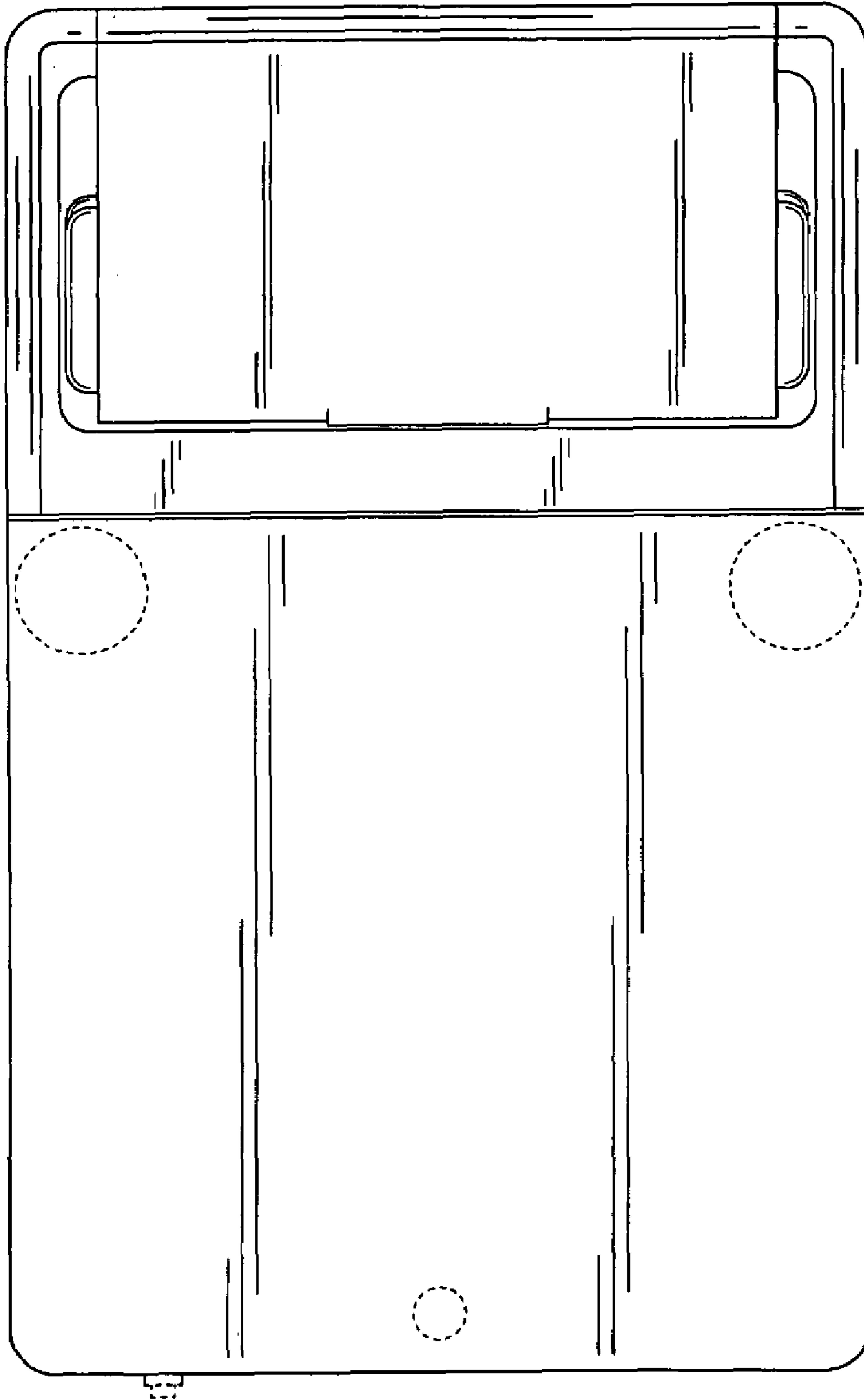

**FIG. 6**