



US00D599654S

(12) **United States Design Patent**
Kosaka et al.

(10) **Patent No.:** **US D599,654 S**

(45) **Date of Patent:** **** Sep. 8, 2009**

(54) **CIGARETTE PACKET**

(75) Inventors: **Yuichi Kosaka**, Tokyo (JP); **Daniel Tabrah**, Millbrook (GB)

(73) Assignee: **British American Tobacco (Investments) Limited**, London (GB)

(**) Term: **14 Years**

(21) Appl. No.: **29/299,030**

(22) Filed: **Dec. 18, 2007**

(30) **Foreign Application Priority Data**

Jun. 19, 2007 (EM) 000745278

(51) **LOC (9) Cl.** **09-03**

(52) **U.S. Cl.** **D9/415; D9/420; D9/424; D9/425; D9/756; D9/418**

(58) **Field of Classification Search** D9/414, D9/415, 418, 420, 422, 423, 424, 425, 426, D9/432, 756, 737; D27/186-191; 206/769, 206/770, 733, 734, 223, 242, 251, 261, 467, 206/470, 464, 462, 256, 263

See application file for complete search history.

(56) **References Cited**

U.S. PATENT DOCUMENTS

1,512,098	A *	10/1924	Hough	206/251
3,062,365	A *	11/1962	Fletcher	206/256
D283,488	S *	4/1986	Stevens	D9/415
D365,984	S *	1/1996	Hofmann	D9/415
5,593,036	A *	1/1997	Dyble et al.	206/464
5,749,461	A *	5/1998	Guzman	206/245
D408,151	S *	4/1999	Drees et al.	D4/199
D427,900	S *	7/2000	O'Malley et al.	D9/415
D429,638	S *	8/2000	Li et al.	D9/415
D483,260	S *	12/2003	Calzavara	D9/415
D494,464	S *	8/2004	Kumakura et al.	D9/415
D578,873	S *	10/2008	Plumer	D9/415
2006/0000738	A1 *	1/2006	Kumakura et al.	206/470
2007/0125666	A1 *	6/2007	Nazari	206/45.24

* cited by examiner

Primary Examiner—Stella M Reid

Assistant Examiner—Mark A Goodwin

(74) *Attorney, Agent, or Firm*—Charles I Sherman; Middleton Reutlinger

(57) **CLAIM**

The ornamental design for a cigarette packet, as shown and described.

DESCRIPTION

FIG. 1 is a front view of a first embodiment of a cigarette packet showing our new design in an open position;

FIG. 2 is a side view of the embodiment of FIG. 1 in an open position; the other side view being a mirror image;

FIG. 3 is a front view of the embodiment of FIG. 1 in a closed position;

FIG. 4 is a rear view of the embodiment of FIG. 1 in a closed position;

FIG. 5 is a side view of the embodiment of FIG. 1 in a closed position; the other side view being a mirror image;

FIG. 6 is a top view of the embodiment of FIG. 1 in an open position;

FIG. 7 is a bottom view of the embodiment of FIG. 1 in an open position;

FIG. 8 is a front view of a second embodiment of a cigarette packet showing our new design in an open position;

FIG. 9 is a side view of the embodiment of FIG. 8 in an open position; the other side being a mirror image;

FIG. 10 is a front view of the embodiment of FIG. 8 in a closed position;

FIG. 11 is a rear view of the embodiment of FIG. 8 in a closed position;

FIG. 12 is a side view of the embodiment of FIG. 8 in a closed position; the other side being a mirror image.

FIG. 13 is a top view of the embodiment of FIG. 8 in an open position; and,

FIG. 14 is a bottom view of the embodiment of FIG. 8 in an open position.

The broken lines are for illustrative purposes only and form no part of the claimed design.

1 Claim, 14 Drawing Sheets

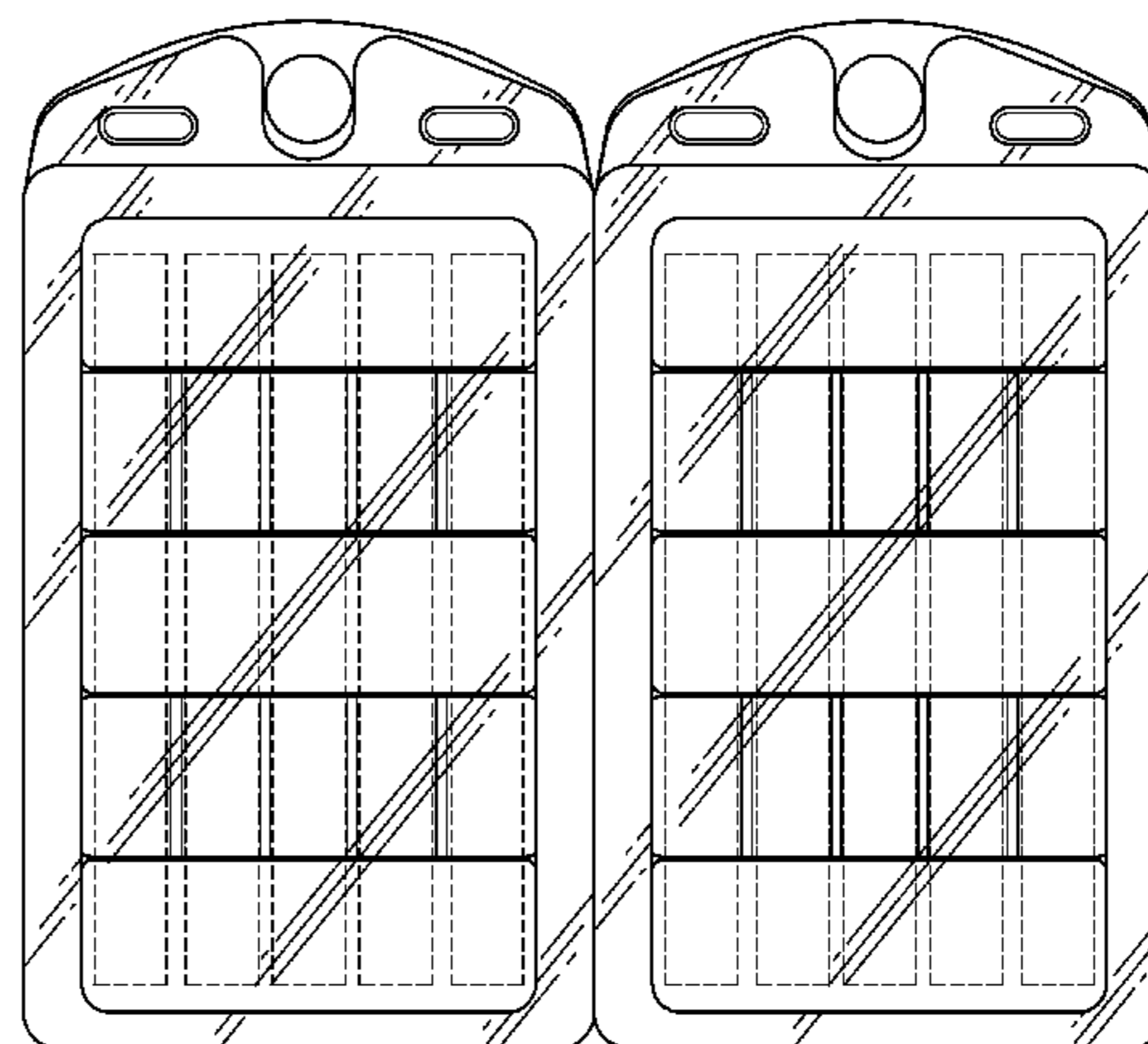
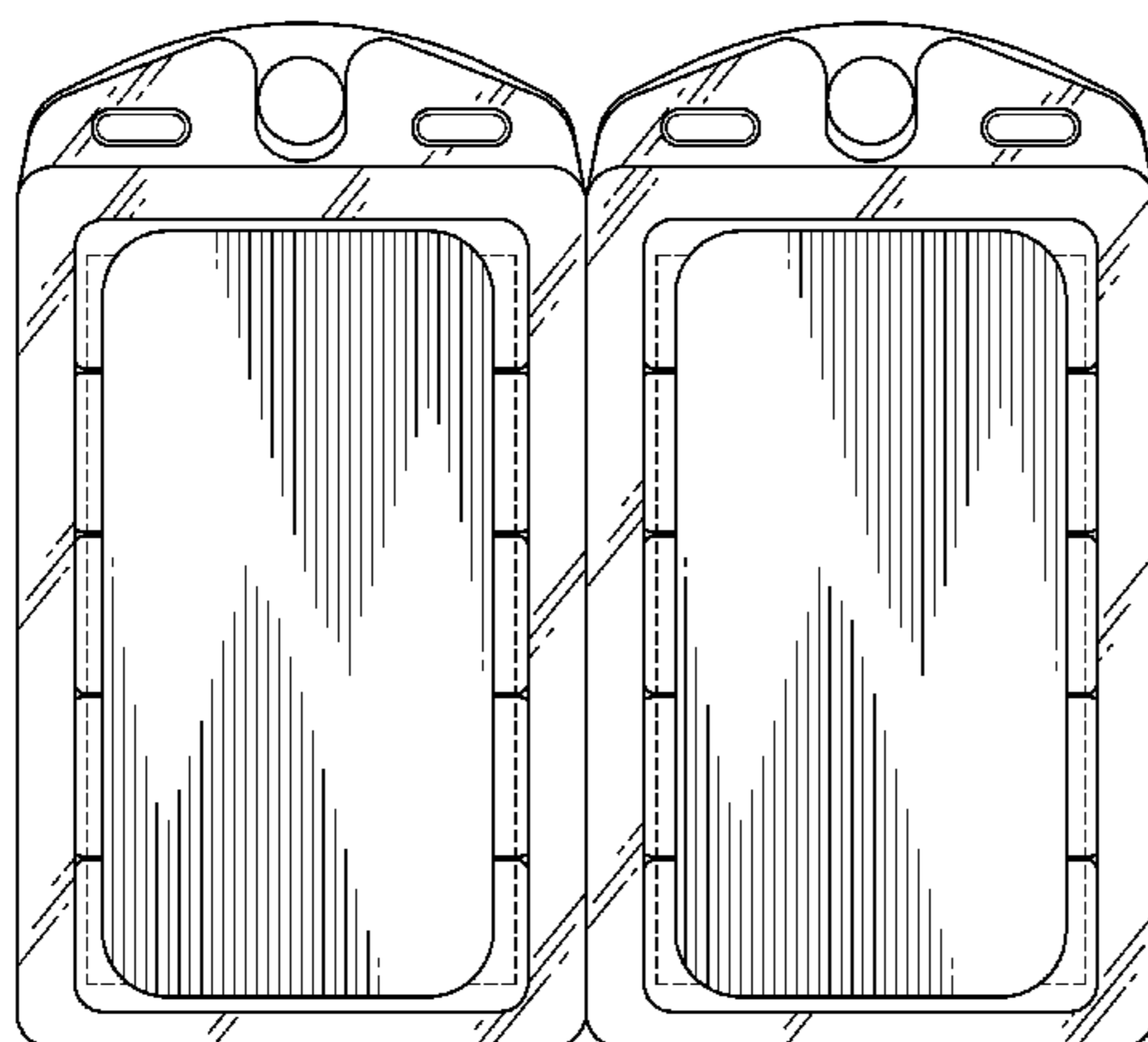

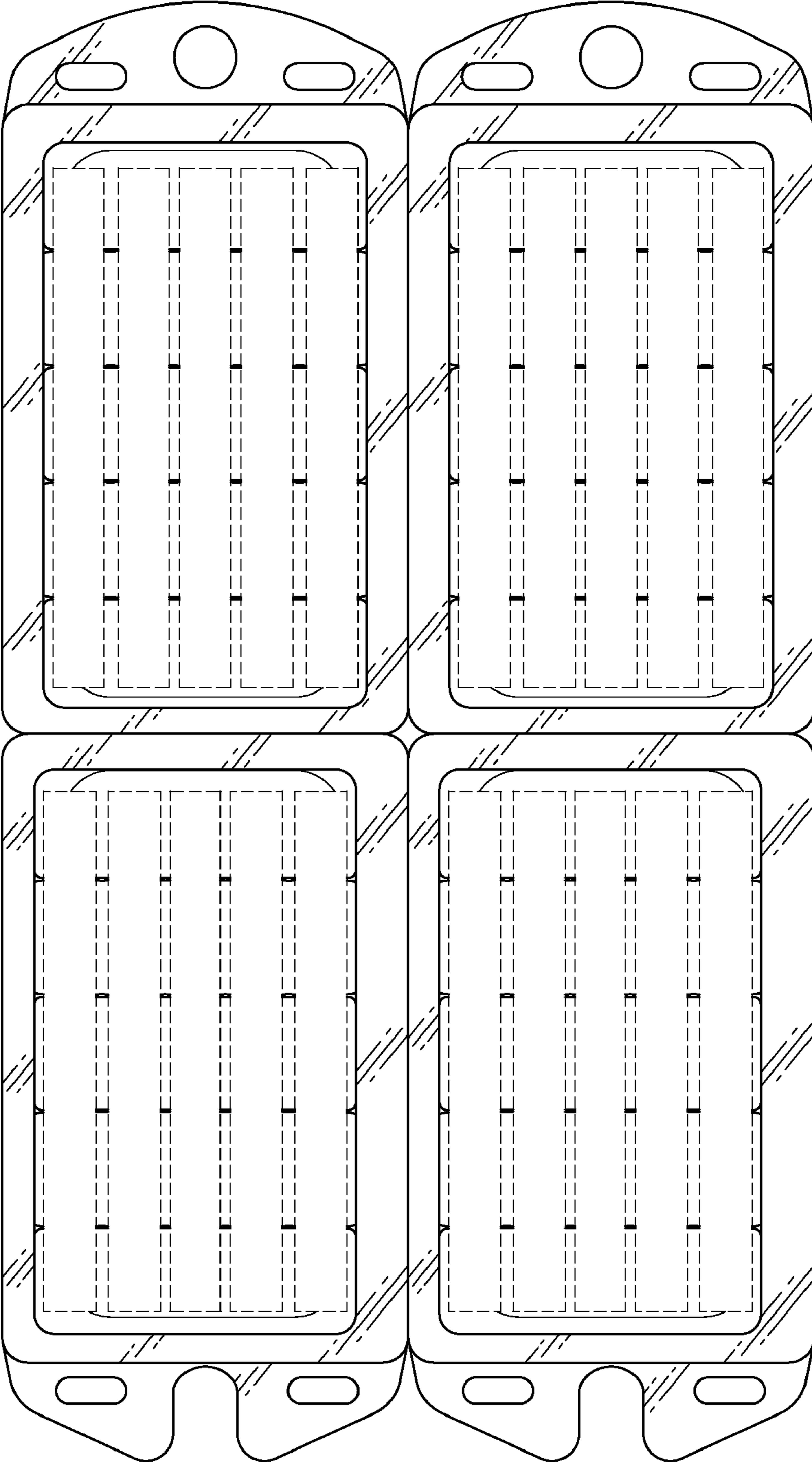

FIG. 1

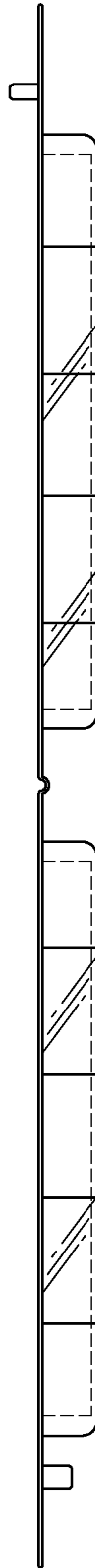

FIG. 2

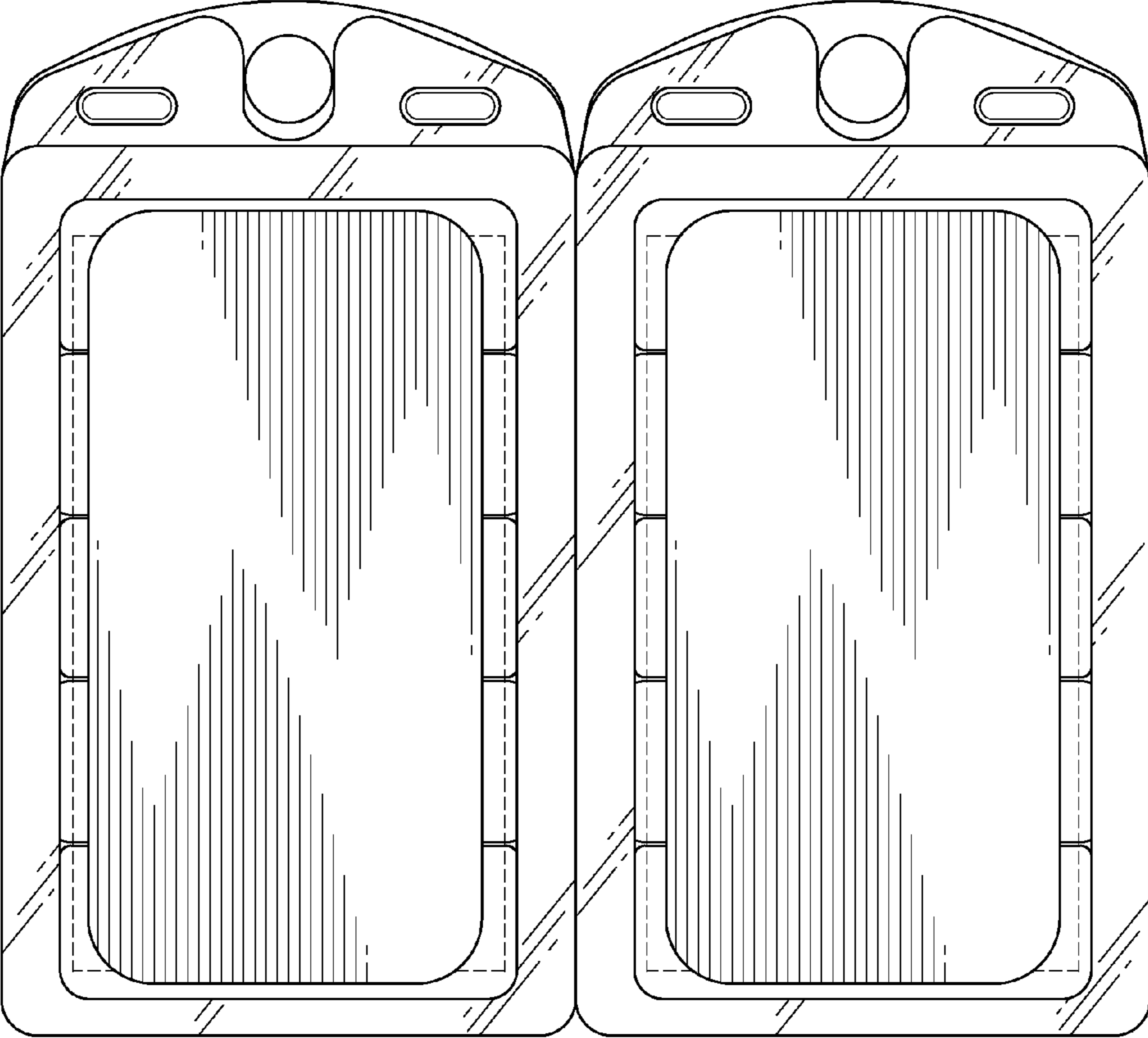

FIG. 3

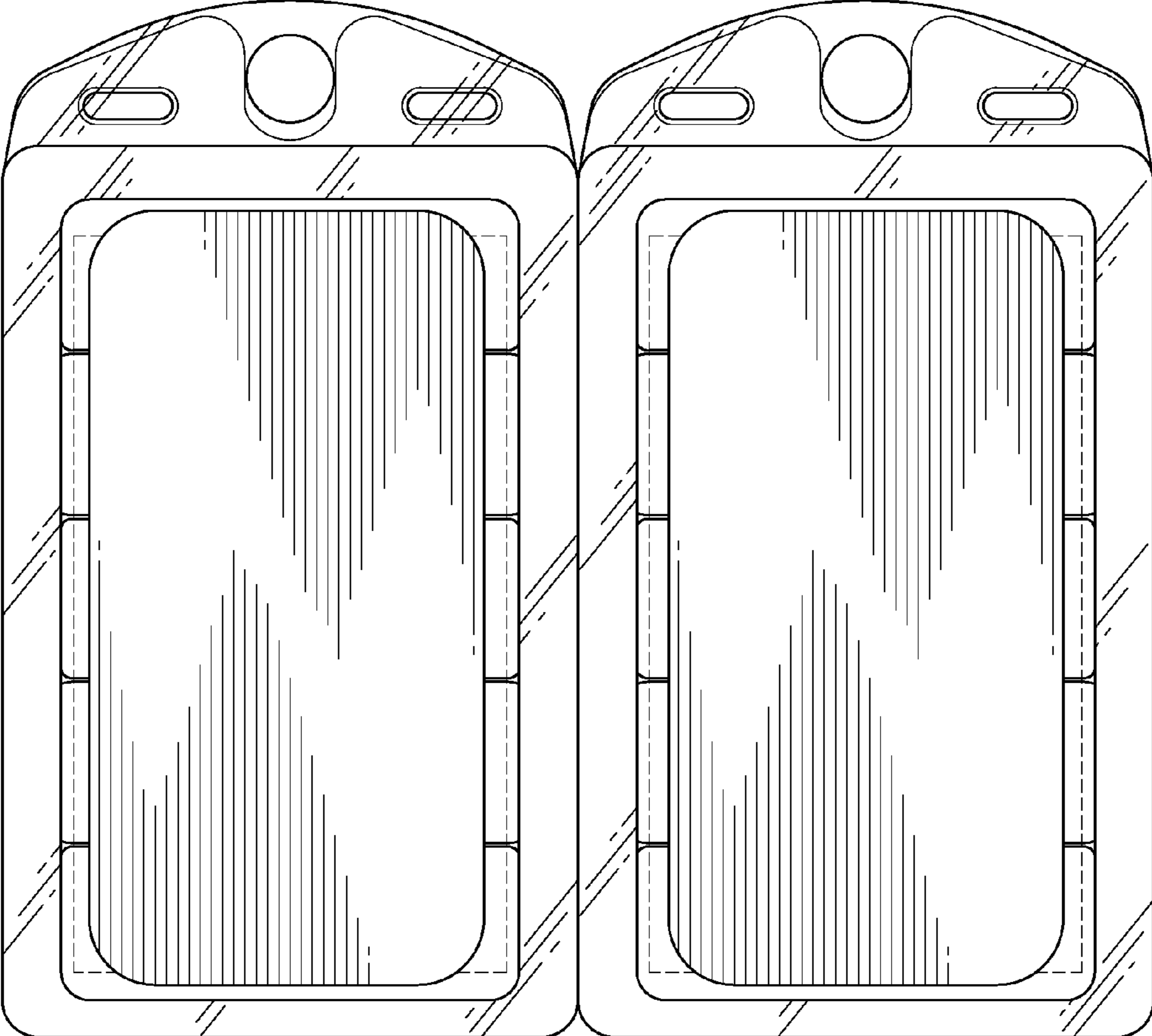

FIG. 4

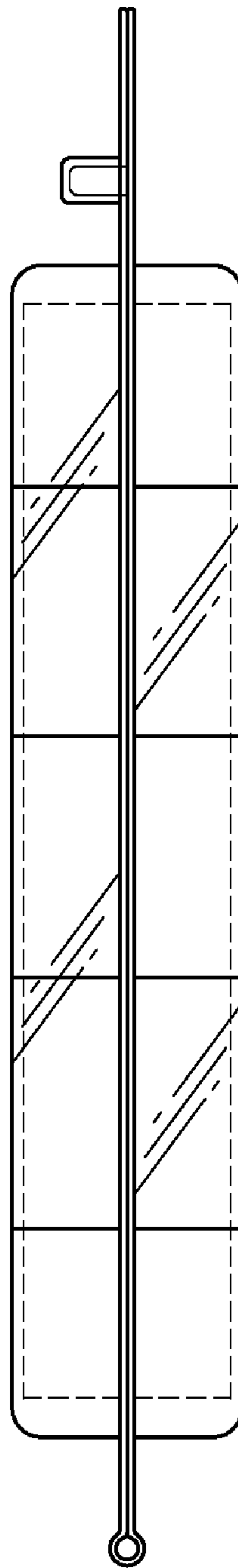

FIG. 5

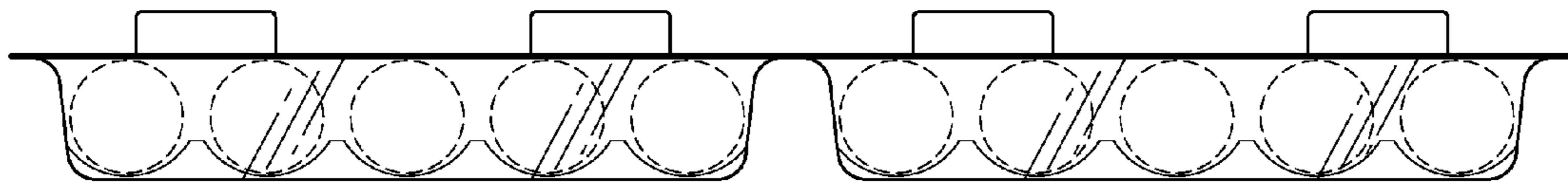

FIG. 6

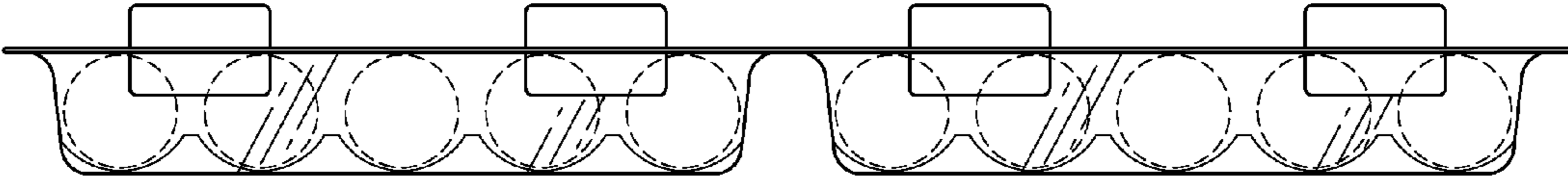

FIG. 7

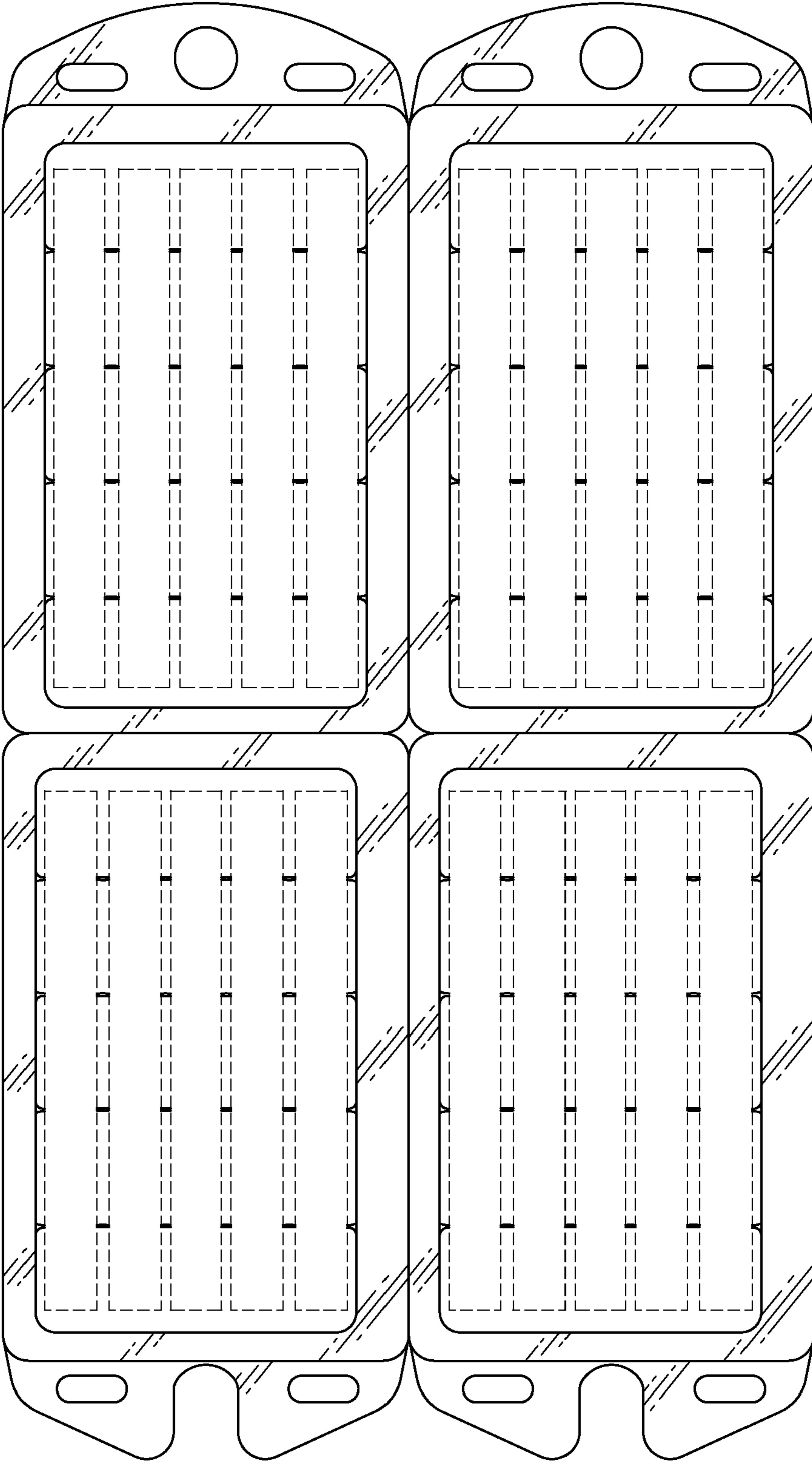

FIG. 8

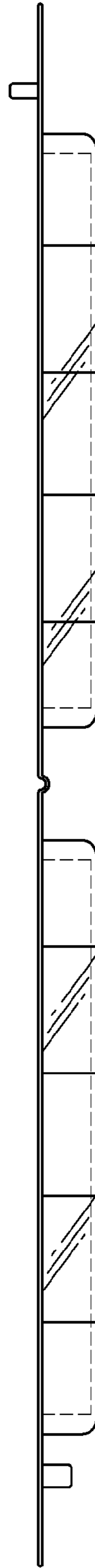

FIG. 9

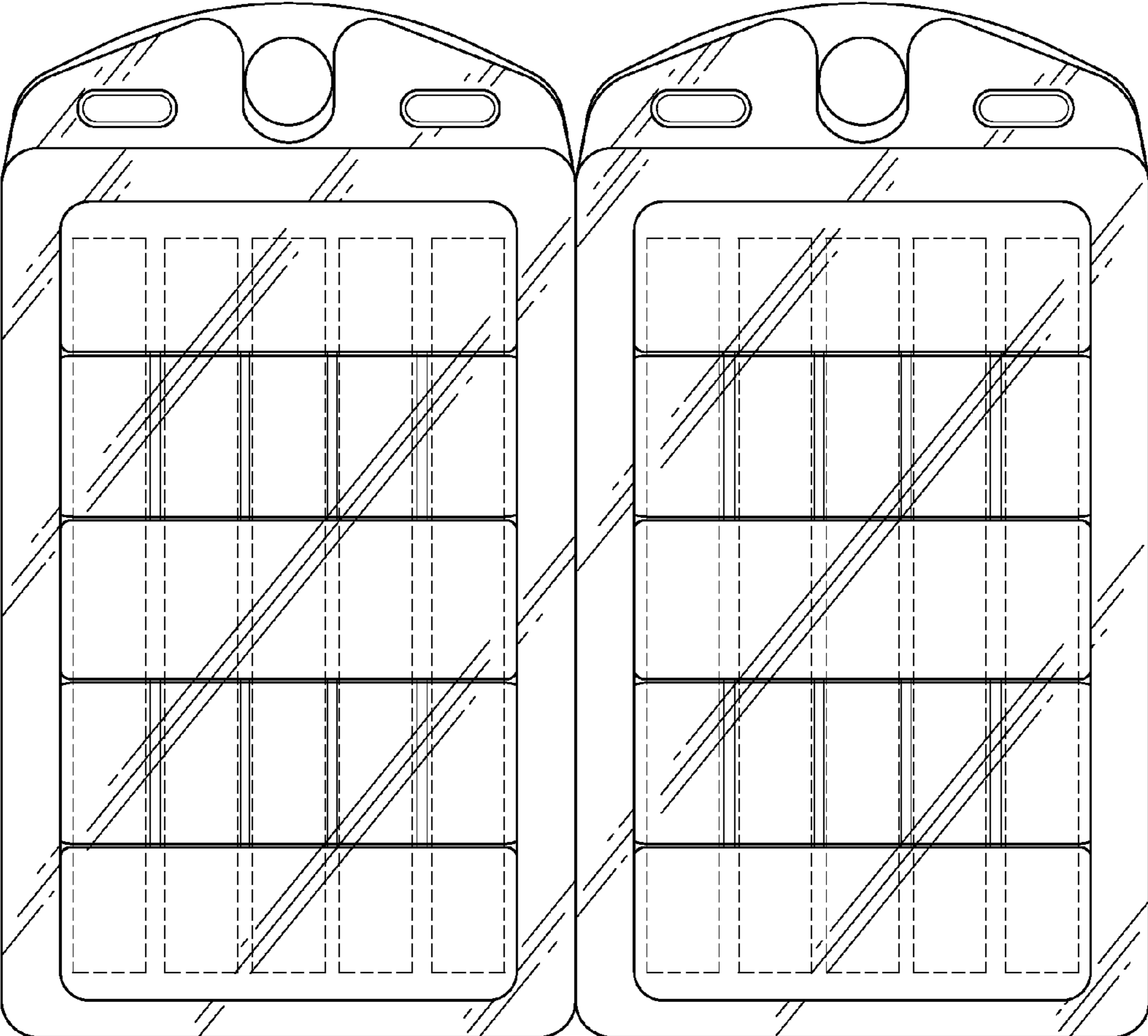

FIG. 10

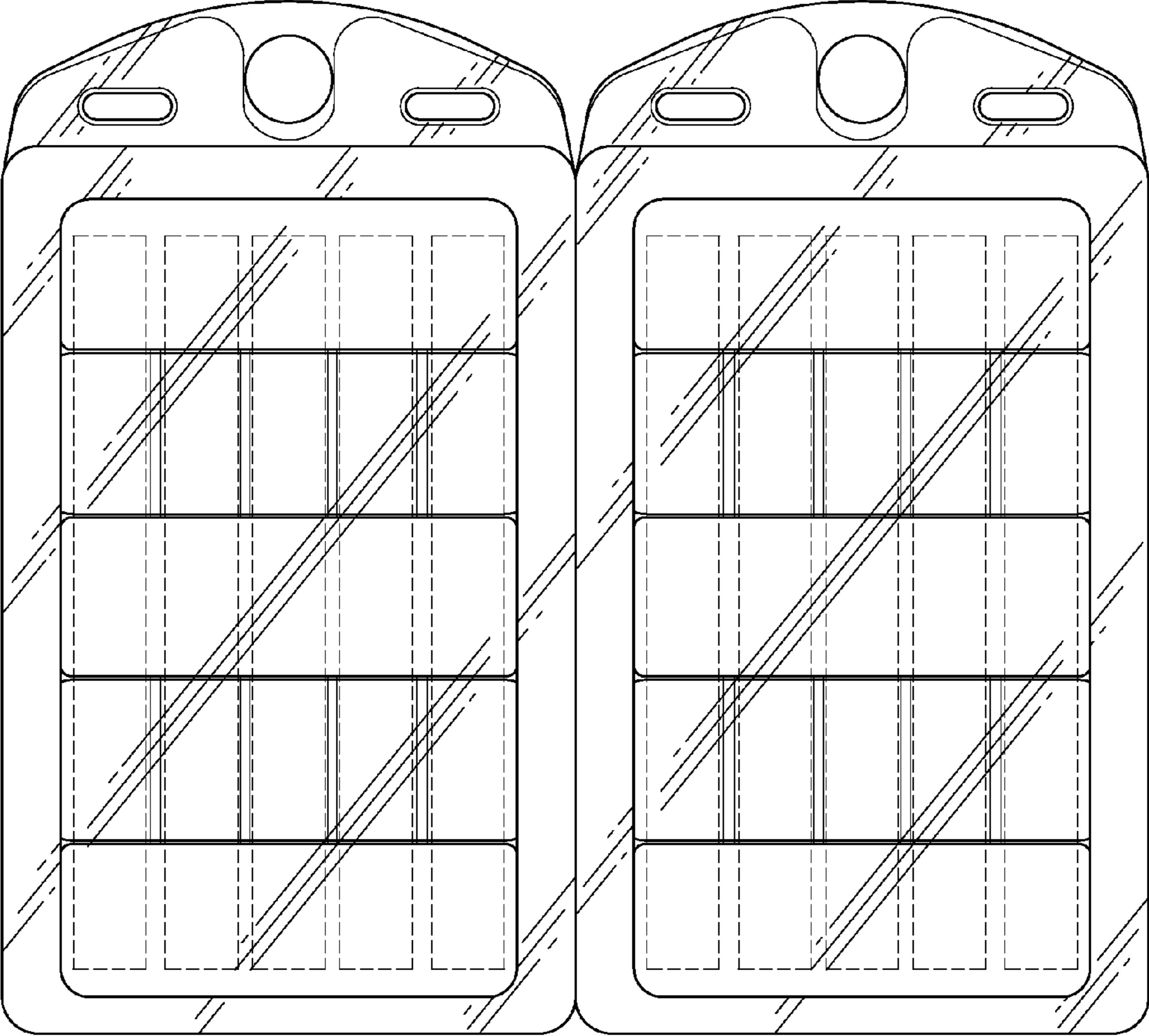

FIG. 11

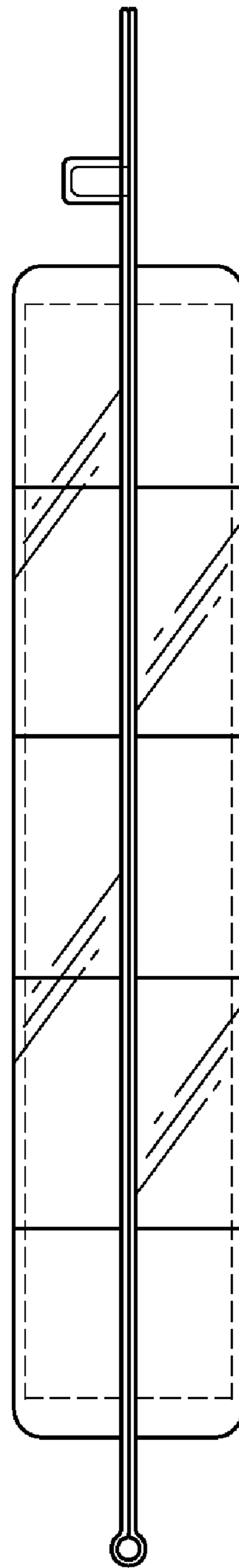

FIG. 12

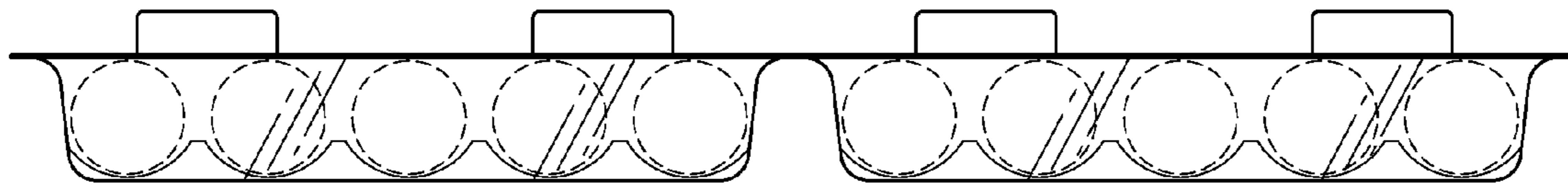

FIG. 13

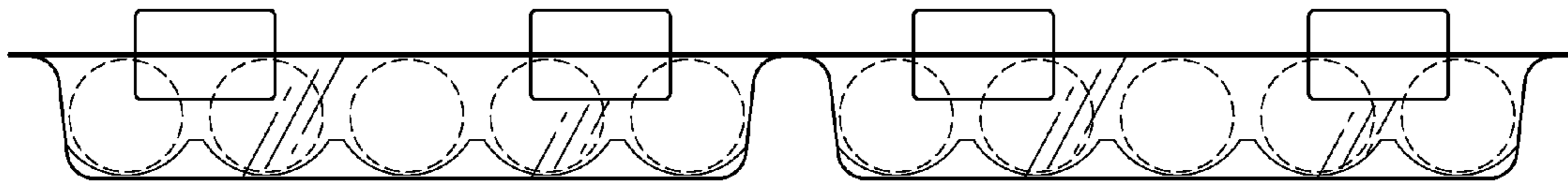

FIG. 14