

US00D599557S

(12) **United States Design Patent**  
**Crossman**

(10) **Patent No.:** **US D599,557 S**

(45) **Date of Patent:** **\*\* Sep. 8, 2009**

(54) **TOOTH CLEANING DEVICE**

D489,490 S \* 5/2004 Chodorow ..... D28/68  
D532,934 S \* 11/2006 Crossman ..... D28/65

(75) Inventor: **Scott P. Crossman**, Rockford, MI (US)

\* cited by examiner

(73) Assignee: **Ranir, LLC**, Grand Rapids, MI (US)

*Primary Examiner*—Melanie H Tung

*Assistant Examiner*—Lavone D Tabor

(\*\*) Term: **14 Years**

(74) *Attorney, Agent, or Firm*—Warner Norcross & Judd LLP

(21) Appl. No.: **29/334,859**

(57) **CLAIM**

(22) Filed: **Apr. 3, 2009**

The ornamental design for a tooth cleaning device, as shown and described.

(51) **LOC (9) Cl.** ..... **04-02**

(52) **U.S. Cl.** ..... **D4/108; D4/136**

(58) **Field of Classification Search** ..... D4/104–112,  
D4/116, 134, 136, 138; D28/66, 68; 132/308–311,  
132/323; 15/167.1, 167.2, 188, 143.1, 186,  
15/187; 601/139, 141

See application file for complete search history.

**DESCRIPTION**

FIG. 1 is a perspective view of the tooth cleaning device embodying the new design;

FIG. 2 is a right side view thereof;

FIG. 3 is a left side view thereof;

FIG. 4 is a front view thereof;

FIG. 5 is a rear view thereof;

FIG. 6 is a top view thereof;

FIG. 7 is a bottom view thereof; and,

FIG. 8 is a close up view of a head portion of the tooth cleaning device.

FIGS. 1–7 show a strand of dental floss in phantom lines. The portions shown in phantom lines form no part of the claimed design.

(56) **References Cited**

**U.S. PATENT DOCUMENTS**

1,488,214	A *	3/1924	Mason	.....	132/324
D161,873	S *	2/1951	Rosengard	.....	D4/111
D191,821	S *	11/1961	Mitchell	.....	D4/108
3,589,823	A *	6/1971	Hendrickson	.....	401/176
D221,948	S *	9/1971	Centofanti	.....	D28/68
D240,341	S *	6/1976	Najjar	.....	D4/108
D315,988	S *	4/1991	Tanaka	.....	D4/108
5,184,719	A *	2/1993	Gordon	.....	206/209.1
D373,250	S *	9/1996	Cavazza	.....	D4/104
D436,734	S *	1/2001	Van Gelder	.....	D4/104

**1 Claim, 5 Drawing Sheets**

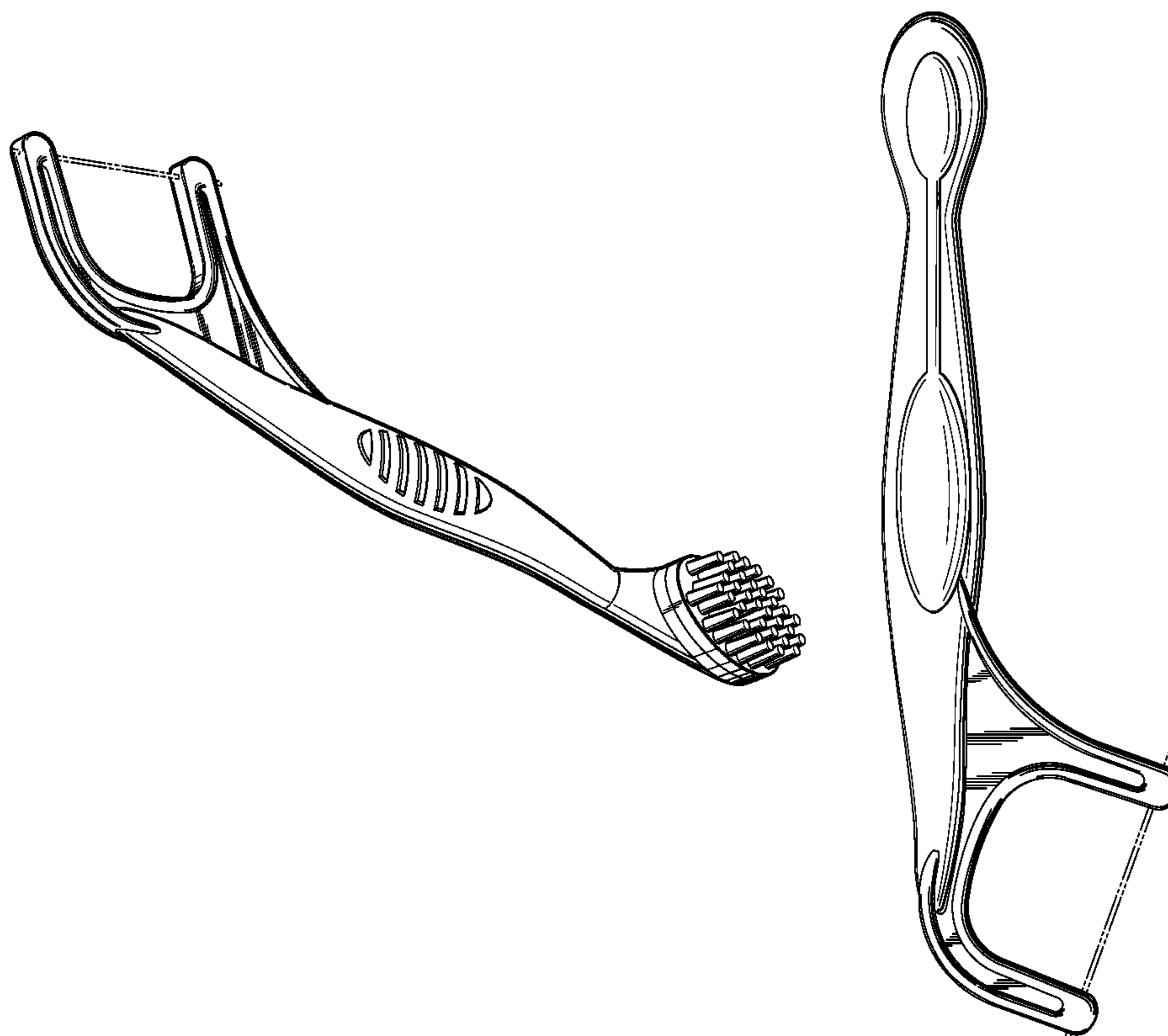

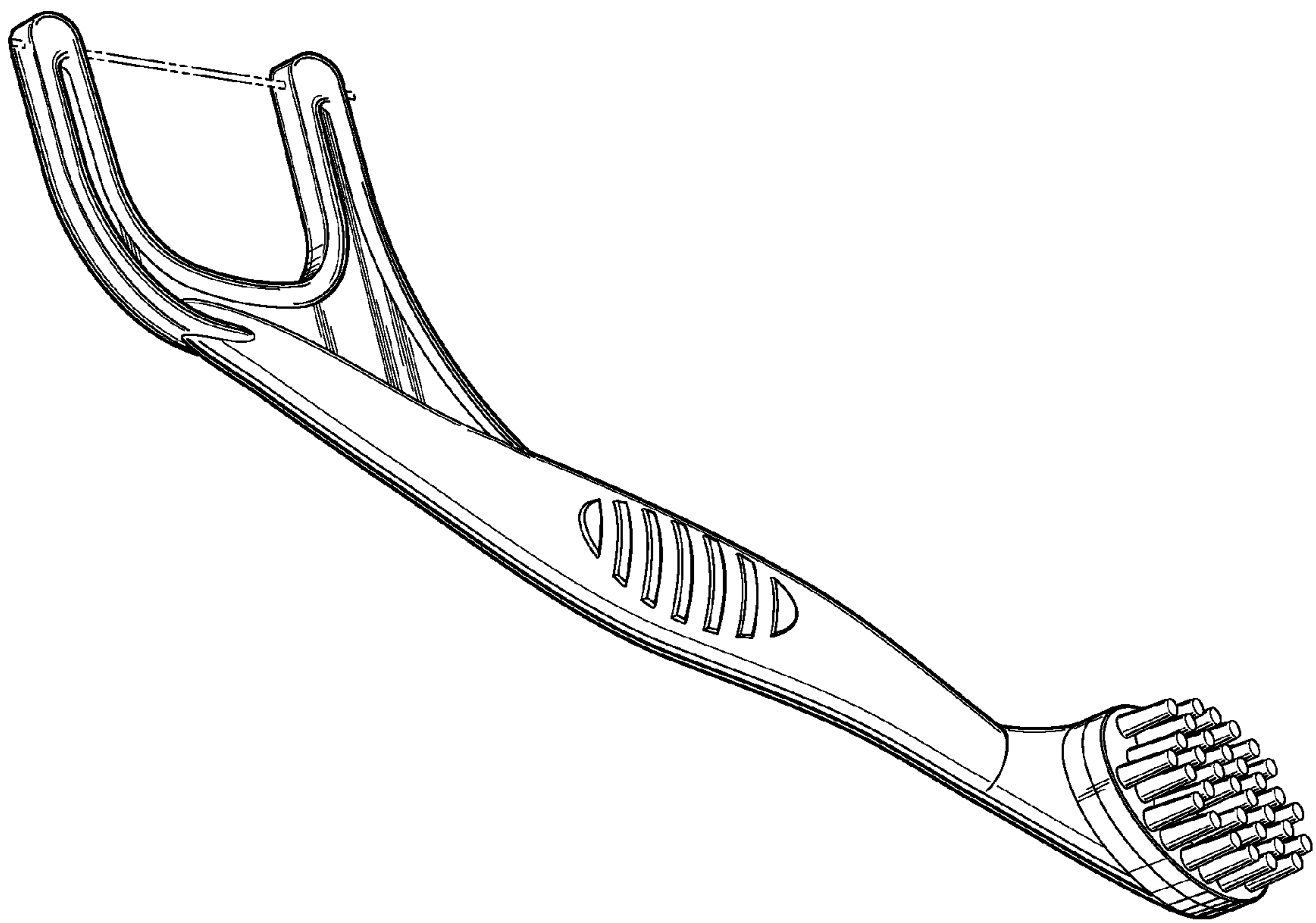

Fig. 1

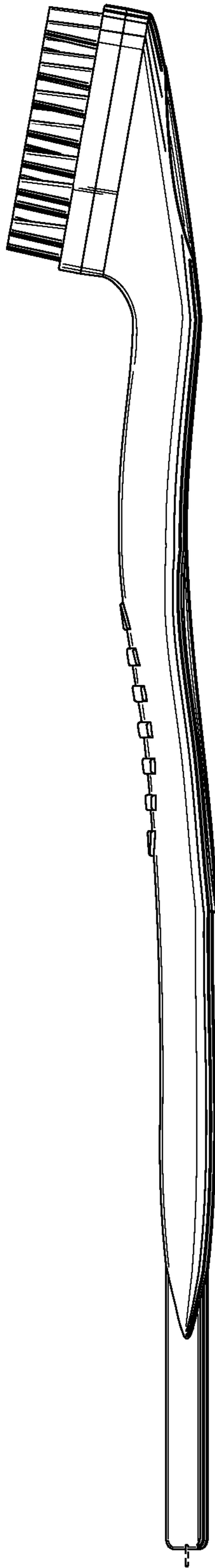

Fig. 2

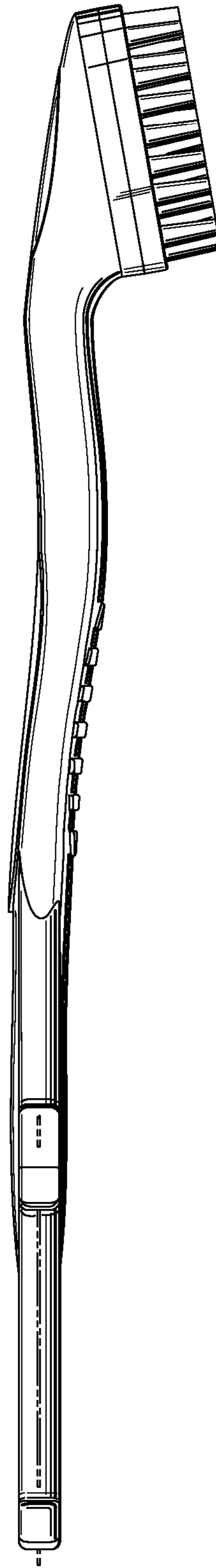

Fig. 3

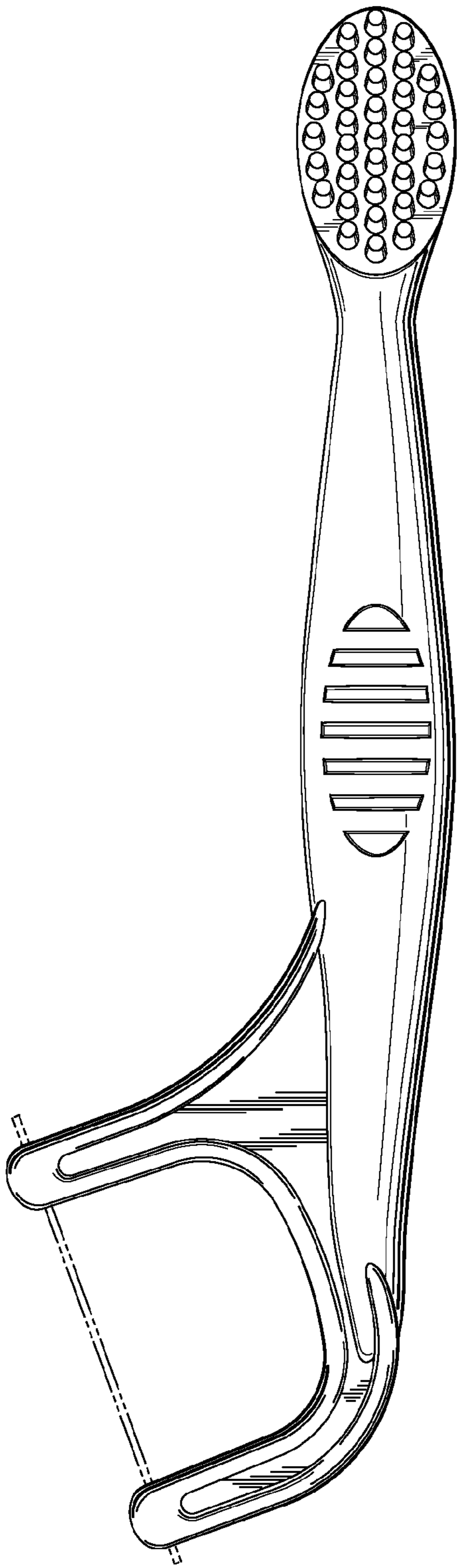

Fig. 4

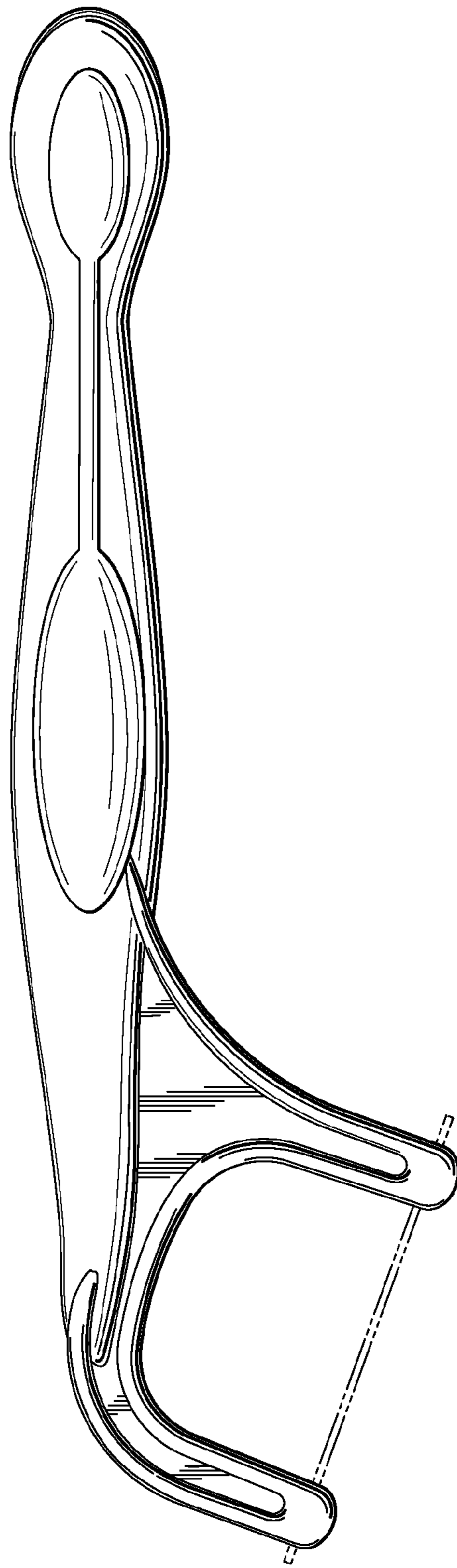

Fig. 5

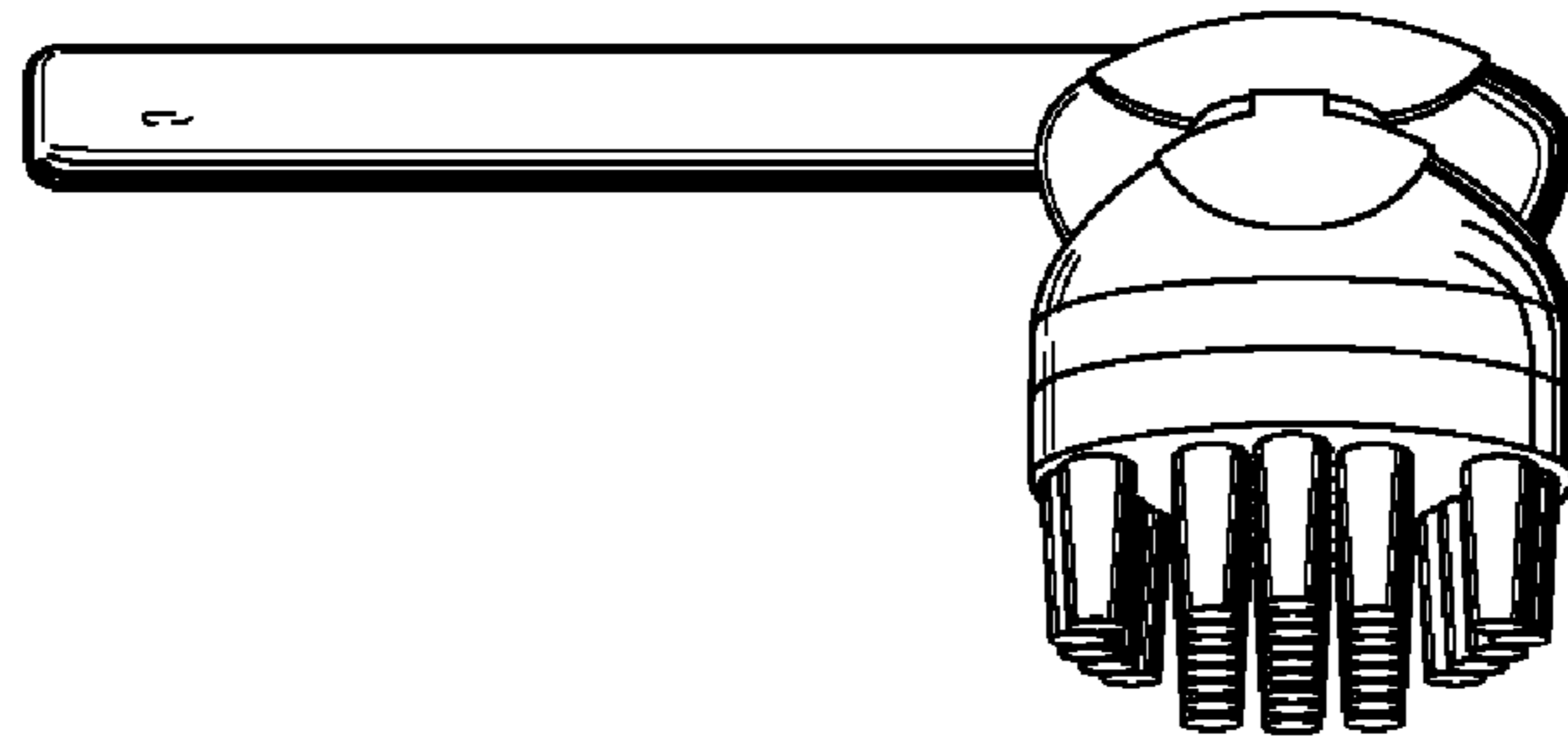

Fig. 6

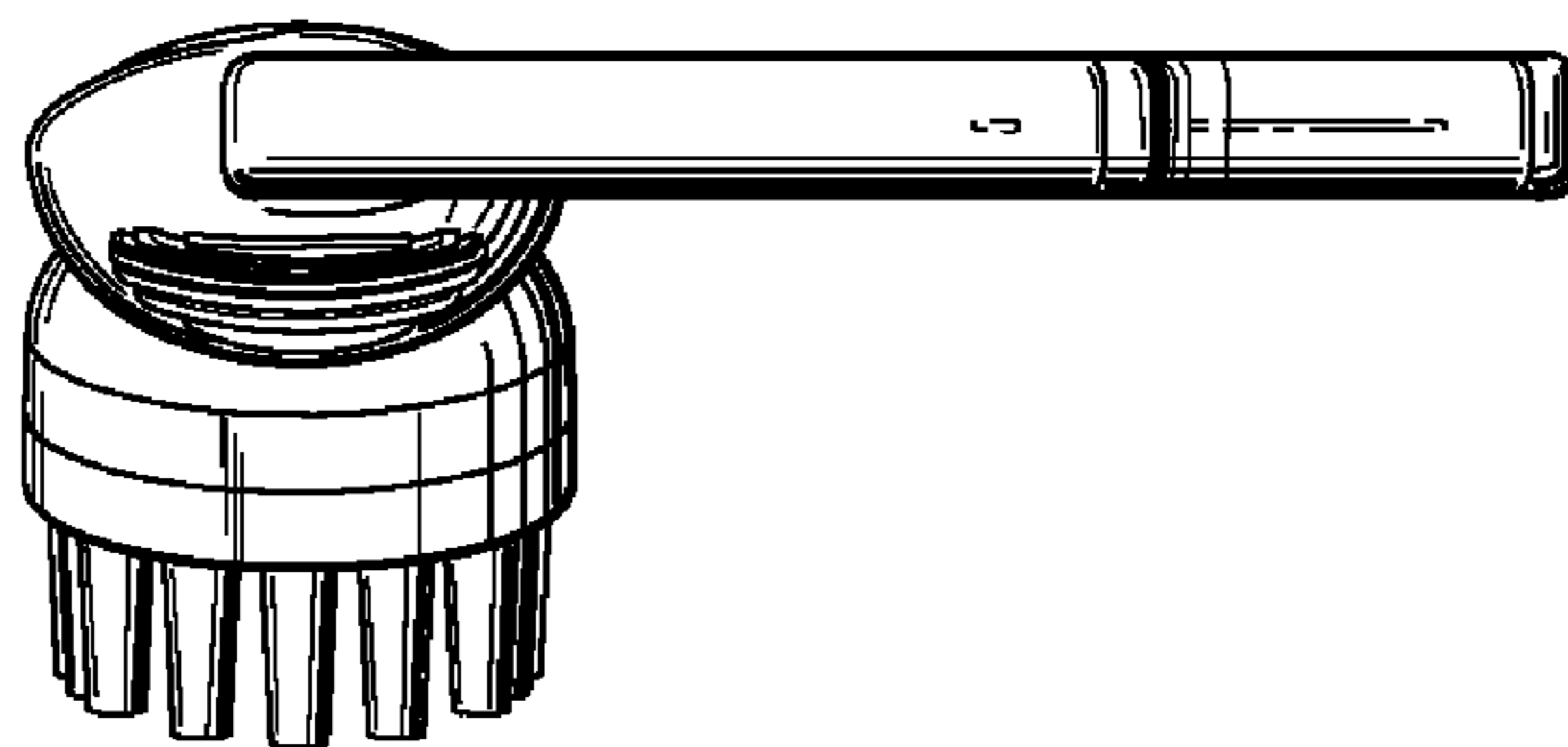

Fig. 7

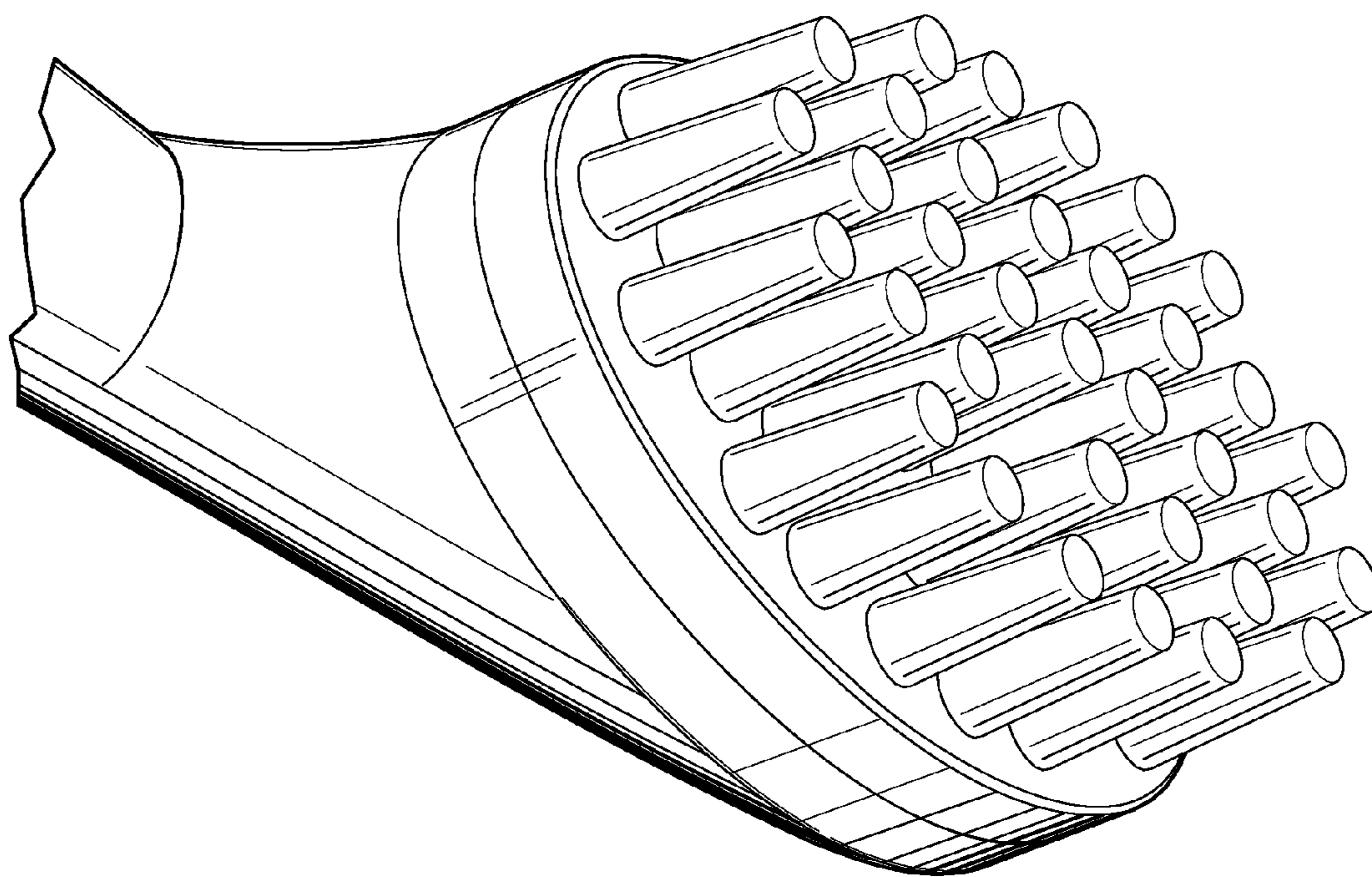

Fig. 8