



US00D599553S

(12) **United States Design Patent**
Shapiro

(10) **Patent No.:** **US D599,553 S**
(45) **Date of Patent:** **** Sep. 8, 2009**

(54) **SET OF FEET FOR A HANDBAG**

(57) **CLAIM**

(76) **Inventor:** **Kathy Shapiro**, 2 Atlantic Ct., Marlboro, NJ (US) 07746

The ornamental design for a set of feet for a handbag, as shown and described.

(**) **Term:** **14 Years**

DESCRIPTION

(21) **Appl. No.:** **29/295,865**

FIG. 1 is a front perspective view of an embodiment of feet for a handbag showing a design of my invention;

(22) **Filed:** **Oct. 9, 2007**

FIG. 2 is an enlarged perspective view of one of the feet for a handbag shown in FIG. 1, each foot having an identical appearance;

(51) **LOC (9) Cl.** **03-01**

(52) **U.S. Cl.** **D3/318; D3/324**

(58) **Field of Classification Search** **D3/232-234, D3/238, 240-246, 318, 322, 324; D11/83; 150/100, 103-104, 107-110, 118-119**

FIG. 3 is a right side view of the foot for a handbag shown in FIG. 2, the left side being a mirror image of the right side;

See application file for complete search history.

FIG. 4 is a top view of the foot for a handbag shown in FIG. 2;

(56) **References Cited**

U.S. PATENT DOCUMENTS

D189,082 S *	10/1960	Goodman	D2/899
D224,183 S *	7/1972	Straub et al.	D2/899
D259,296 S *	5/1981	Meyer	D2/899
D375,625 S	11/1996	Kieselstein-Cord		
D521,727 S *	5/2006	Albini	D3/238

FIG. 5 is a bottom view of the foot for a handbag shown in FIG. 2;

FIG. 6 a front view of the foot for a handbag shown in FIG. 2; and,

FIG. 7 a rear view of the foot for a handbag shown in FIG. 2.

All broken-lines appearing in the drawings are for illustrative purposes only and form no part of the claimed design.

One of the feet in the set has been shown detached for ease and clarity of illustration.

* cited by examiner

Primary Examiner—Holly H Baynham

(74) *Attorney, Agent, or Firm*—Volpe and Koenig, P.C.

1 Claim, 4 Drawing Sheets

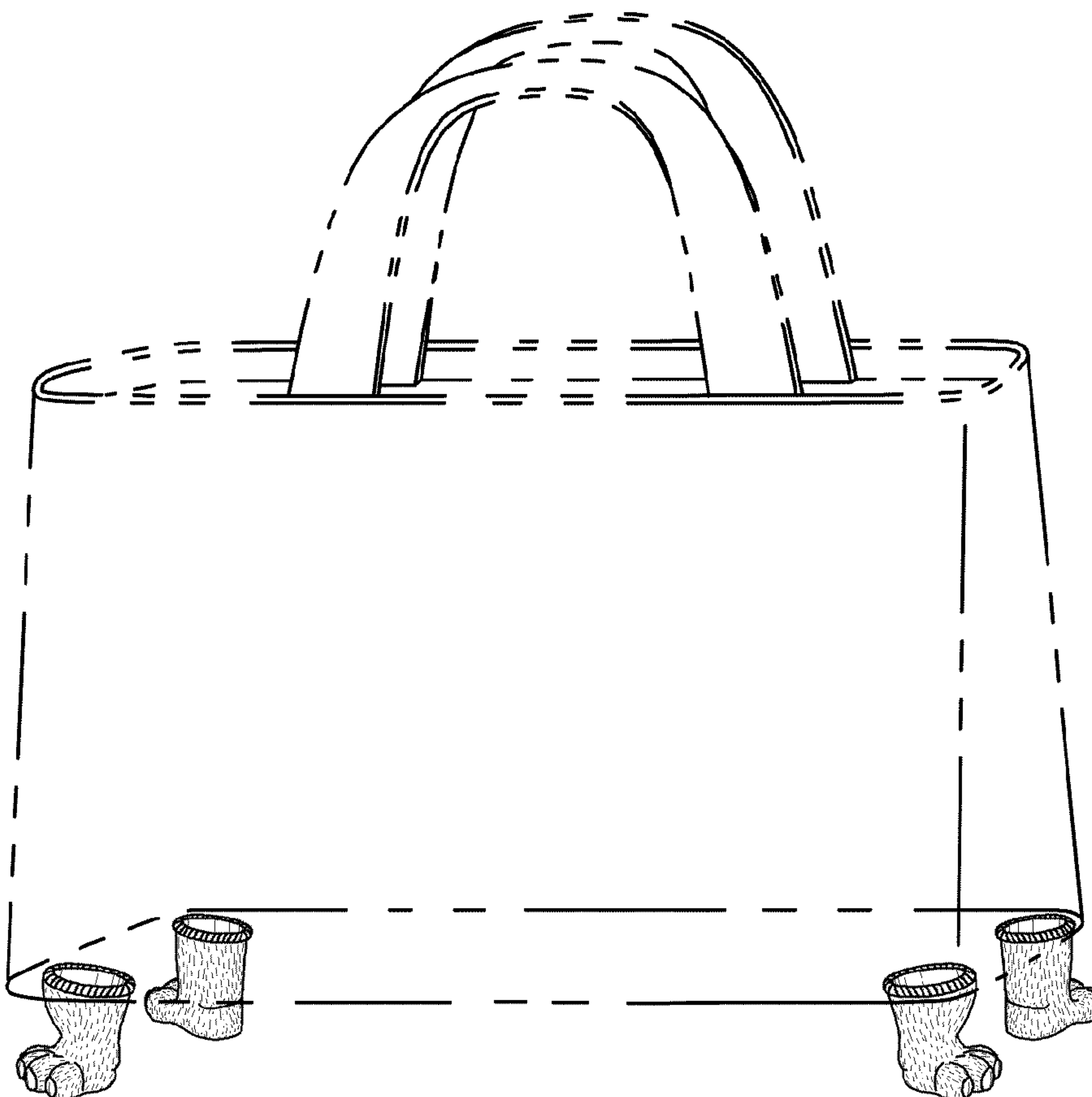

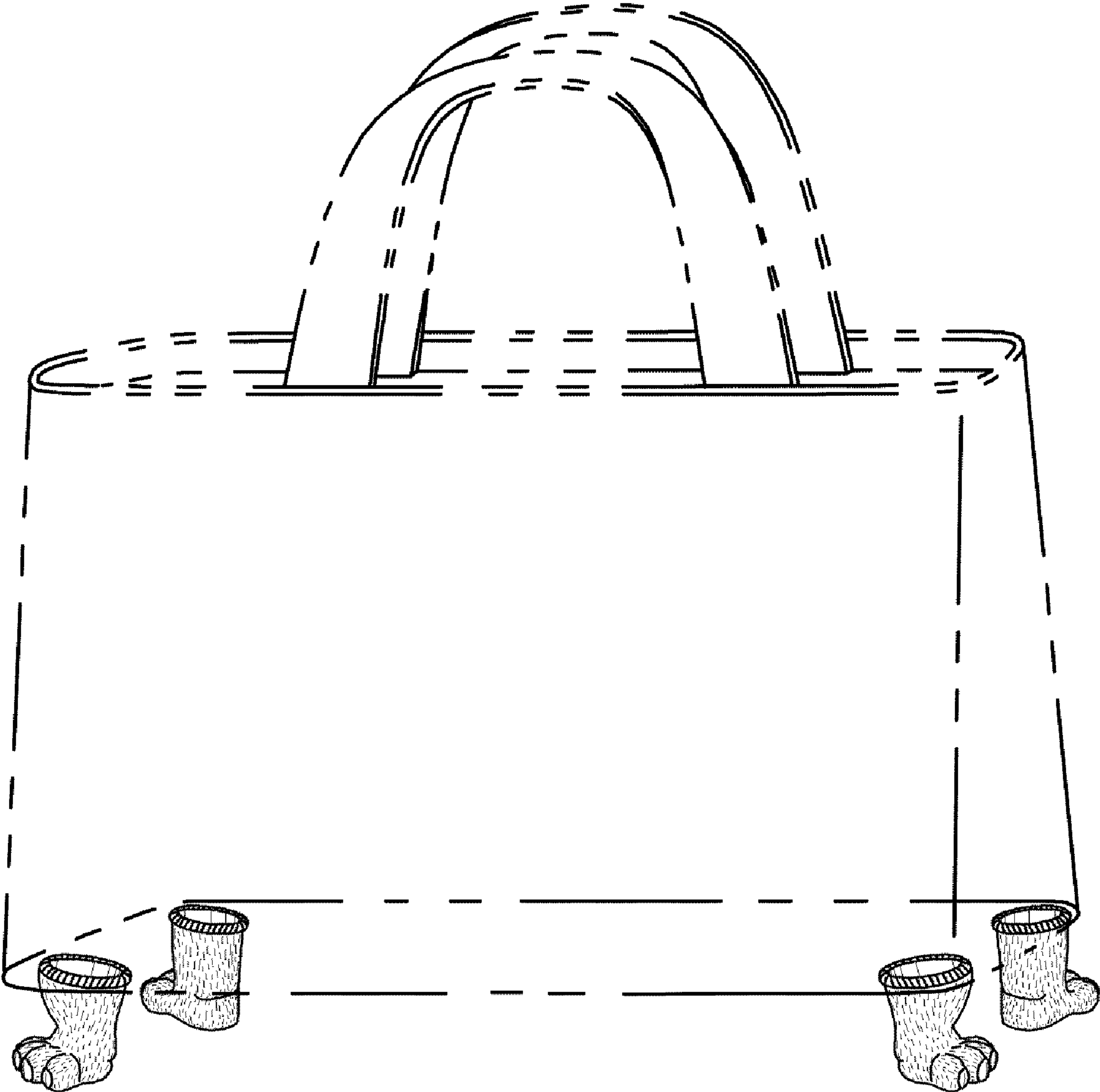

FIG. 1

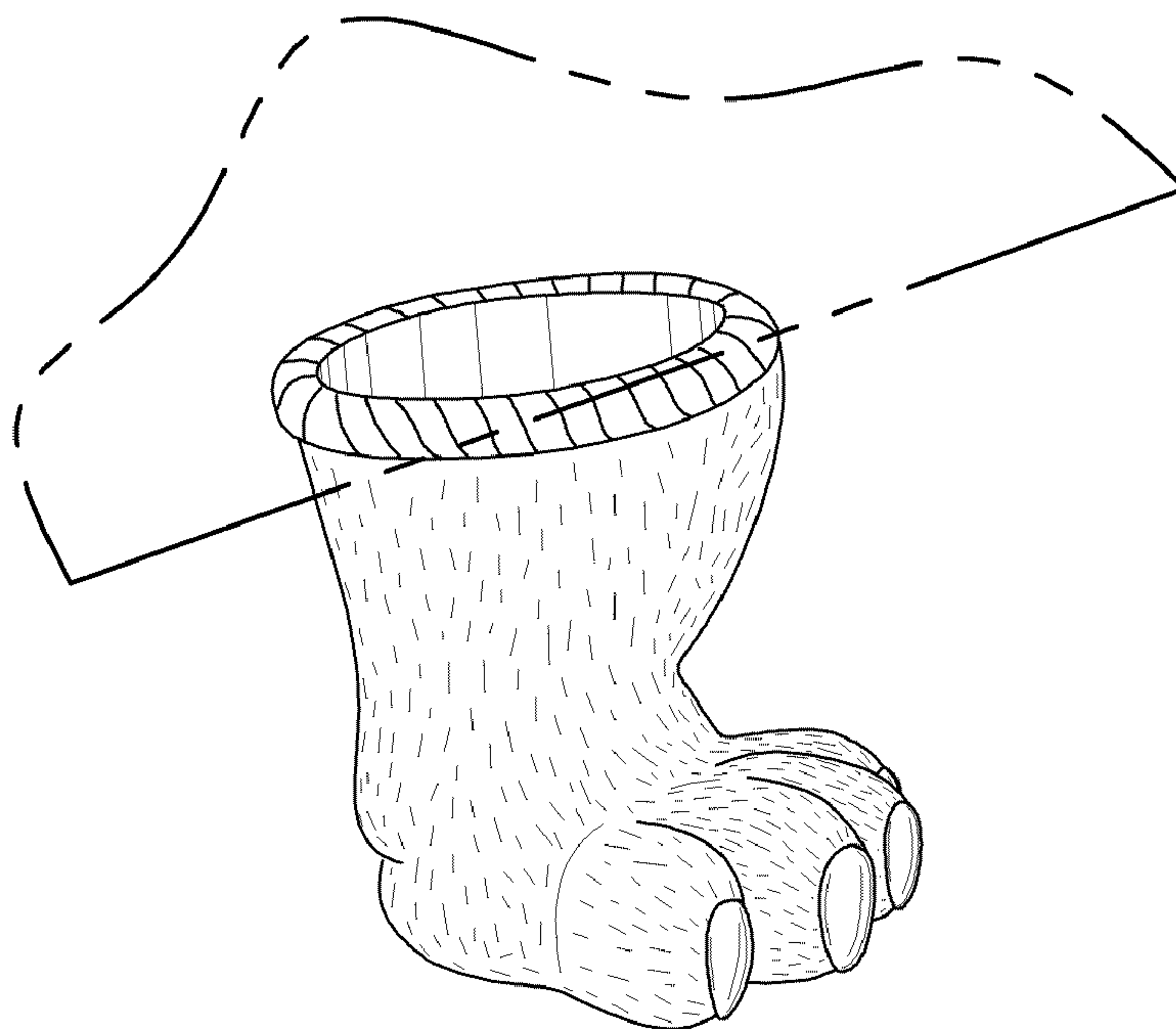

FIG. 2

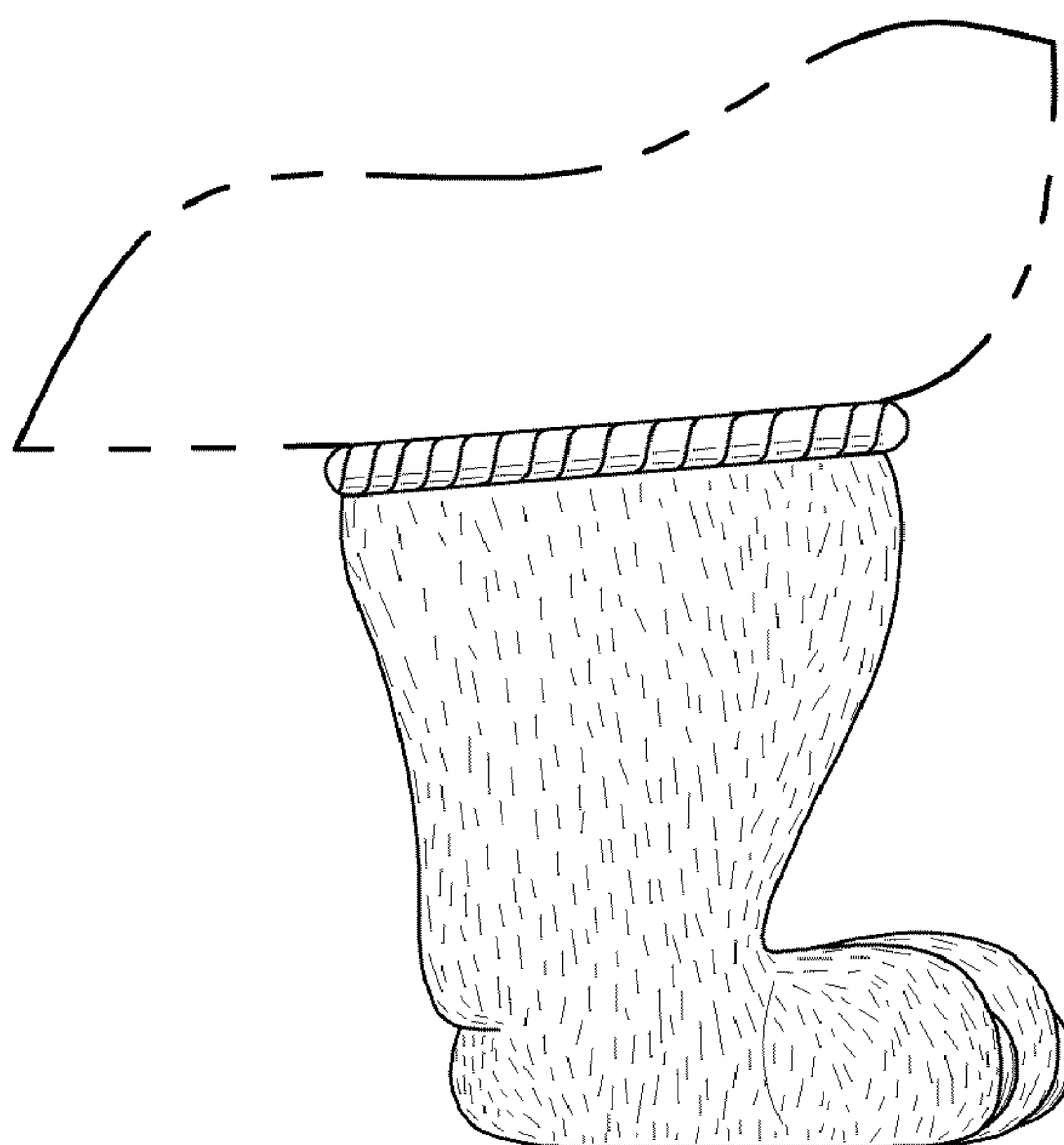

FIG. 3

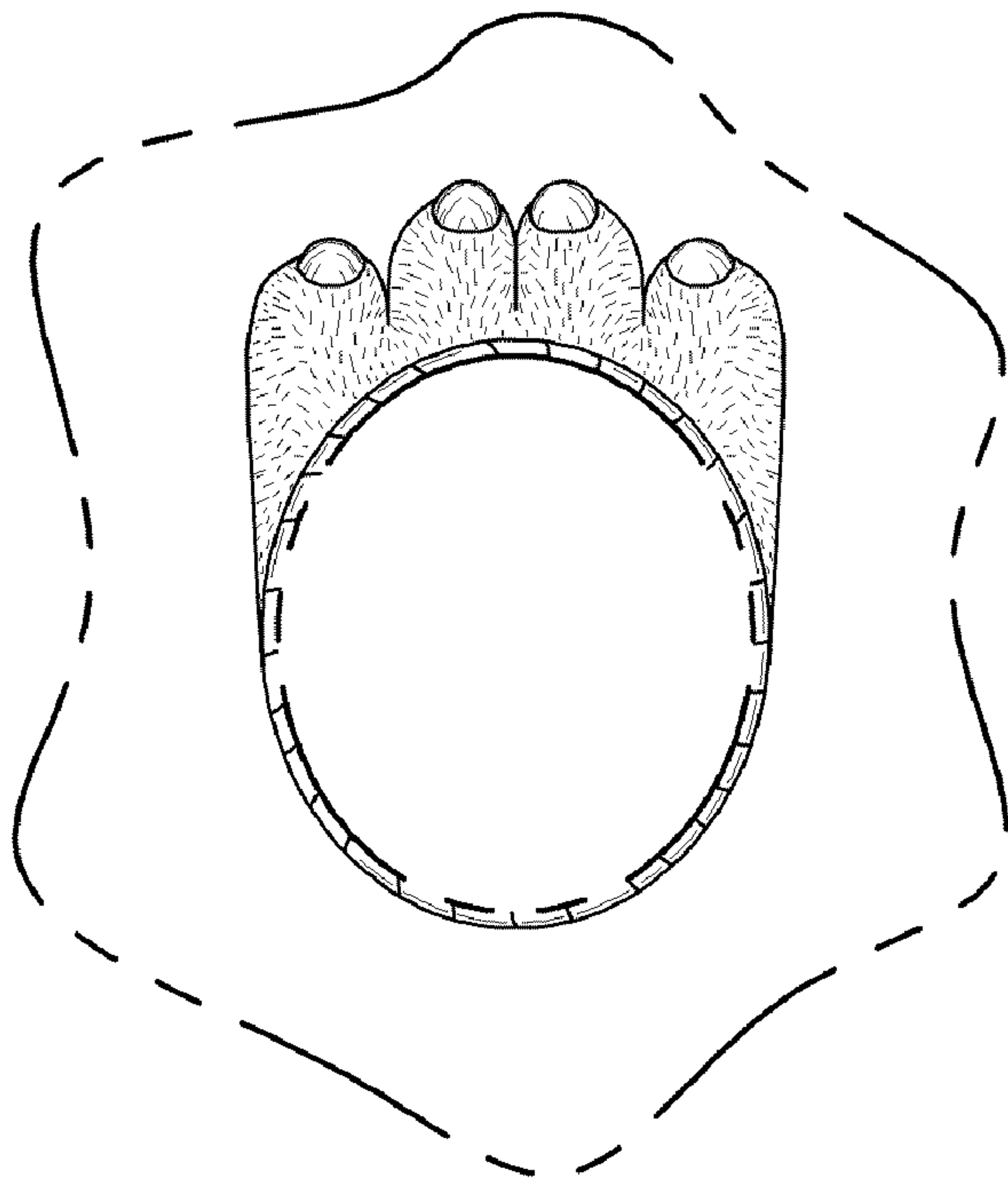

FIG. 4

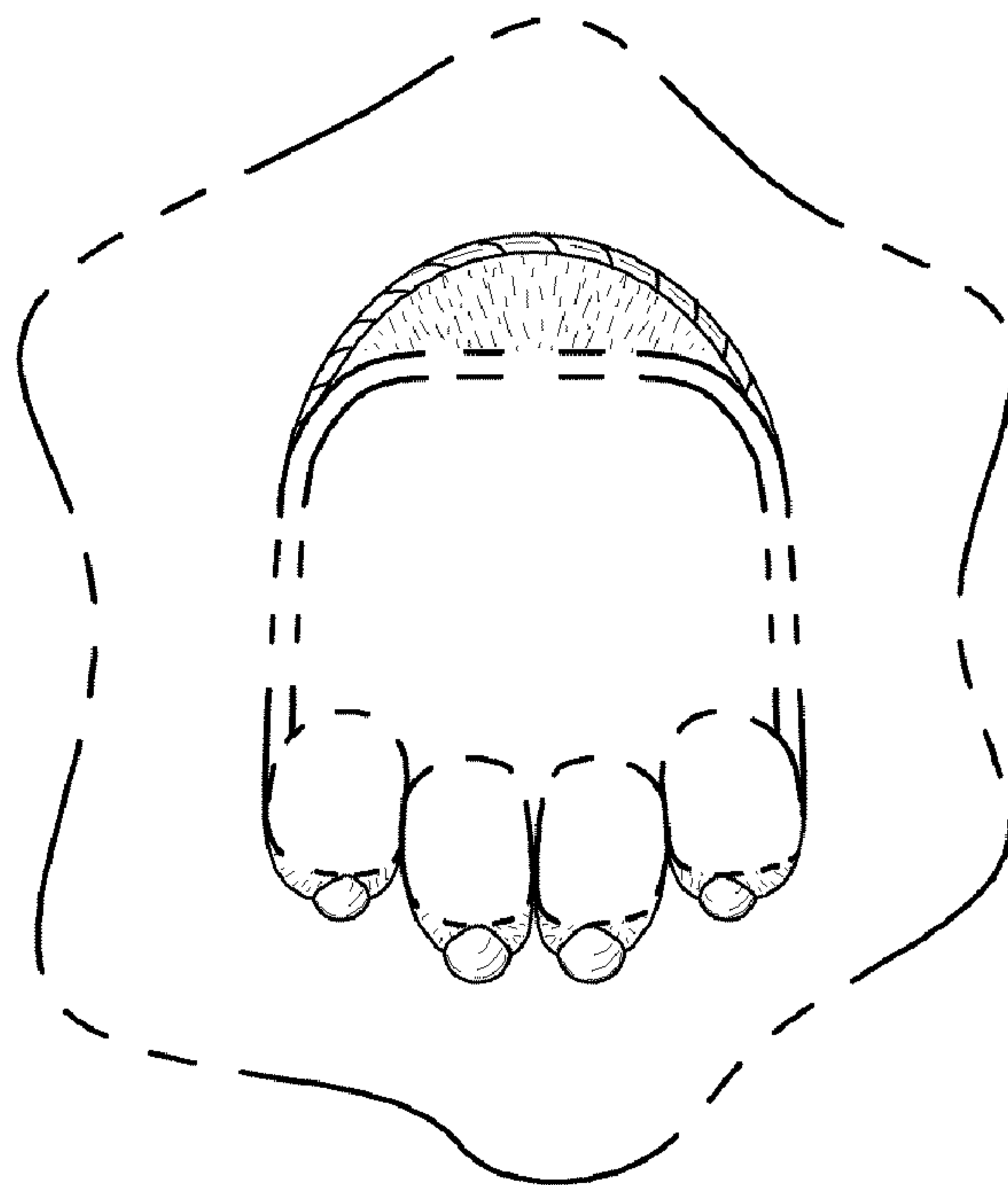

FIG. 5

FIG. 6

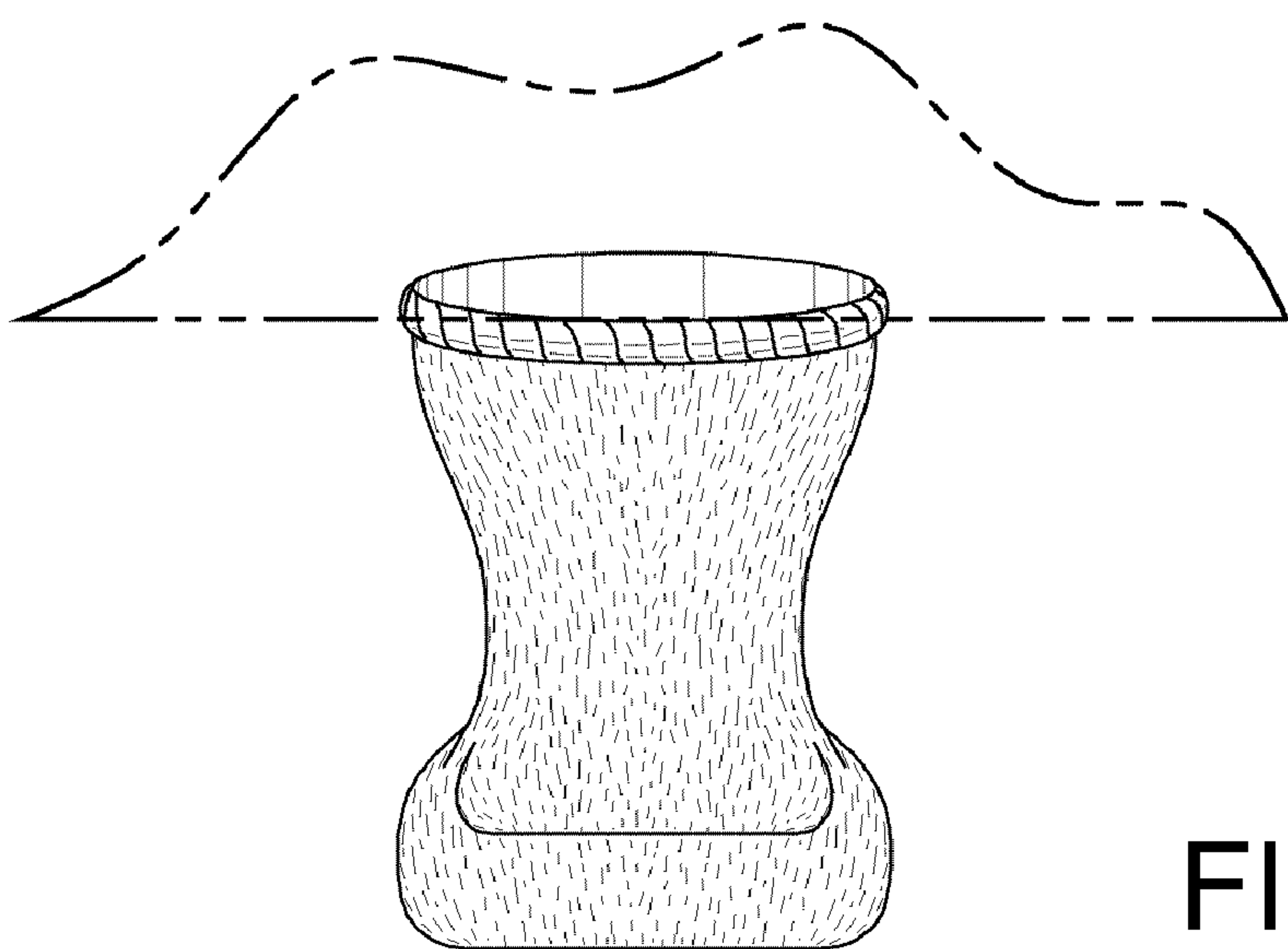
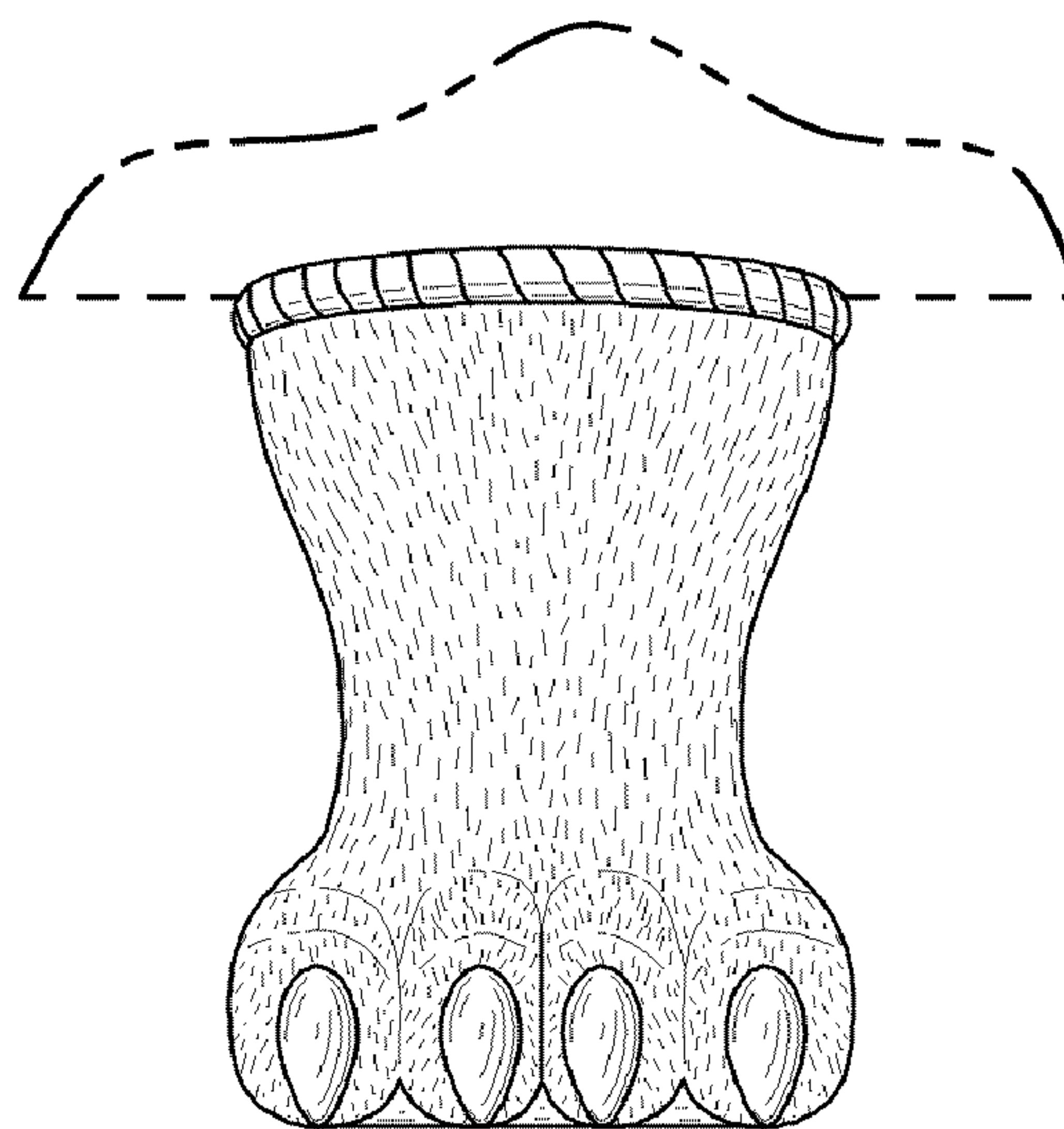

FIG. 7