



US00D599508S

(12) **United States Design Patent**
Choi et al.

(10) **Patent No.:** **US D599,508 S**

(45) **Date of Patent:** **** Sep. 1, 2009**

(54) **WASHING MACHINE**

D564,145 S * 3/2008 Kim D32/6
D582,106 S * 12/2008 Kim et al. D32/6

(75) Inventors: **Hyoung Sub Choi**, Seoul (KR); **Gyoo Sang Choi**, Seoul (KR); **Sang Ho Park**, Kyungki-do (KR); **Jeong Min Kim**, Seoul (KR); **Chan Young Lee**, Seoul (KR); **Dong Won Chun**, Kyunggi-do (KR); **Jong Soo Jeon**, Gyeonggi-do (KR)

* cited by examiner

Primary Examiner—T. Chase Nelson
Assistant Examiner—Kathleen M Sims
(74) *Attorney, Agent, or Firm*—Ladas & Parry LLP

(73) Assignee: **Samsung Electronic Co., Ltd.**, Suwon, Kyungki-Do (KR)

(57) **CLAIM**

We claim the ornamental design for a washing machine, as shown and described.

(**) Term: **14 Years**

(21) Appl. No.: **29/330,416**

DESCRIPTION

(22) Filed: **Jan. 7, 2009**

(51) **LOC (9) Cl.** **15-05**

(52) **U.S. Cl.** **D32/6**

(58) **Field of Classification Search** D32/1,
D32/5, 6, 8; 68/3 R, 5 R, 12.01, 12.08; 34/523-524;
312/31; 38/1 A

See application file for complete search history.

FIG. 1 is a front, right side, top perspective view a Washing Machine showing our new design;
FIG. 2 is a front elevational view thereof;
FIG. 3 is a rear elevational view thereof;
FIG. 4 is a left side elevational view thereof;
FIG. 5 is a right side elevational view thereof;
FIG. 6 is a top plan view thereof; and,
FIG. 7 is a bottom plan view thereof.

(56) **References Cited**

U.S. PATENT DOCUMENTS

D564,144 S * 3/2008 Kwon D32/6

1 Claim, 6 Drawing Sheets

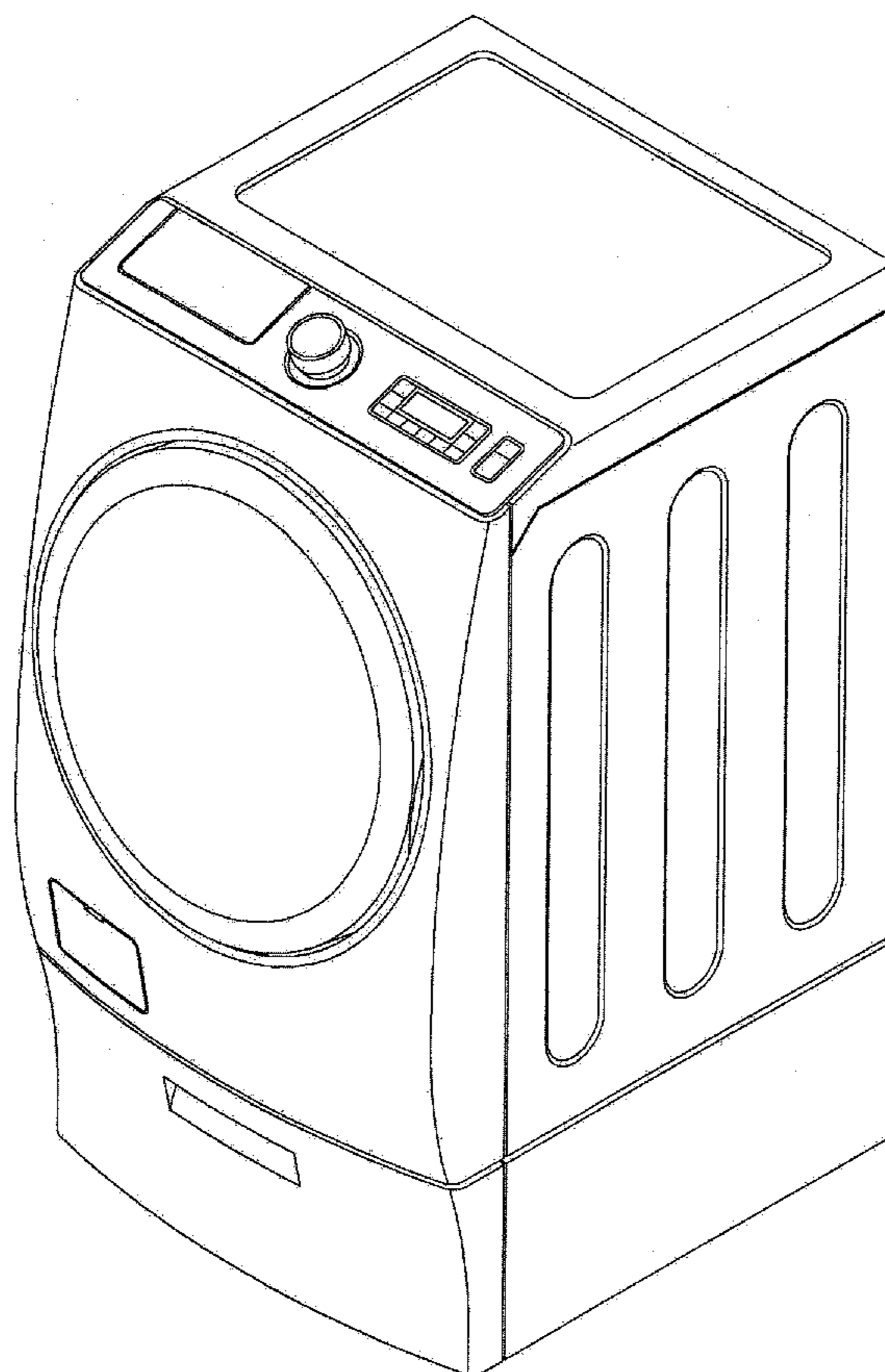

FIG. 1

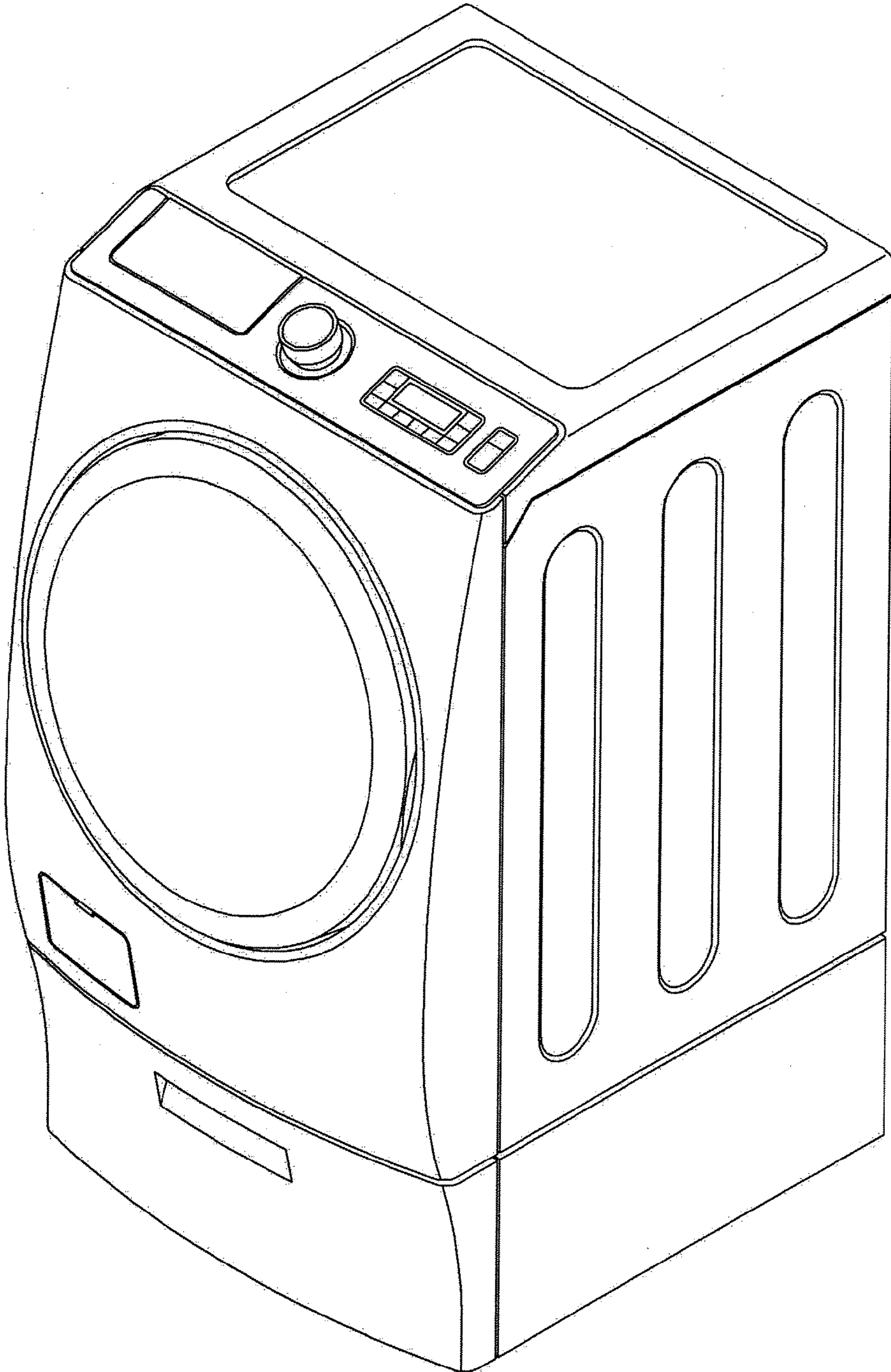

FIG. 2

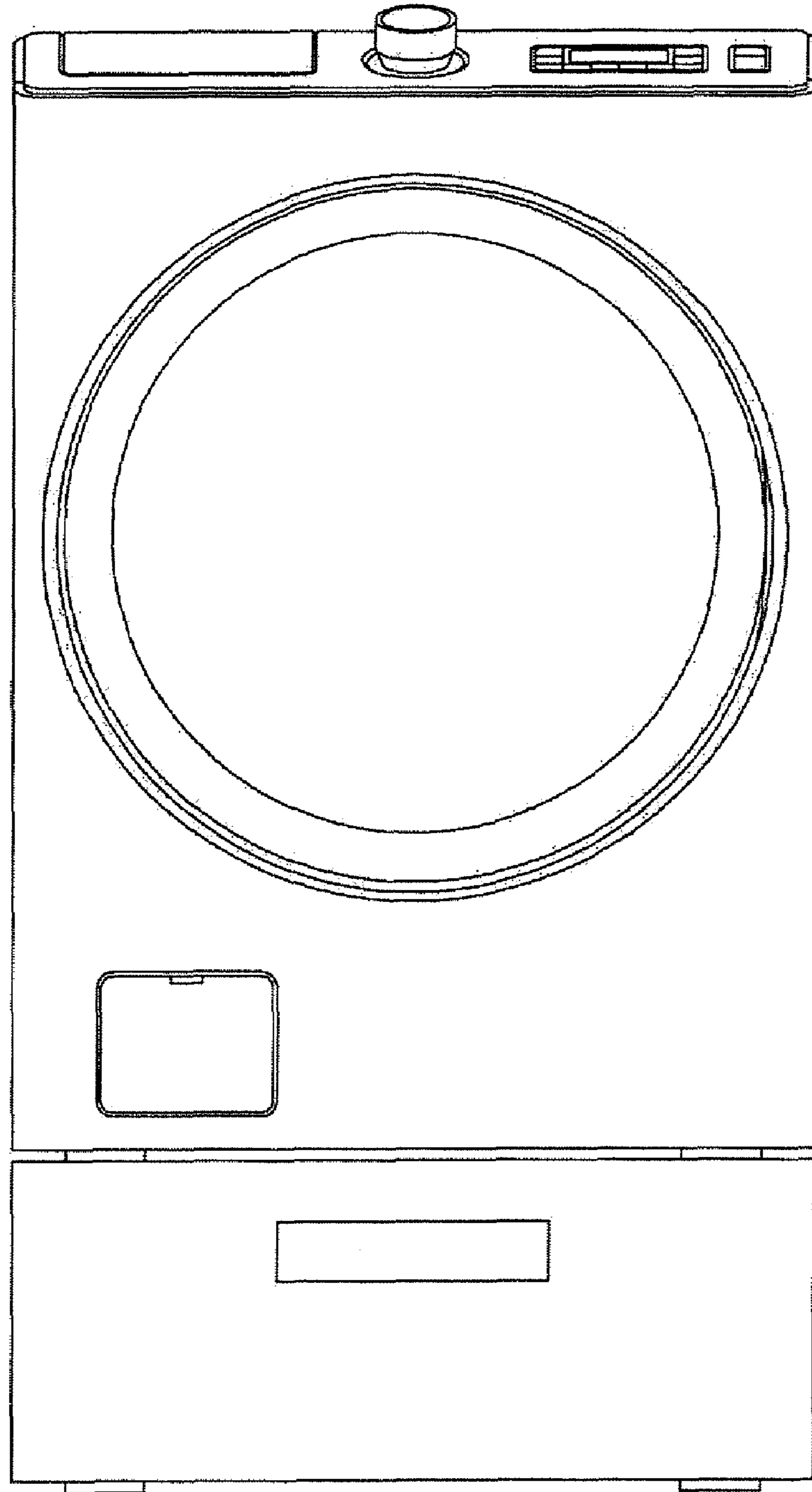

FIG. 3

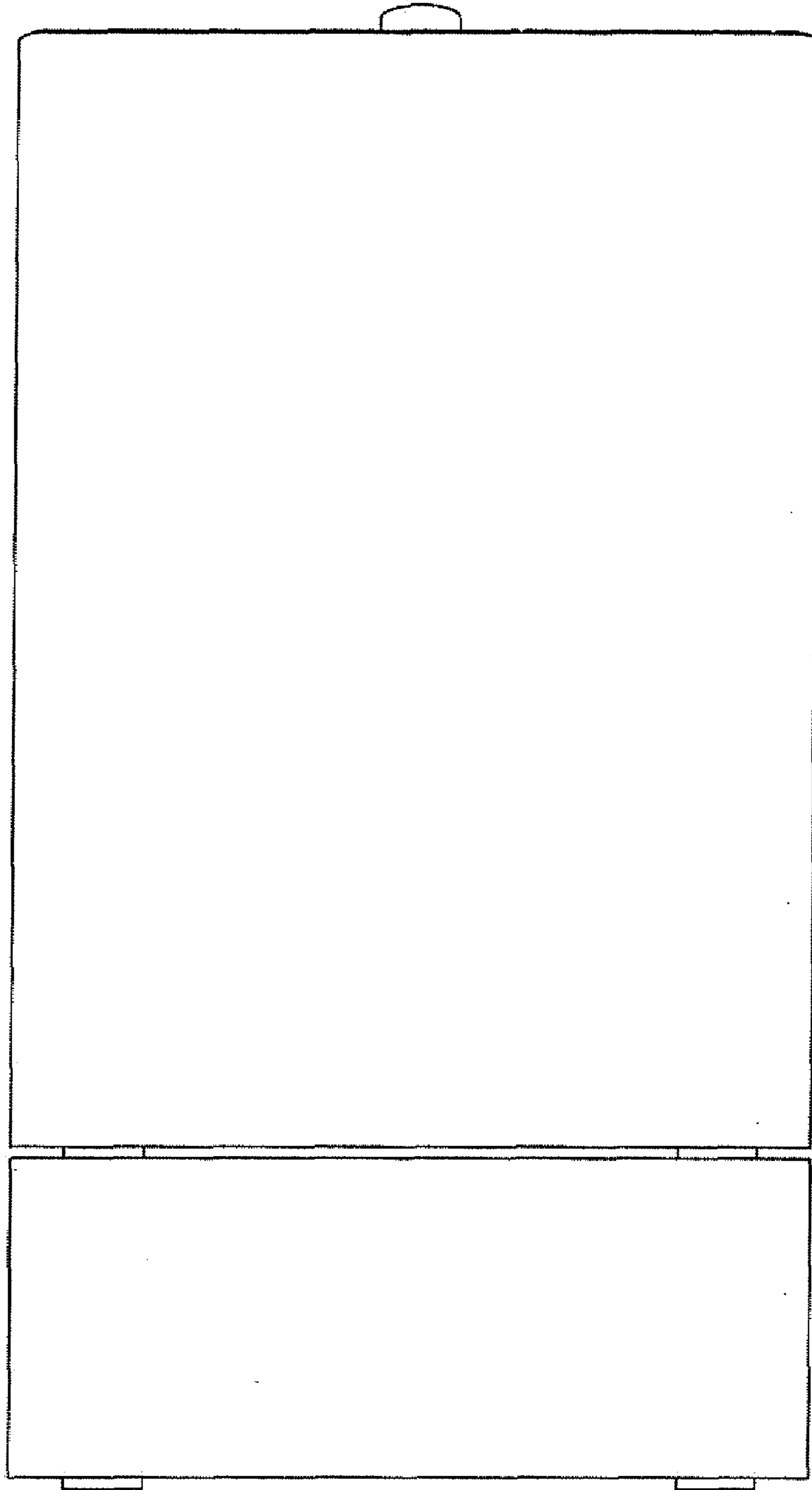

FIG. 4

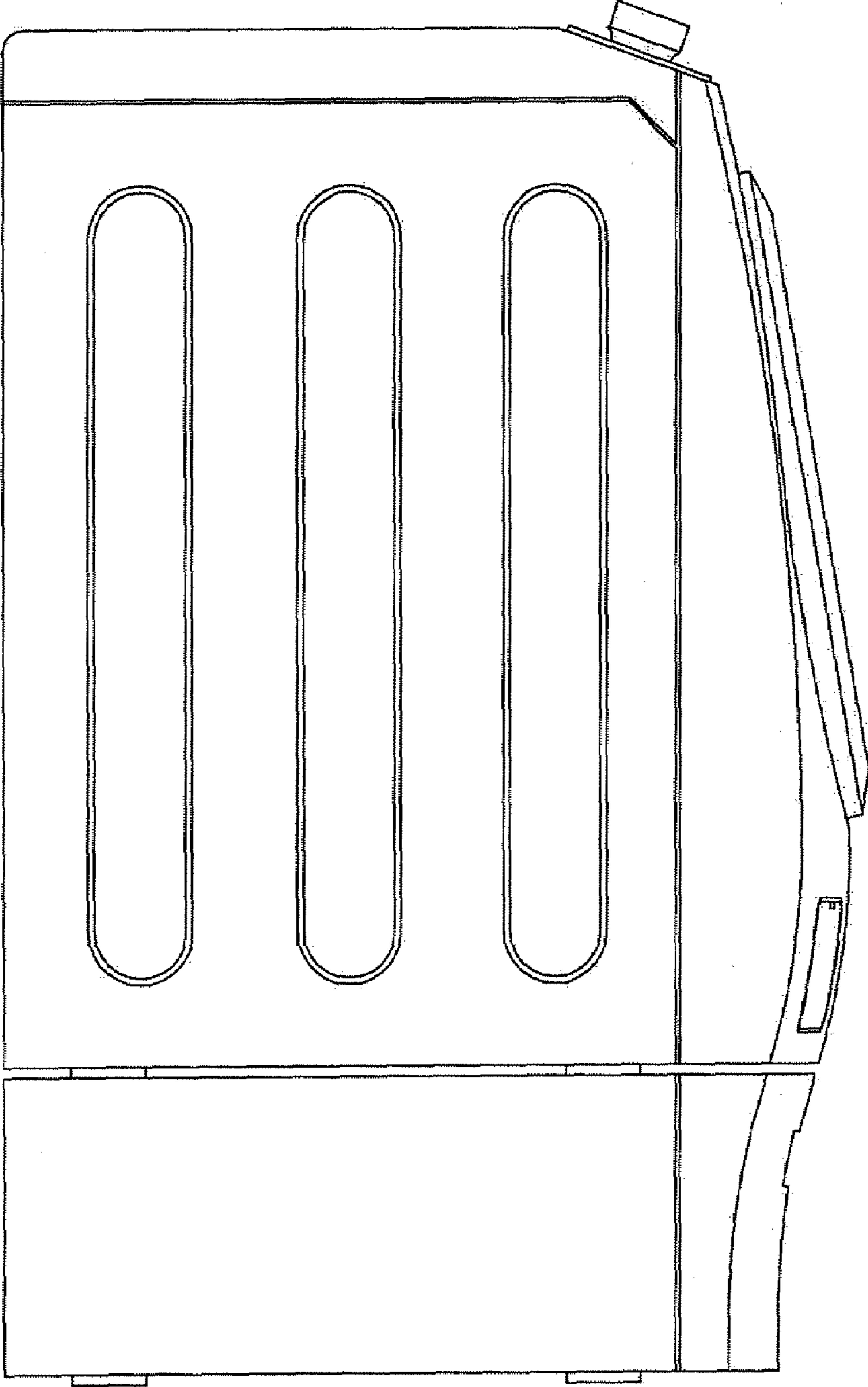

FIG. 5

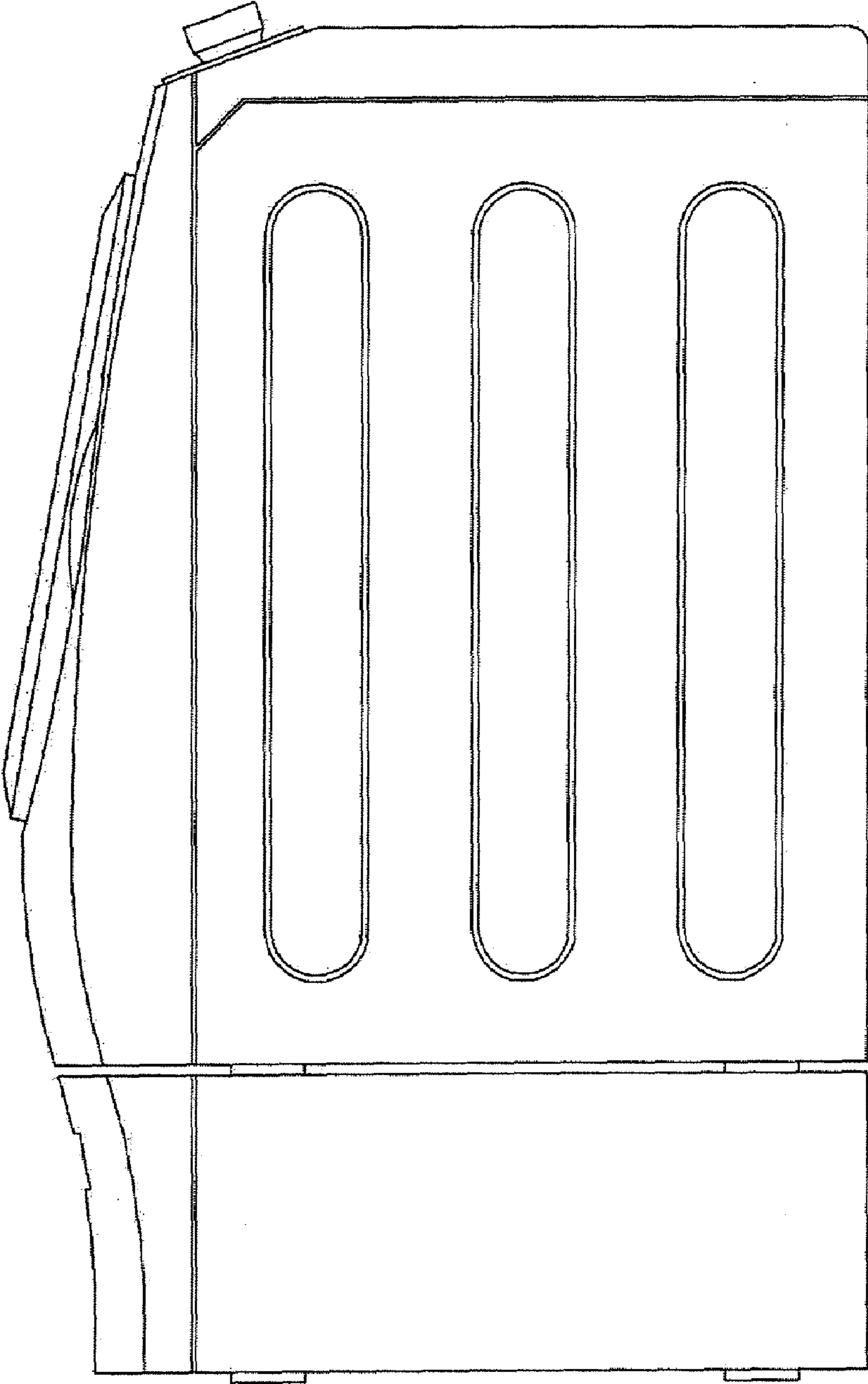

FIG. 6

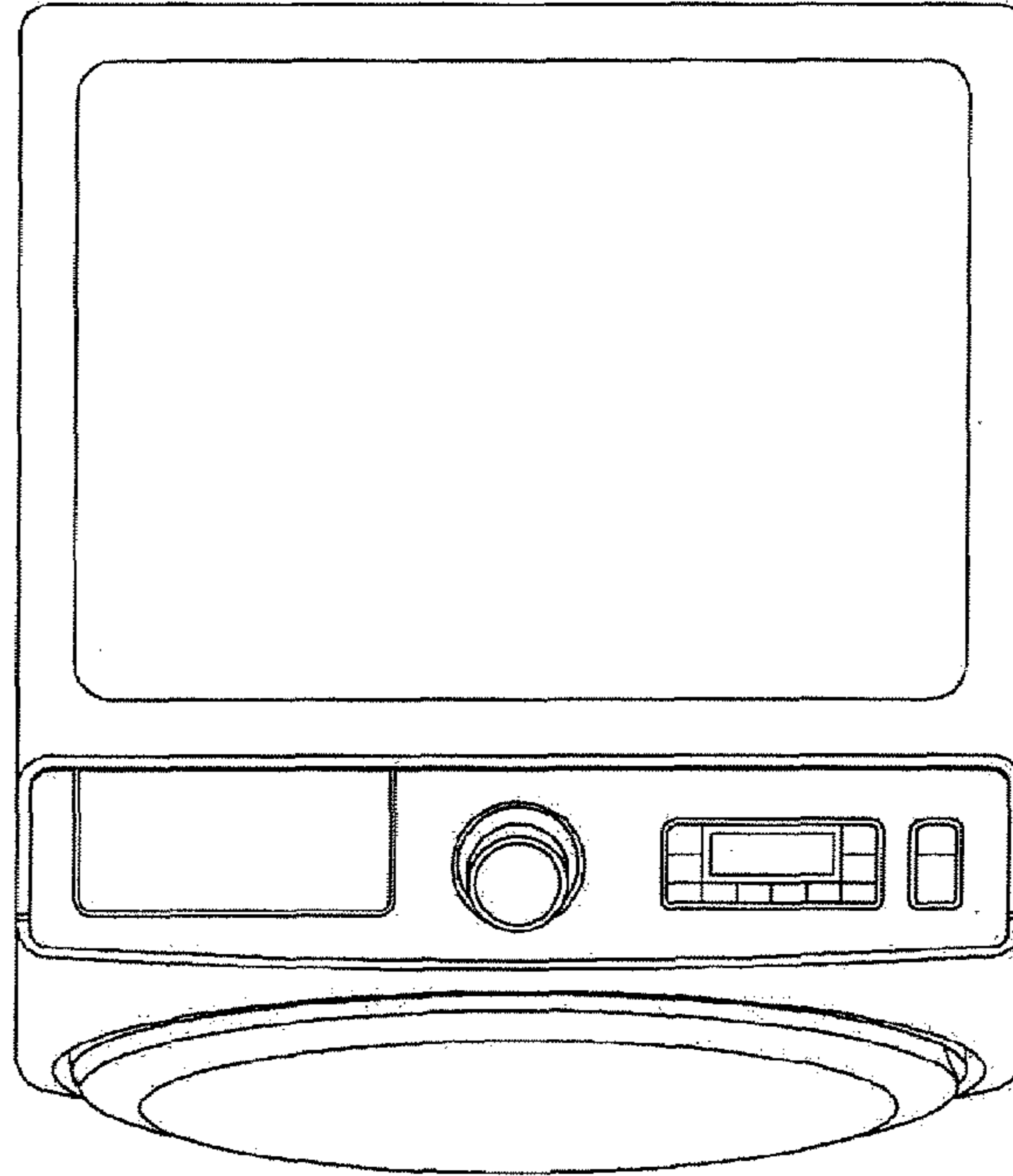

FIG. 7

