

US00D599418S

(12) **United States Design Patent**
Fenster et al.

(10) **Patent No.:** **US D599,418 S**
(45) **Date of Patent:** **** Sep. 1, 2009**

(54) **EXERCISE APPARATUS**

(75) Inventors: **Mrako A. Fenster**, Madison, WI (US);
Mark J. Van Handel, Madison, WI
(US); **Philip N. Stankard**, Madison, WI
(US)

(73) Assignee: **Johnson Health Tech Co., Ltd.**,
Taichung Hsien (TW)

(**) Term: **14 Years**

(21) Appl. No.: **29/310,239**

(22) Filed: **Aug. 5, 2008**

(51) **LOC (9) Cl.** **21-02**

(52) **U.S. Cl.** **D21/675**

(58) **Field of Classification Search** D21/673,
D21/674, 675, 676; 482/94, 99, 101, 2, 103,
482/133, 134, 138

See application file for complete search history.

(56) **References Cited**

U.S. PATENT DOCUMENTS

D262,813	S *	1/1982	Lambert et al.	D21/675
4,603,855	A *	8/1986	Sebelle	482/103
4,775,146	A *	10/1988	Stankovic	482/102
4,856,773	A *	8/1989	Deola	482/102
4,898,381	A *	2/1990	Gordon	482/103
5,725,459	A *	3/1998	Rexach	482/92
6,217,493	B1 *	4/2001	Spletzer	482/103
6,296,594	B1 *	10/2001	Simonson	482/79

6,443,877	B1 *	9/2002	Hoecht et al.	482/103
6,488,612	B2 *	12/2002	Sechrest et al.	482/103
D511,189	S *	11/2005	Panatta	D21/673
6,976,941	B2 *	12/2005	Britt	482/94
7,282,016	B2 *	10/2007	Simonson	482/103

OTHER PUBLICATIONS

Results from google image search for functional trainer Feb. 12, 2009.*

* cited by examiner

Primary Examiner—Philip S Hyder

(57) **CLAIM**

The ornamental design for a exercise apparatus, as shown and described.

DESCRIPTION

FIG. 1 is a perspective view of the exercise apparatus;
FIG. 2 is a left side elevational view of the exercise apparatus;
FIG. 3 is a right side elevational view of the exercise apparatus;
FIG. 4 is a front elevational view of the exercise apparatus;
FIG. 5 is a rear elevational view of the exercise apparatus;
and,
FIG. 6 is a top plan view of the exercise apparatus.

The broken lines in the drawings depict unclaimed environmental subject matter.

1 Claim, 6 Drawing Sheets

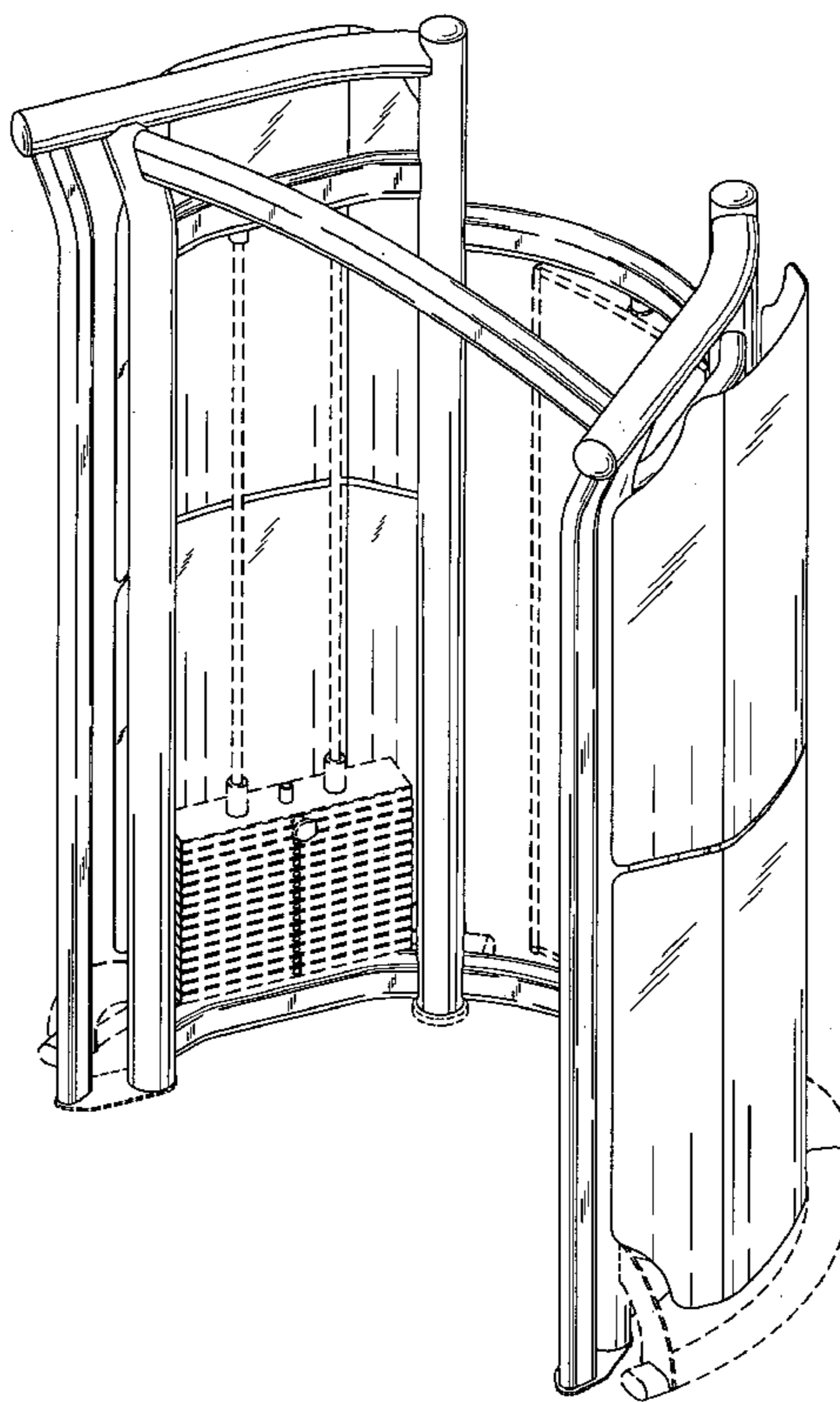

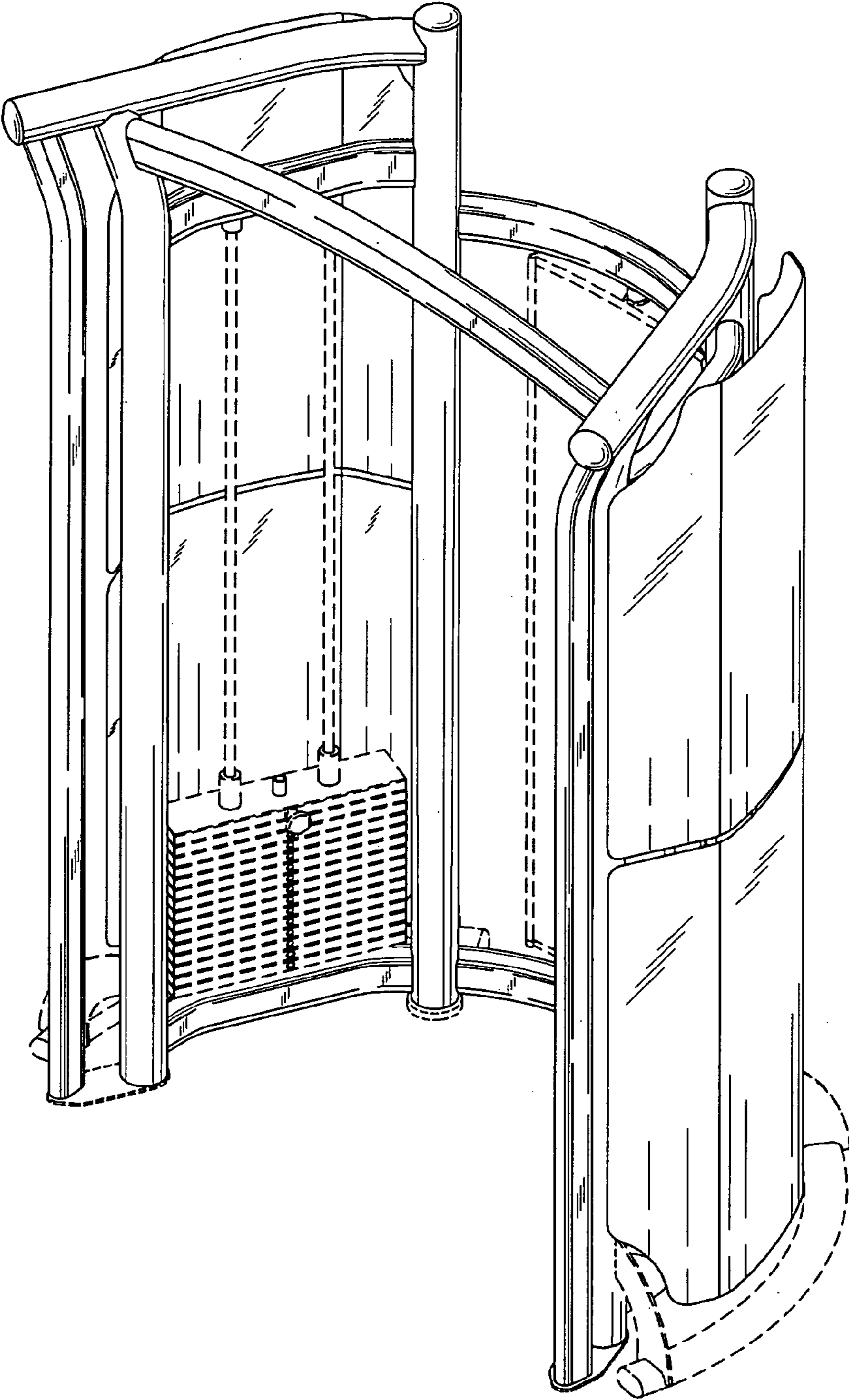

Fig.1

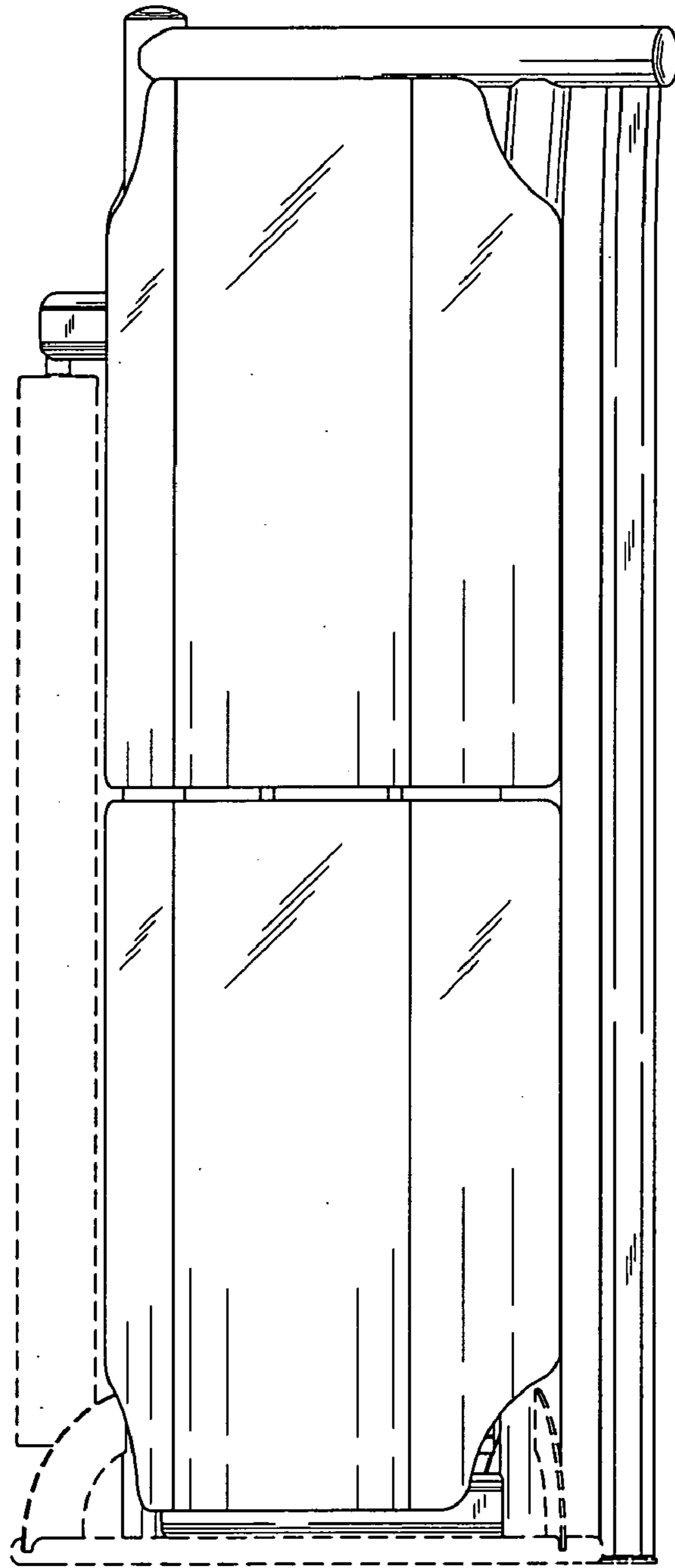

Fig.2

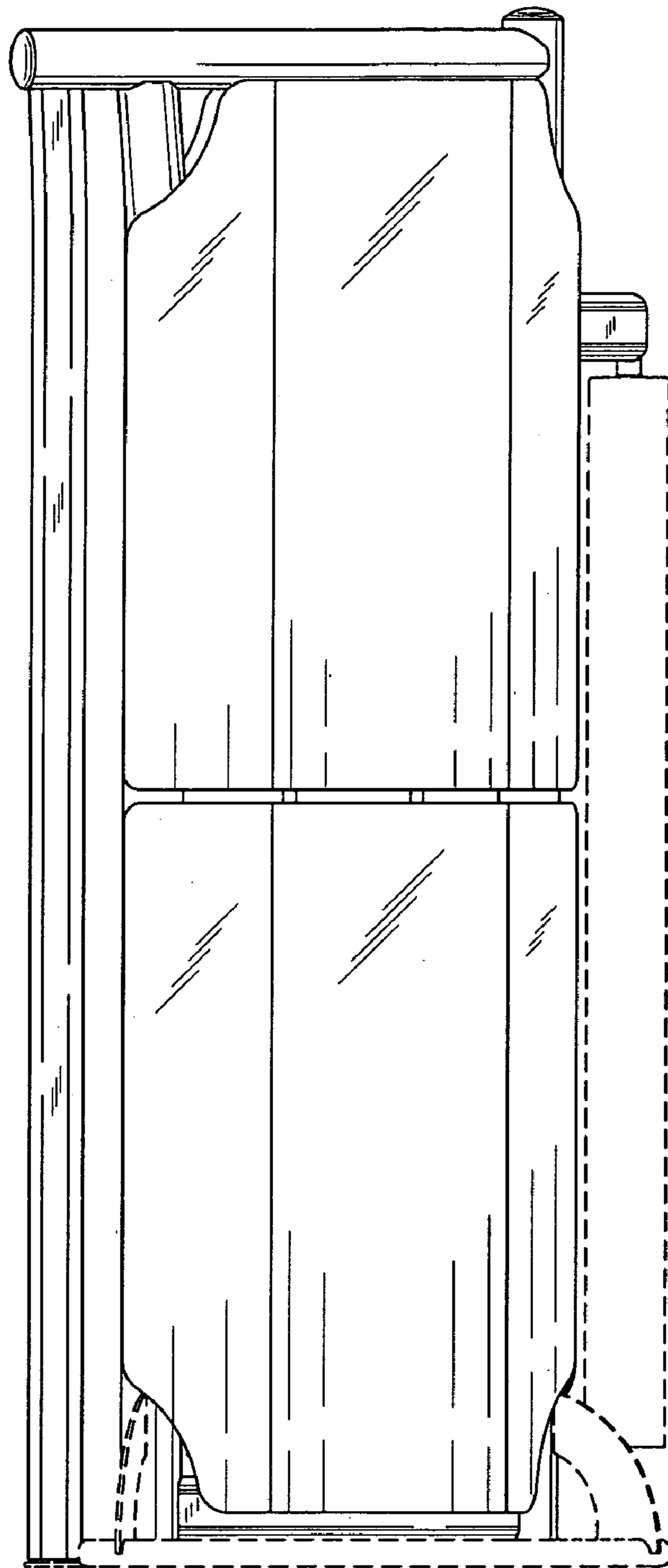

Fig.3

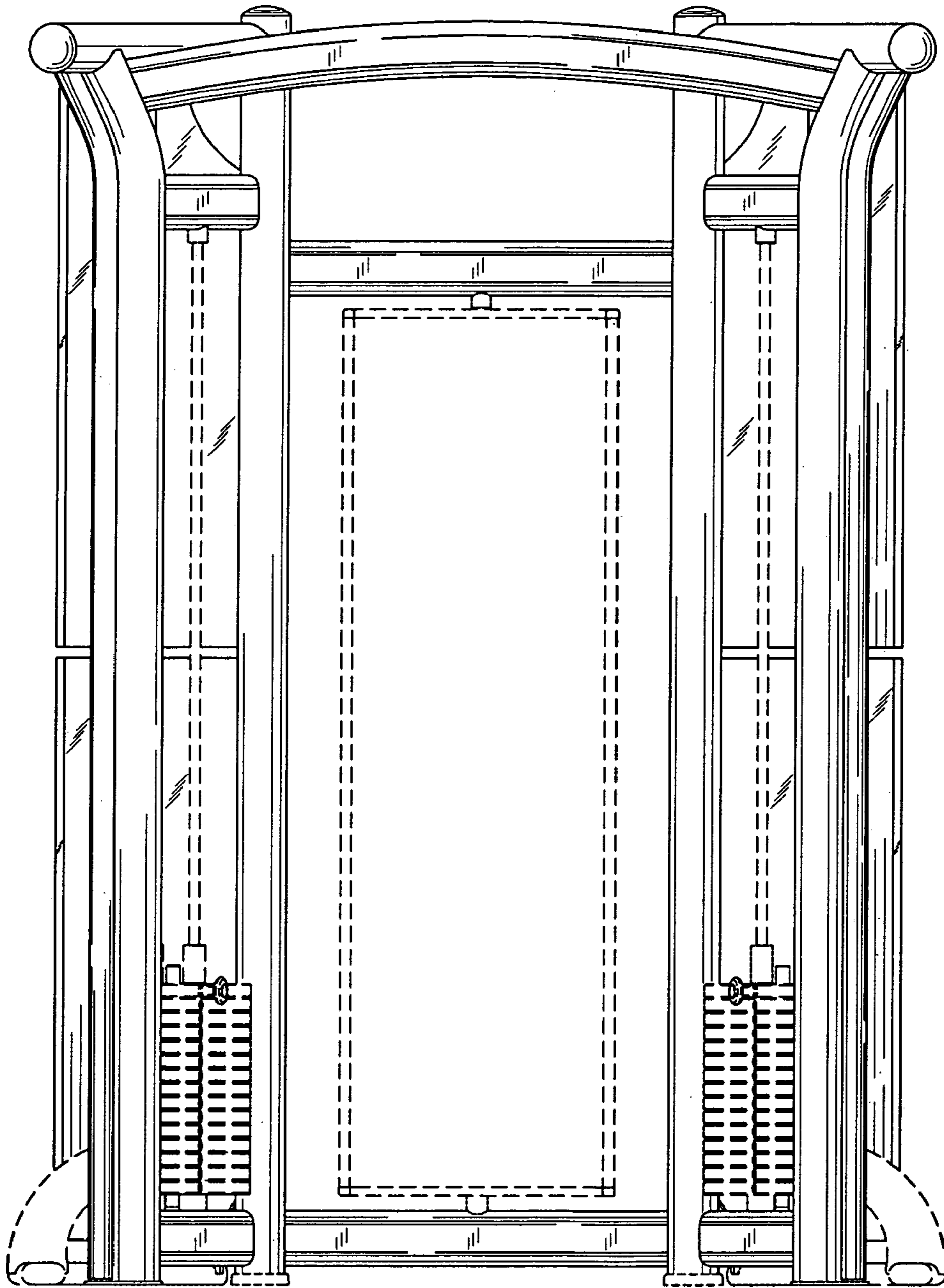

Fig.4

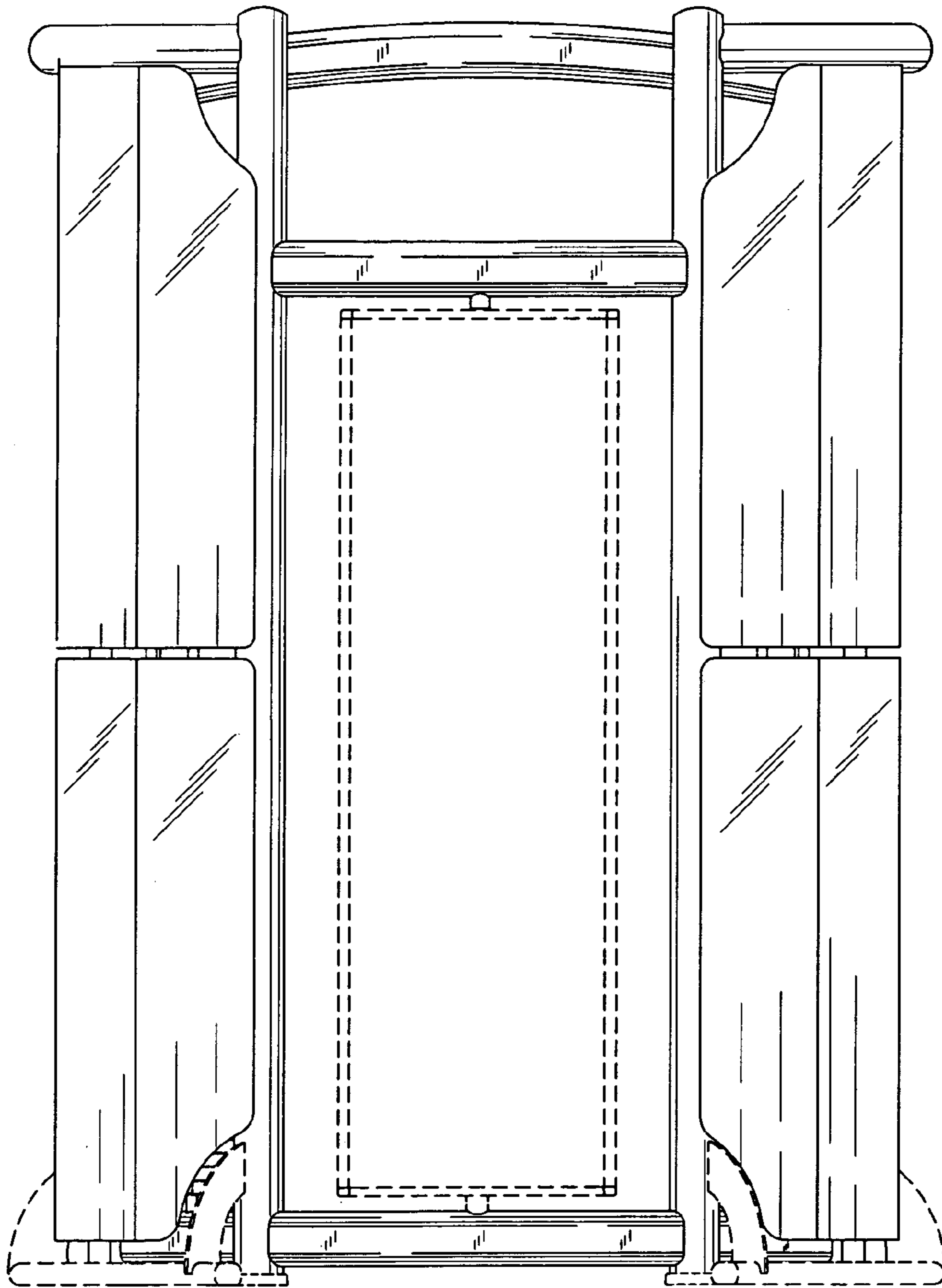

Fig.5

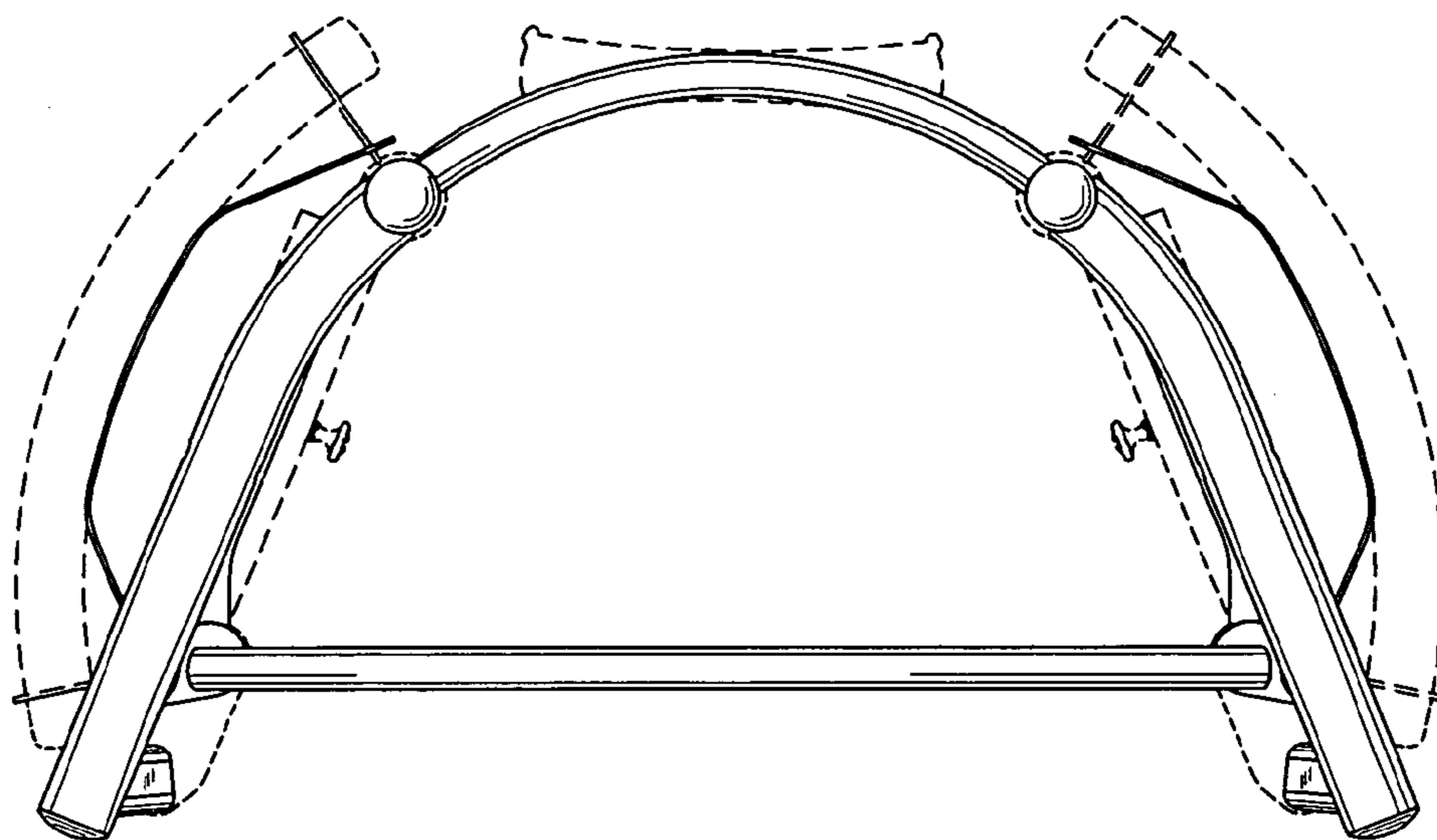

Fig.6