

US00D599339S

(12) **United States Design Patent**
Yau

(10) **Patent No.:** **US D599,339 S**

(45) **Date of Patent:** **** Sep. 1, 2009**

(54) **PERSONAL COMPUTER**

(75) Inventor: **Chi-Jen Yau**, Tao Yuan Shien (TW)

(73) Assignee: **Quanta Computer Inc.**, Kuei Shan Hsiang, Tao Yuan Shien (TW)

(**) Term: **14 Years**

(21) Appl. No.: **29/326,140**

(22) Filed: **Oct. 13, 2008**

(51) **LOC (9) Cl.** **14-02**

(52) **U.S. Cl.** **D14/300**

(58) **Field of Classification Search** D14/300,
D14/125, 126, 240-242, 356-358; 361/680-686,
361/690-696, 752, 679.39; 382/126; D13/184;
381/374

See application file for complete search history.

(56) **References Cited**

U.S. PATENT DOCUMENTS

6,028,950	A *	2/2000	Merjanian	382/126
6,147,859	A *	11/2000	Abboud	361/679.39
D511,343	S *	11/2005	Solomon et al.	D14/356
D518,451	S *	4/2006	Nussberger et al.	D13/184
D520,500	S *	5/2006	Storti et al.	D14/240
D521,001	S *	5/2006	Xiao et al.	D14/356
D529,904	S *	10/2006	Yeo	D14/240
D537,445	S *	2/2007	Bousfield	D14/383

D574,823	S *	8/2008	Wung	D14/357
2004/0032711	A1 *	2/2004	Kaczeus et al.	361/685
2007/0097657	A1 *	5/2007	Huang	361/752

* cited by examiner

Primary Examiner—Freda S Nunn

(74) *Attorney, Agent, or Firm*—Thomas, Kayden, Horstemeyer & Risley

(57) **CLAIM**

The ornamental design for a personal computer, as shown and described.

DESCRIPTION

FIG. 1 is a front, side perspective view of a personal computer showing my new design;

FIG. 2 is a front elevational view thereof;

FIG. 3 is a rear elevational view thereof;

FIG. 4 is a right side elevational view thereof;

FIG. 5 is a left side elevational view thereof;

FIG. 6 is a top plan view thereof;

FIG. 7 is a bottom plan view thereof; and,

FIG. 8 is a front, side perspective view thereof wherein the broken lines shown in the drawing illustrate portions of a display and form no part of the claimed design.

1 Claim, 5 Drawing Sheets

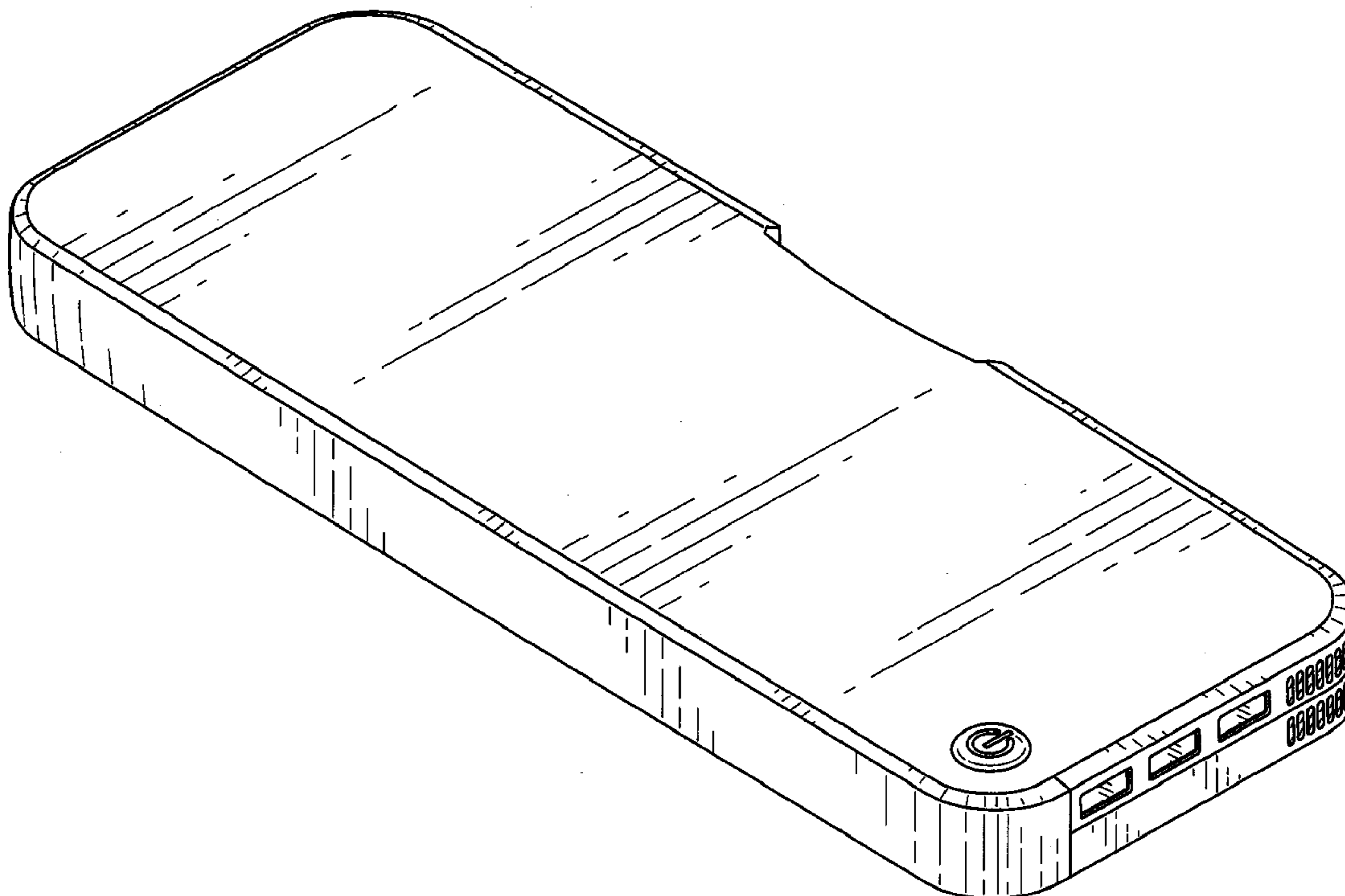

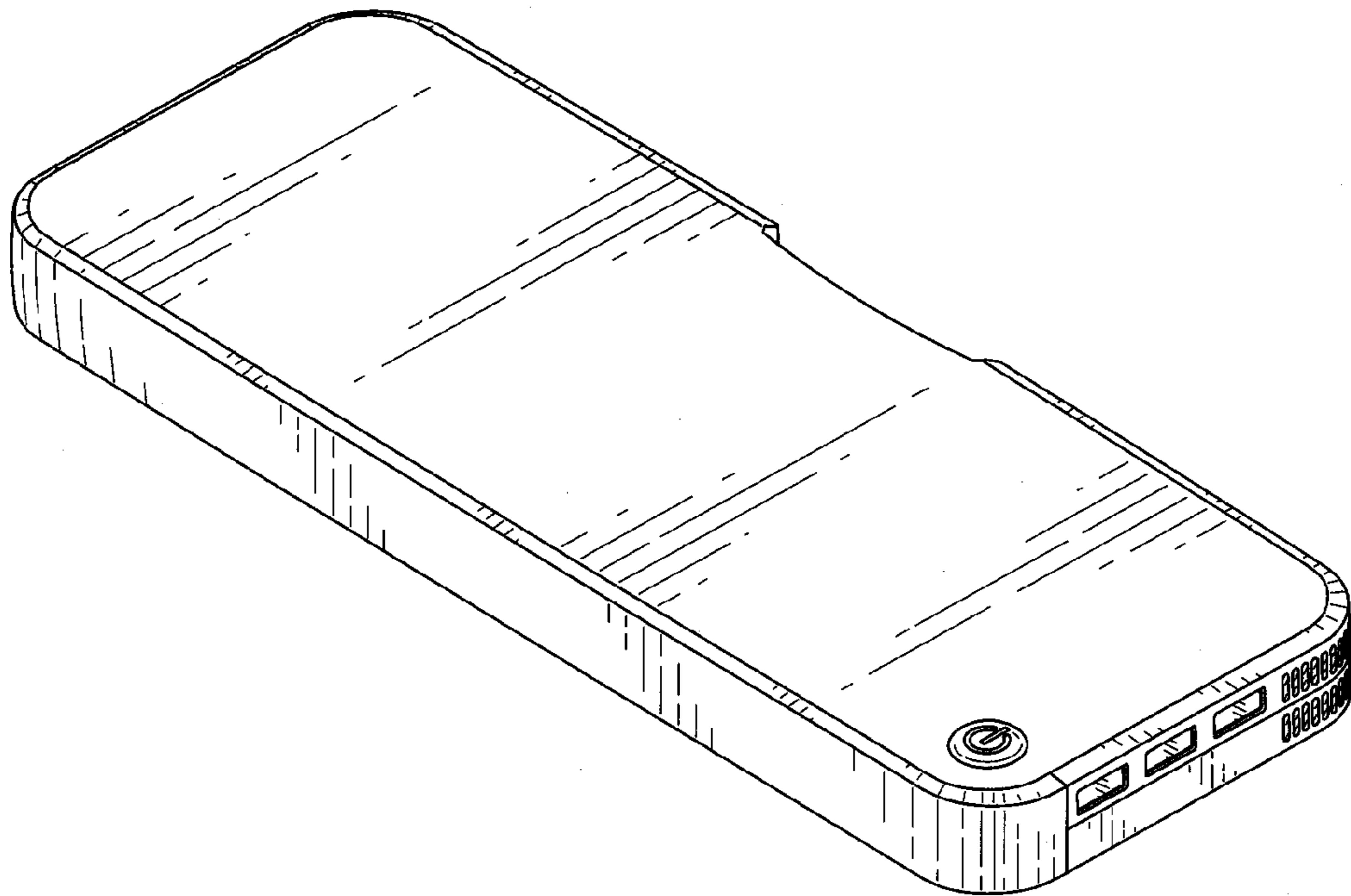

FIG. 1

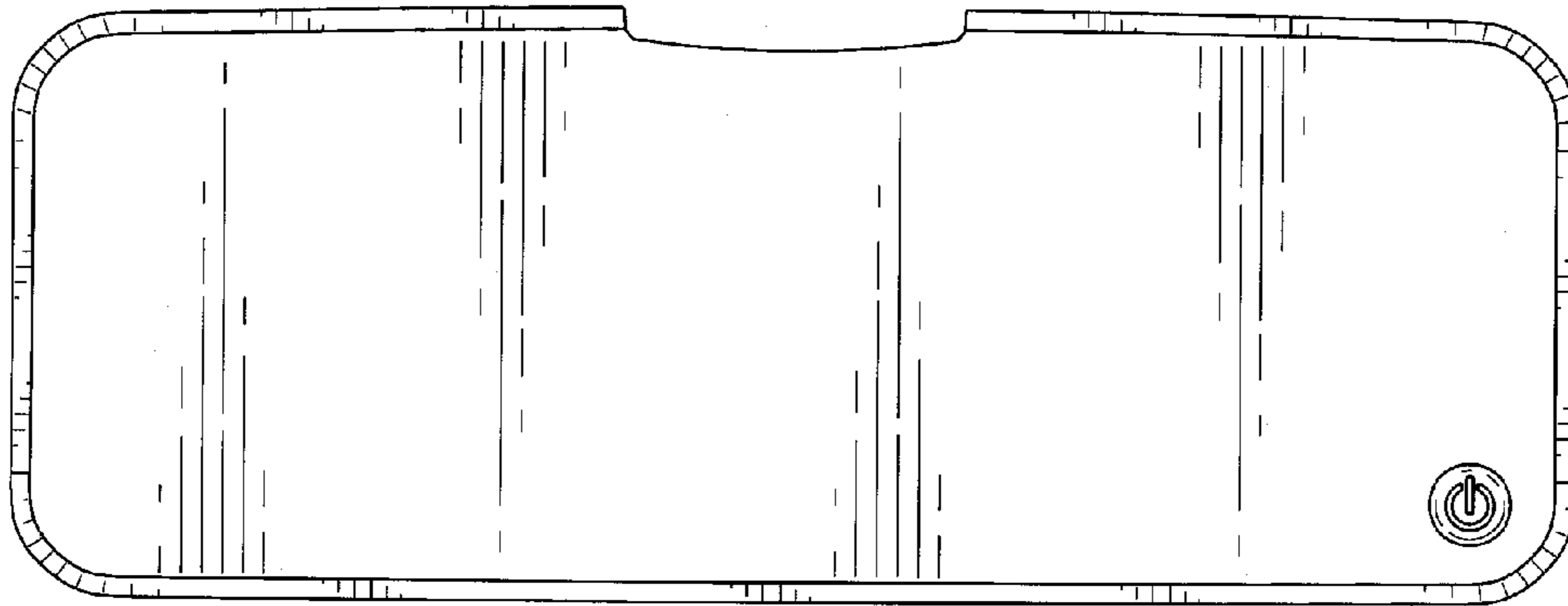

FIG. 2

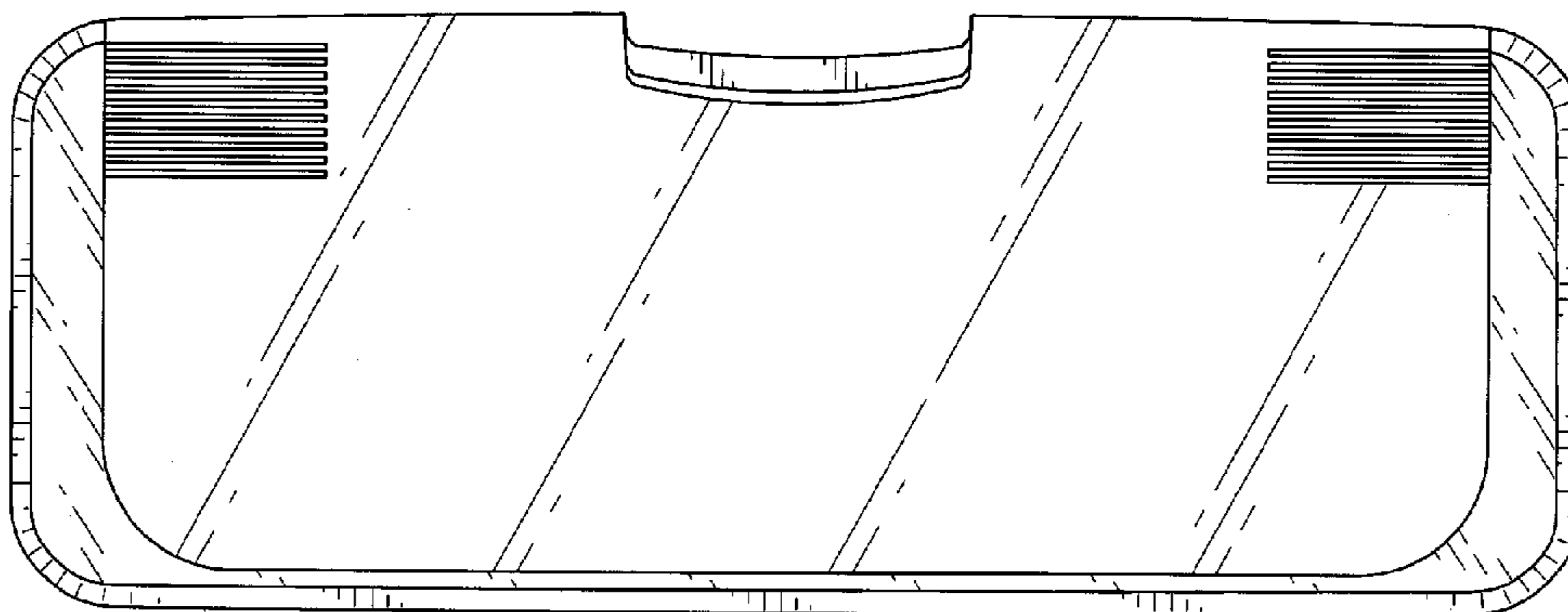

FIG. 3

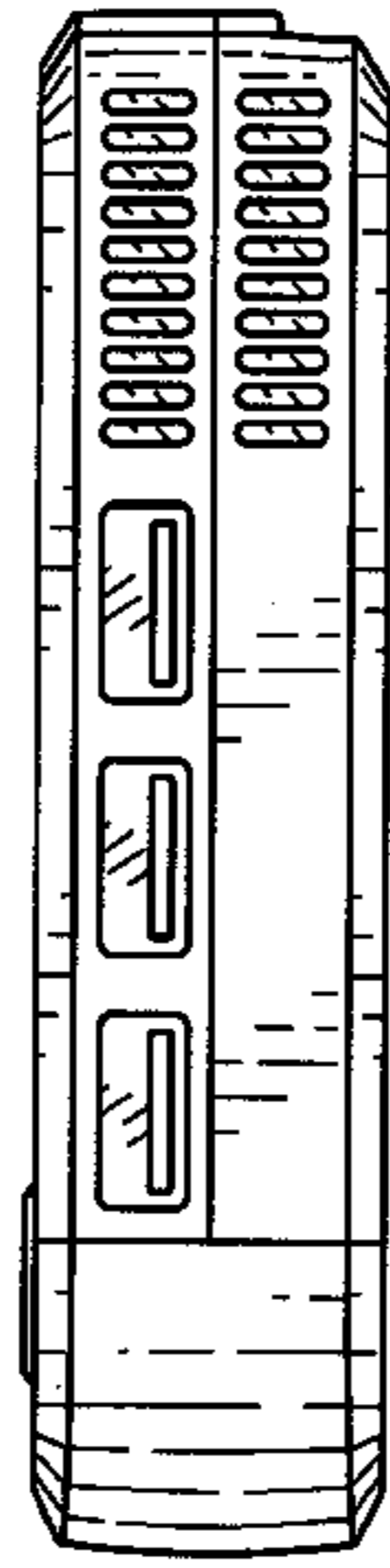

FIG. 4

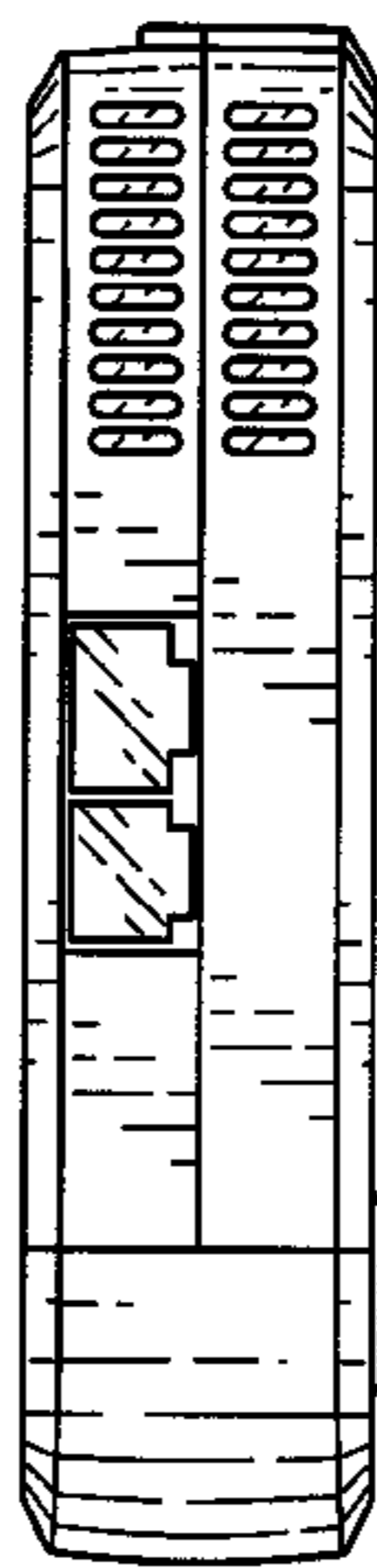

FIG. 5



FIG. 6

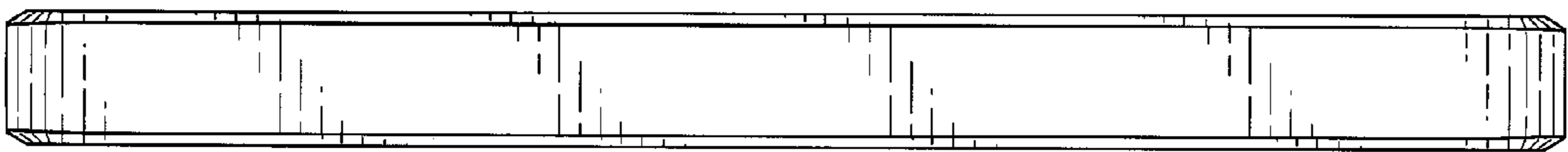

FIG. 7

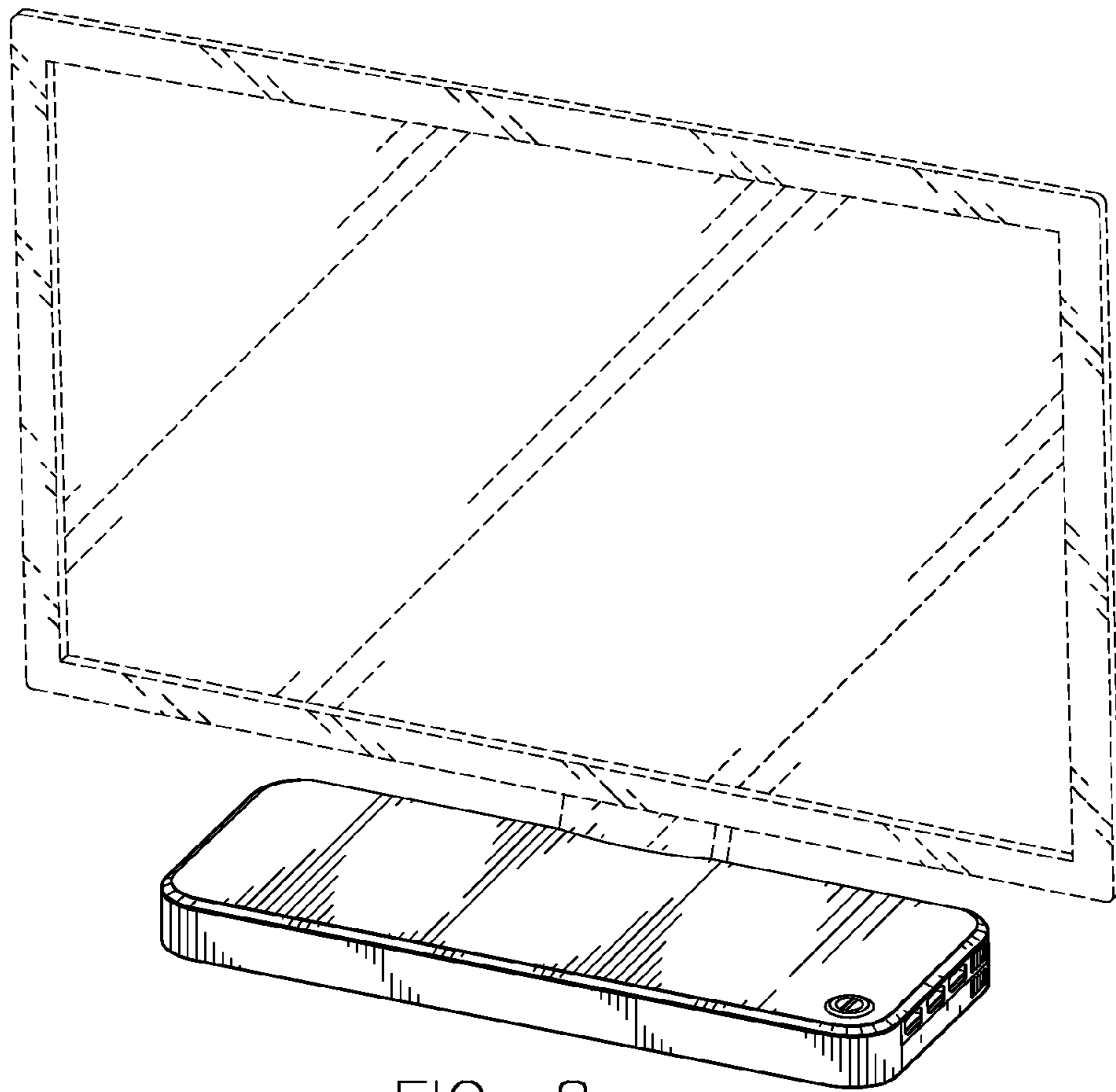

FIG. 8