



US00D599320S

(12) **United States Design Patent**
Sterzick et al.

(10) **Patent No.:** **US D599,320 S**
(45) **Date of Patent:** **** Sep. 1, 2009**

(54) **CELLULAR PHONE**

(75) Inventors: **Mark Sterzick**, Rancho Dominguez, CA (US); **Susanne Chambers**, Rancho Dominguez, CA (US)

(73) Assignee: **Samsung Electronics Co., Ltd.**, Suwon-Si (KR)

(**) Term: **14 Years**

(21) Appl. No.: **29/326,181**

(22) Filed: **Oct. 14, 2008**

(51) **LOC (9) Cl.** **14-03**

(52) **U.S. Cl.** **D14/138 AD**

(58) **Field of Classification Search** D14/138 R, D14/138 AD, 138 AC, 138 C, 138 G, 191, D14/203.1–203.8, 496, 138 AA, 138 AB, D14/247–248, 137, 147, 218, 341–347; D10/65, D10/78, 104; D13/168; D18/7; 455/566, 455/575.1, 575.3

See application file for complete search history.

(56) **References Cited**

U.S. PATENT DOCUMENTS

D495,695 S *	9/2004	Yugaya	D14/346
D508,473 S *	8/2005	Lee et al.	D14/138 AD
D526,297 S *	8/2006	Lee et al.	D14/138 AD
D529,474 S *	10/2006	Park et al.	D14/138 AD
D529,475 S *	10/2006	Lee et al.	D14/138 AD
D548,714 S *	8/2007	Kim et al.	D14/138 AD
D548,715 S *	8/2007	Lee et al.	D14/138 AD
D552,581 S *	10/2007	Kim et al.	D14/138 AD
D553,599 S *	10/2007	Lee et al.	D14/138 AC
D557,245 S *	12/2007	Kim et al.	D14/138 AD
D557,672 S *	12/2007	Bae	D14/138 AD
D558,715 S *	1/2008	Lee	D14/138 AD
D561,512 S *	2/2008	Park et al.	D14/138 AD
D572,227 S *	7/2008	Yoon et al.	D14/138 G
D575,759 S *	8/2008	Park et al.	D14/138 AD
D576,596 S *	9/2008	Moon et al.	D14/138 AD
D579,899 S *	11/2008	Park et al.	D14/138 AD

D581,386 S *	11/2008	Oh et al.	D14/138 AD
D583,789 S *	12/2008	Chambers	D14/138 AD
D584,708 S *	1/2009	Wu et al.	D14/138 AD
D590,803 S *	4/2009	Rihu	D14/138 AD
D591,709 S *	5/2009	Rihu	D14/138 AD
2005/0124381 A1 *	6/2005	Kim et al.	455/556.1
2007/0021160 A1 *	1/2007	Li	455/575.4
2008/0225109 A1 *	9/2008	Lee	348/14.02

OTHER PUBLICATIONS

Huawei U7310, announced 2nd quarter 2008, [online], [retrieved on Feb. 20, 2009]. Retrieved from Internet ,<URL: <http://www.gsmarena.com>>.*

LG KG290, announced Sep. 2007, [online], [retrieved on Dec. 13, 2007]. Retrieved from Internet ,<URL: <http://www.gsmarena.com>>.*

US D562,296, 02/2008, Yoon (withdrawn)*

* cited by examiner

Primary Examiner—Jeffrey D Asch

Assistant Examiner—Bridget L Eland

(74) *Attorney, Agent, or Firm*—Staas & Halsey LLP

(57) **CLAIM**

The ornamental design for a cellular phone, as shown and described.

DESCRIPTION

FIG. 1 is a perspective view of a cellular phone showing our new design;

FIG. 2 is a front elevational view thereof;

FIG. 3 is a rear elevational view thereof;

FIG. 4 is a left side elevational view thereof;

FIG. 5 is a right side elevational view thereof;

FIG. 6 is a top plan view thereof;

FIG. 7 is a bottom plan view thereof; and,

FIG. 8 is a perspective slid up open view of the cellular phone showing our new design in a state in which the cellular phone is open when used.

1 Claim, 6 Drawing Sheets

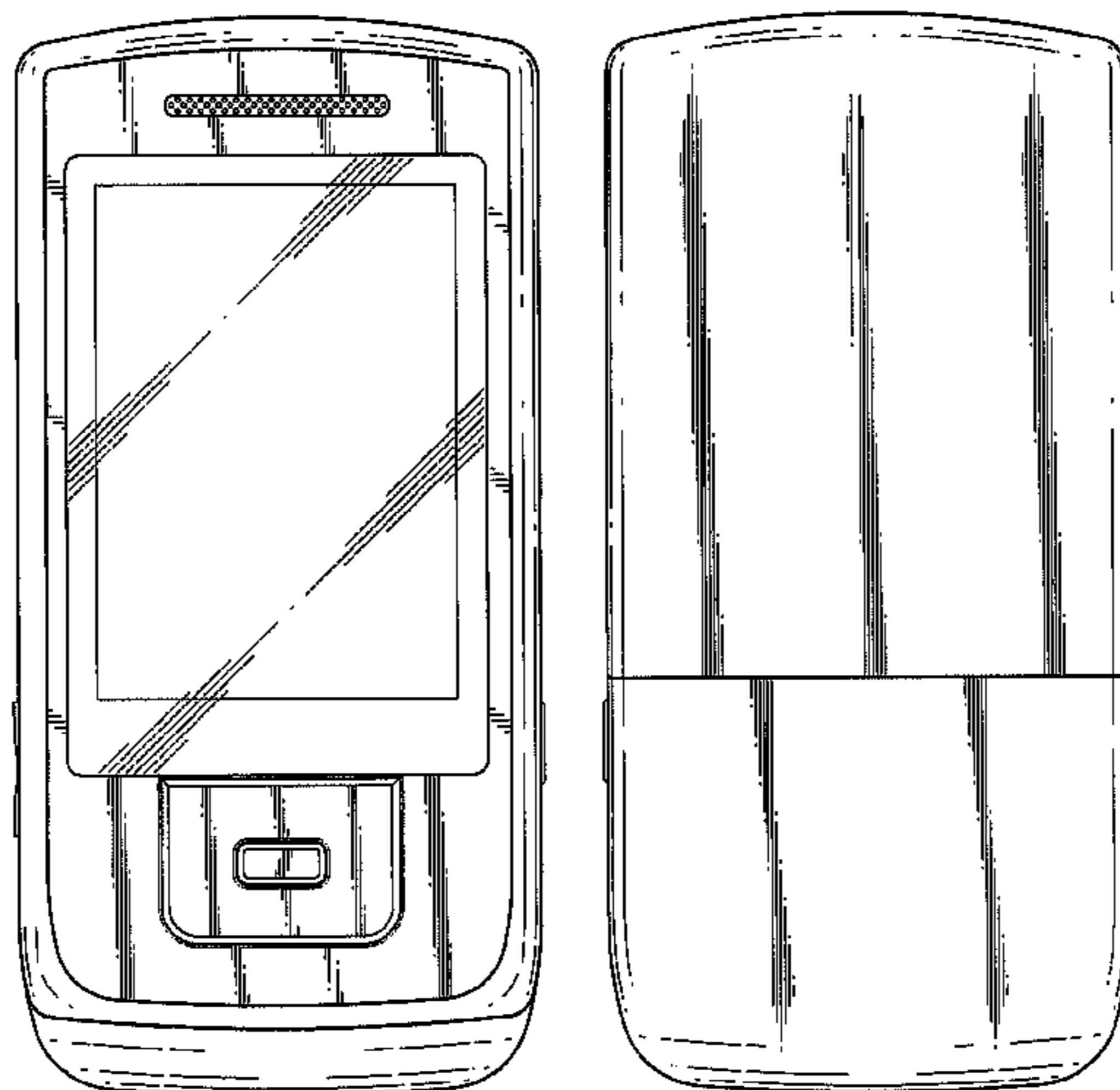

FIG. 1

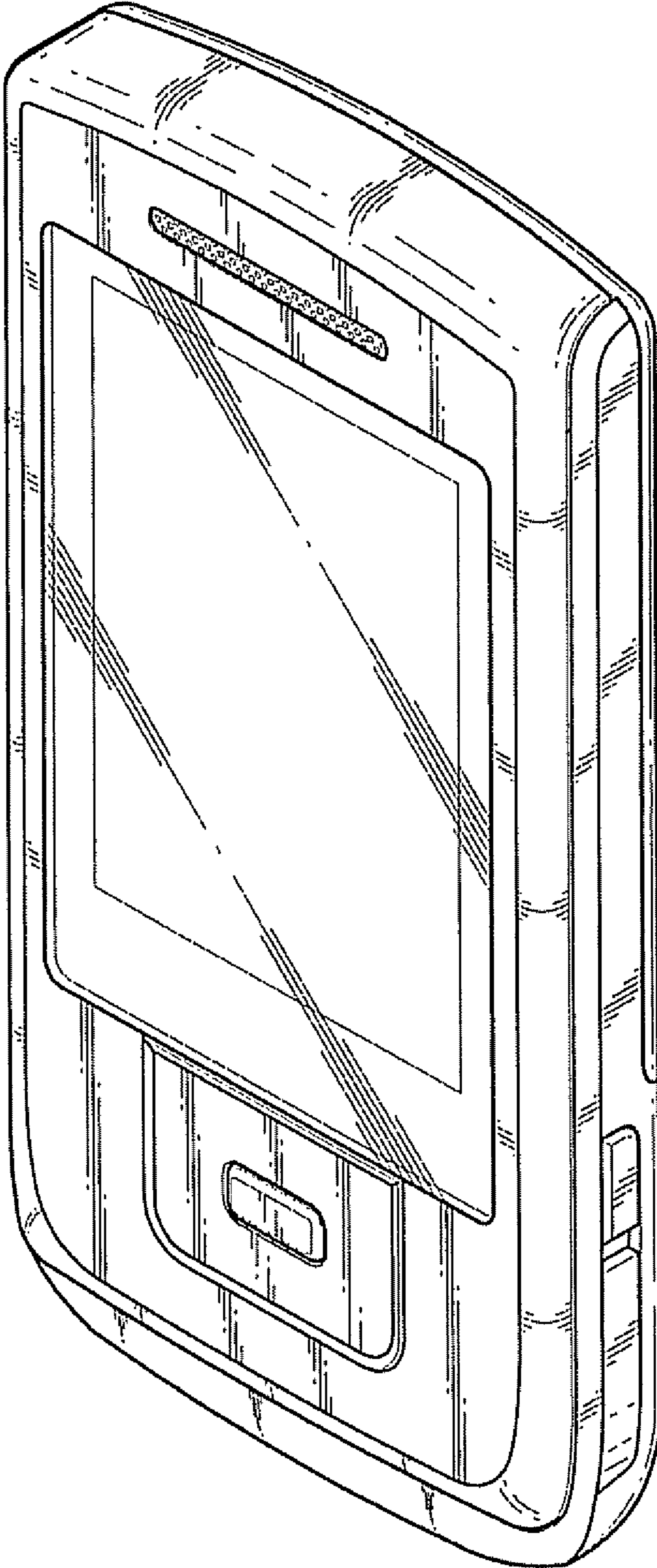

FIG. 2

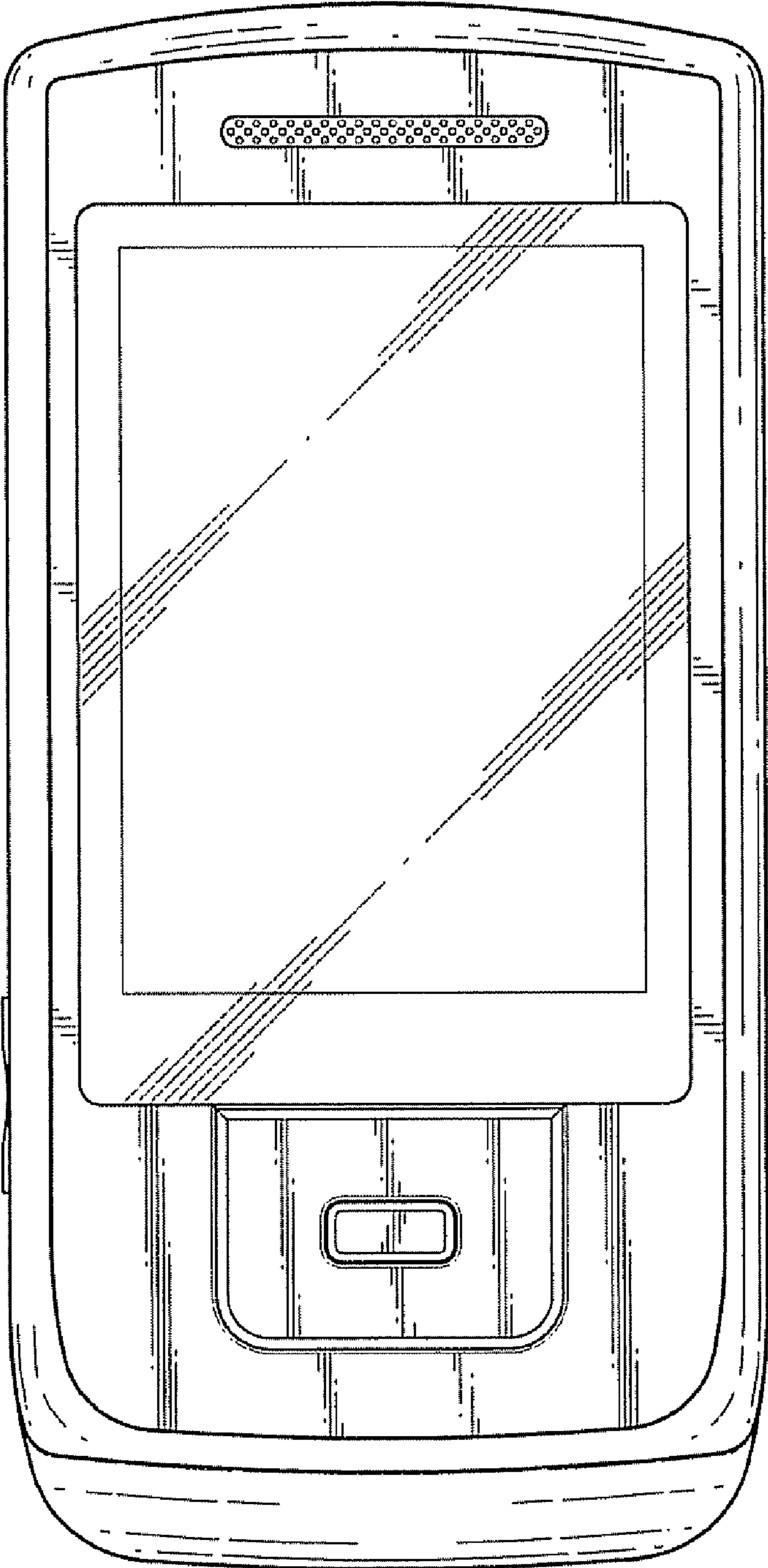

FIG. 3

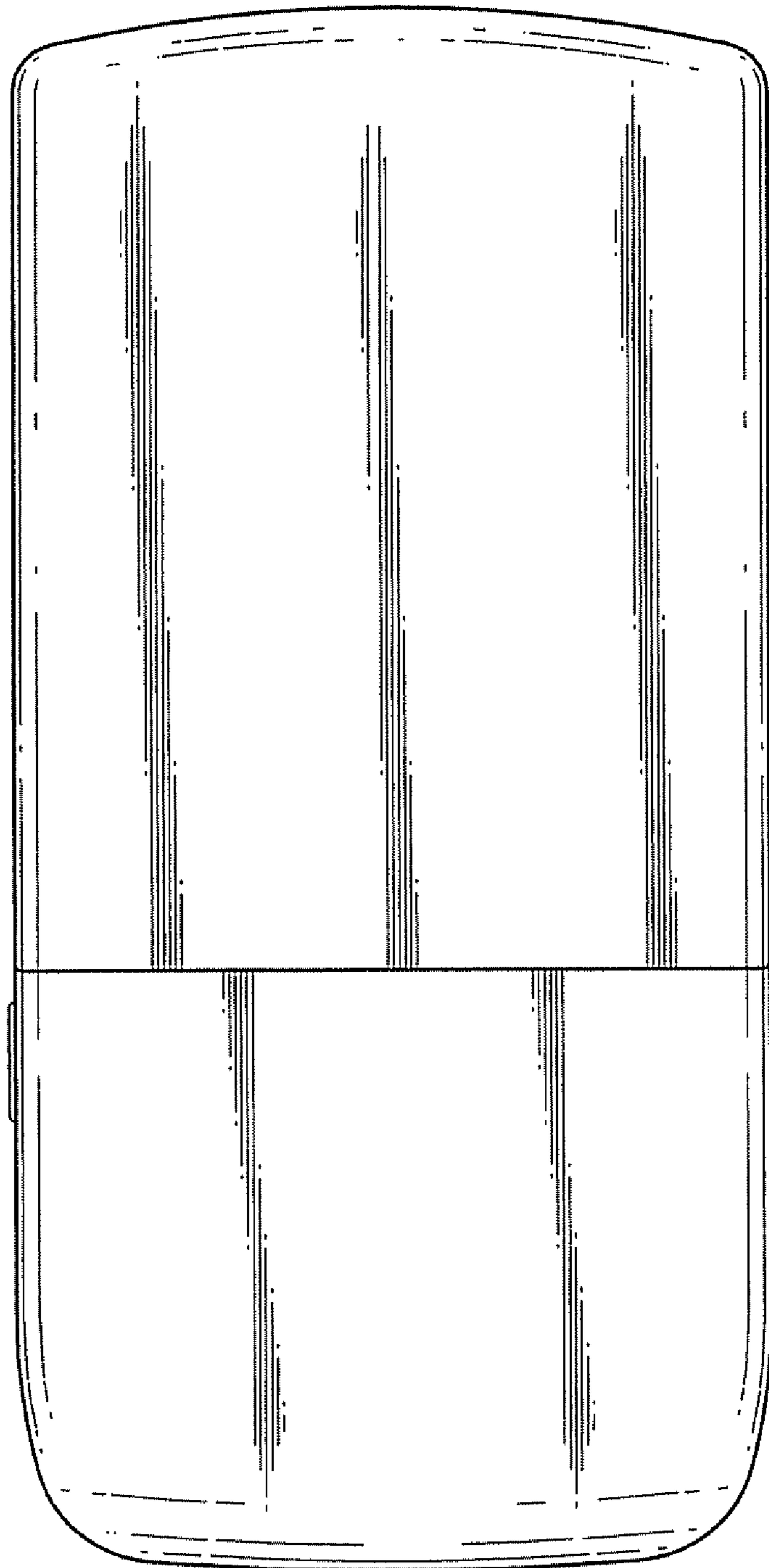

FIG. 4

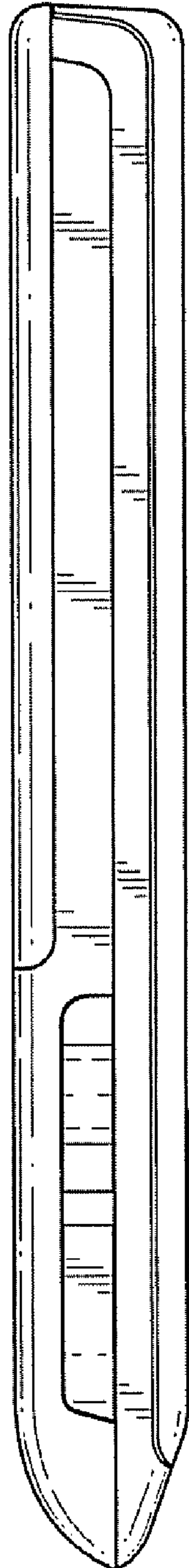

FIG. 5

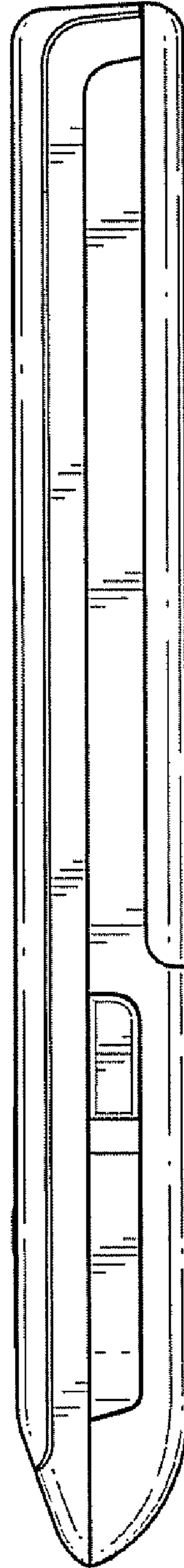

FIG. 6

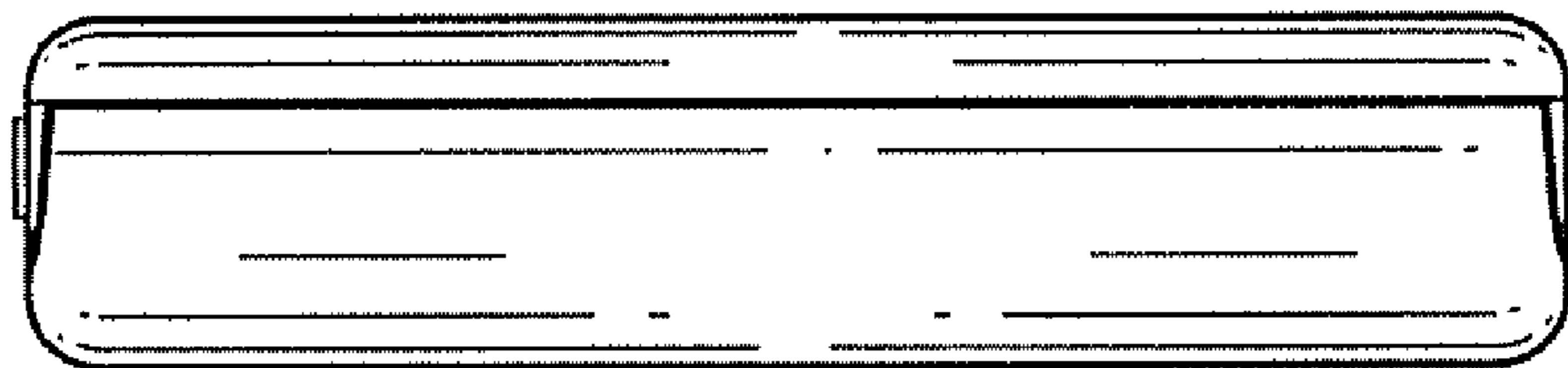

FIG. 7

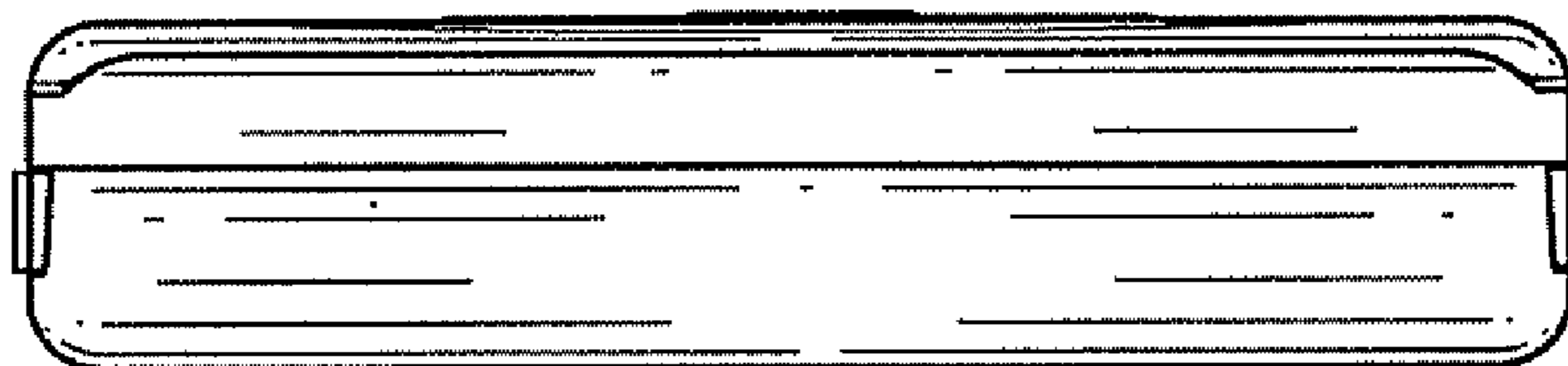

FIG. 8

