



US00D599249S

(12) **United States Design Patent**  
**Blasi**

(10) **Patent No.:** **US D599,249 S**  
(45) **Date of Patent:** **\*\* Sep. 1, 2009**

(54) **VEHICLE, TOY AND/OR REPLICA THEREOF**

D583,711 S \* 12/2008 Elmitt ..... D12/92

(75) Inventor: **Juliane Blasi**, Munich (DE)

FOREIGN PATENT DOCUMENTS

(73) Assignee: **Bayerische Motoren Werke Aktiengesellschaft**, Munich (DE)

EM 000485305-0001 6/2006

\* cited by examiner

(\*\*) Term: **14 Years**

*Primary Examiner*—Melody N Brown

(74) *Attorney, Agent, or Firm*—Crowell & Moring LLP

(21) Appl. No.: **29/309,983**

(57) **CLAIM**

(22) Filed: **Nov. 26, 2008**

The ornamental design for a vehicle, toy and/or replica thereof, as shown and described.

(30) **Foreign Application Priority Data**

May 30, 2008 (DE) ..... 402008002665

**DESCRIPTION**

(51) **LOC (9) Cl.** ..... **12-08**

FIG. 1 is a left, front perspective view of a vehicle, toy and/or replica thereof according to my novel design;

(52) **U.S. Cl.** ..... **D12/92**

FIG. 2 is a left, rear perspective view thereof;

(58) **Field of Classification Search** ..... D12/86,  
D12/90-92; 296/181.1, 181.5

FIG. 3 is a left side view thereof;

See application file for complete search history.

FIG. 4 is a right side view thereof;

(56) **References Cited**

FIG. 5 is a front view thereof;

U.S. PATENT DOCUMENTS

FIG. 6 is a rear view thereof; and,

D480,021 S 9/2003 Warming

FIG. 7 is a top view thereof.

D538,712 S 3/2007 Sycha

The broken lines are for illustrative purposes only and form no part of the claimed design.

D553,052 S 10/2007 Hettler

D564,945 S \* 3/2008 Chung et al. .... D12/92

**1 Claim, 6 Drawing Sheets**

D575,679 S \* 8/2008 Habib ..... D12/92

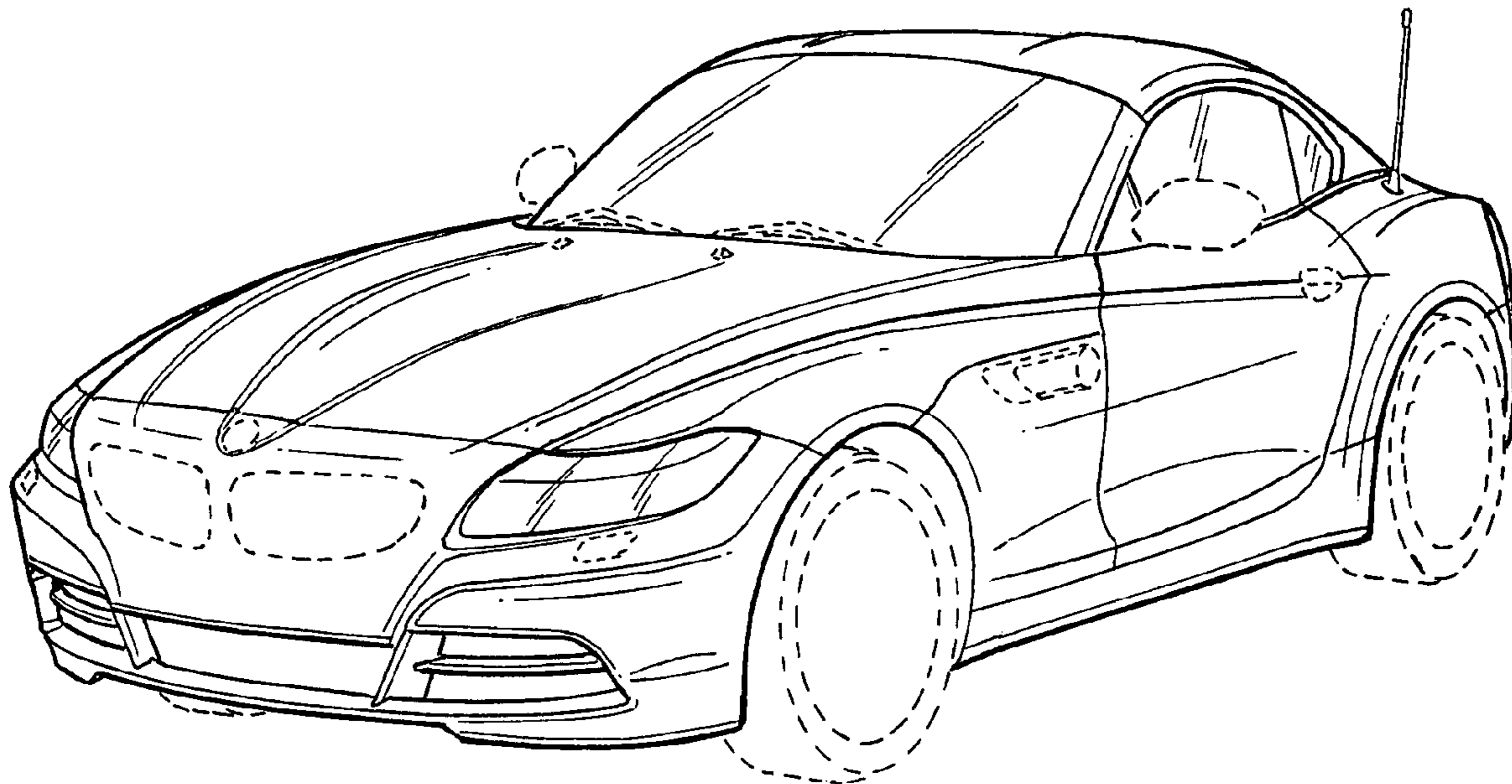

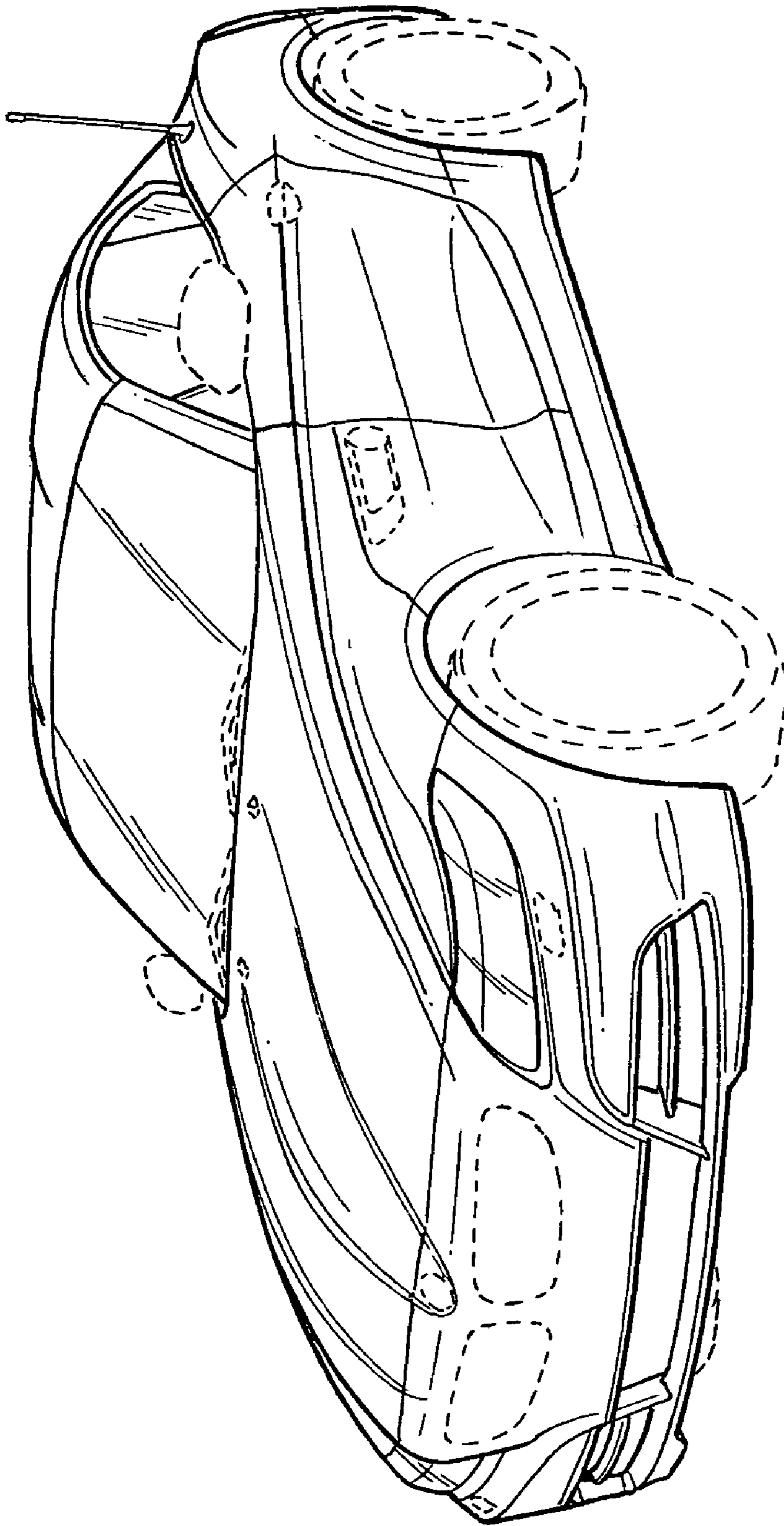

FIG. 1

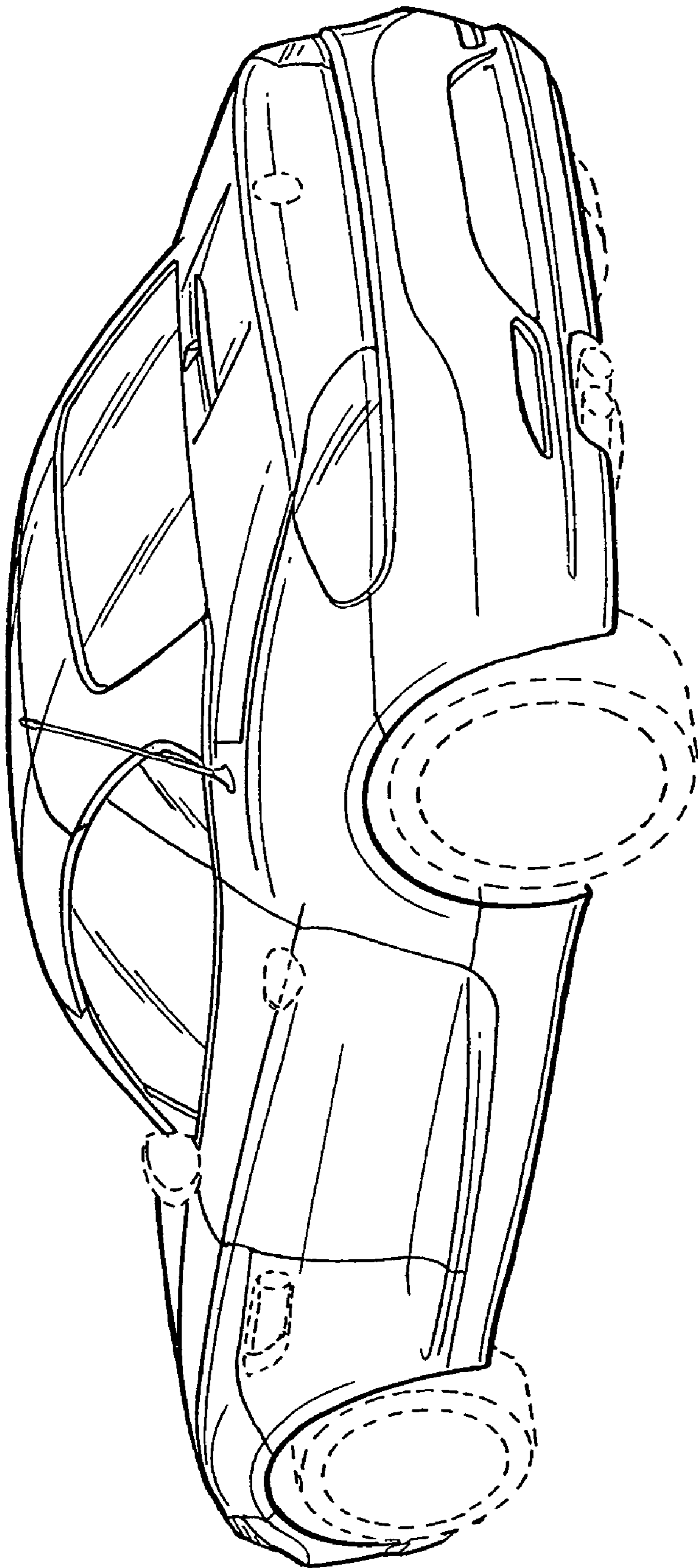

FIG. 2

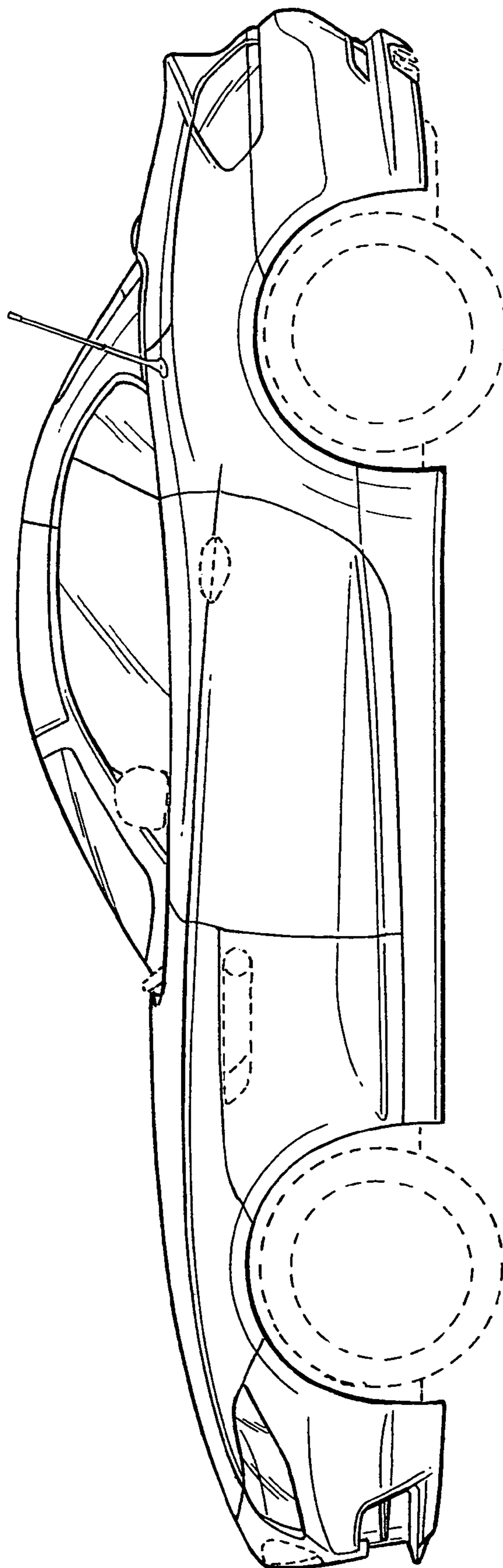

FIG. 3



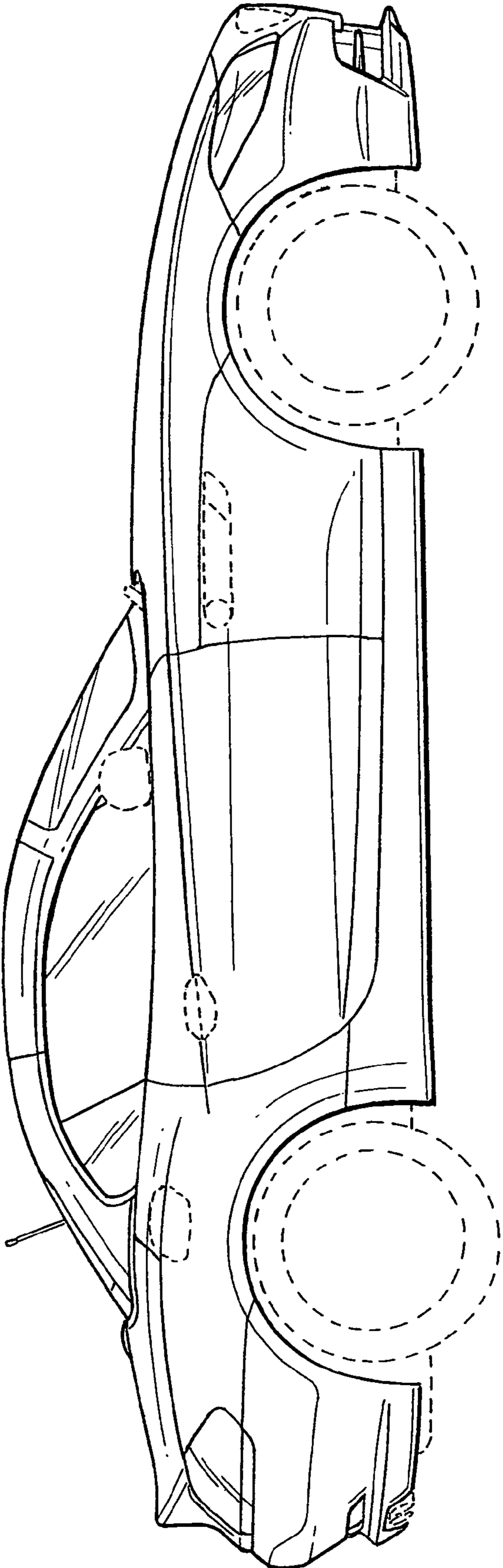

FIG. 4

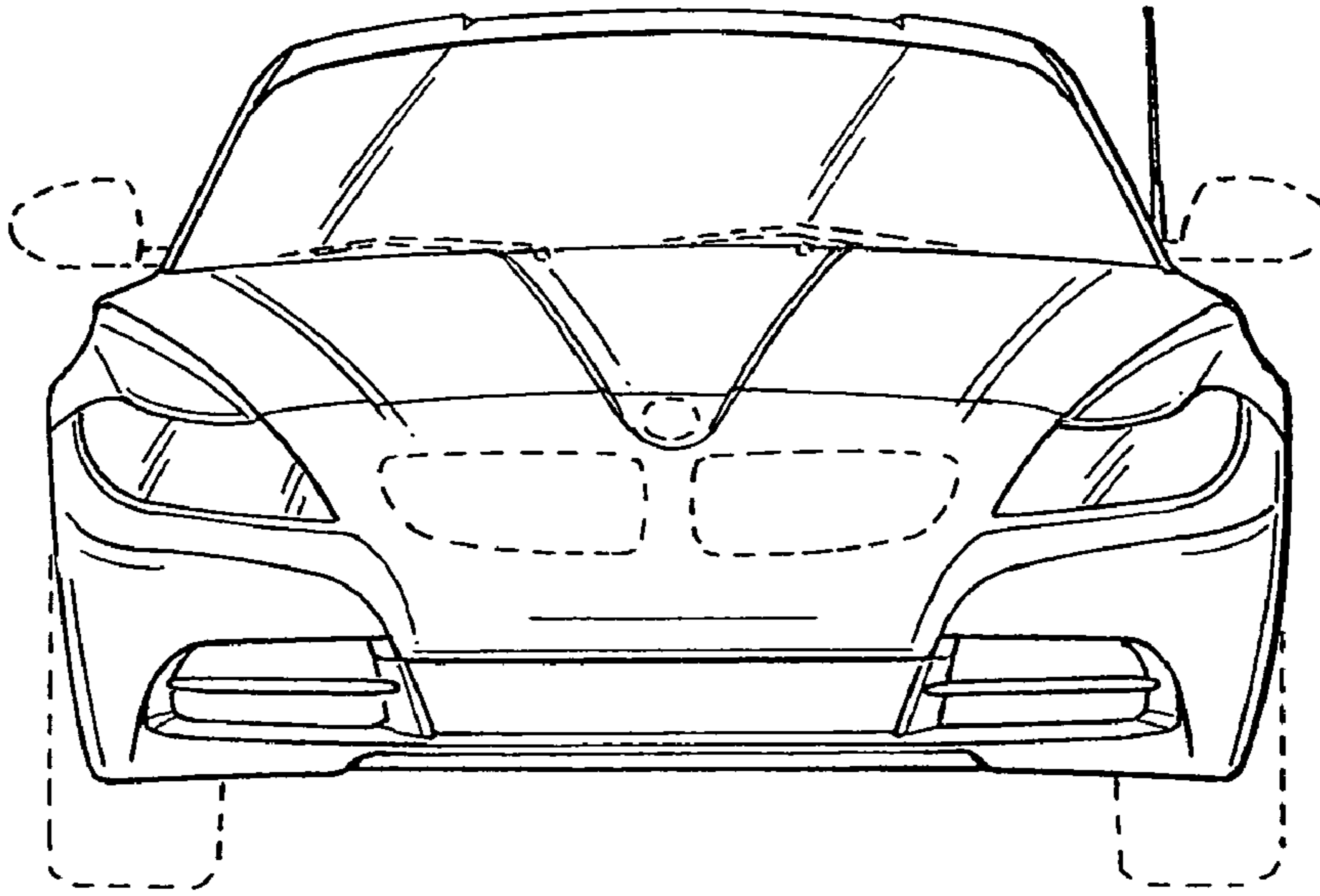

FIG. 5

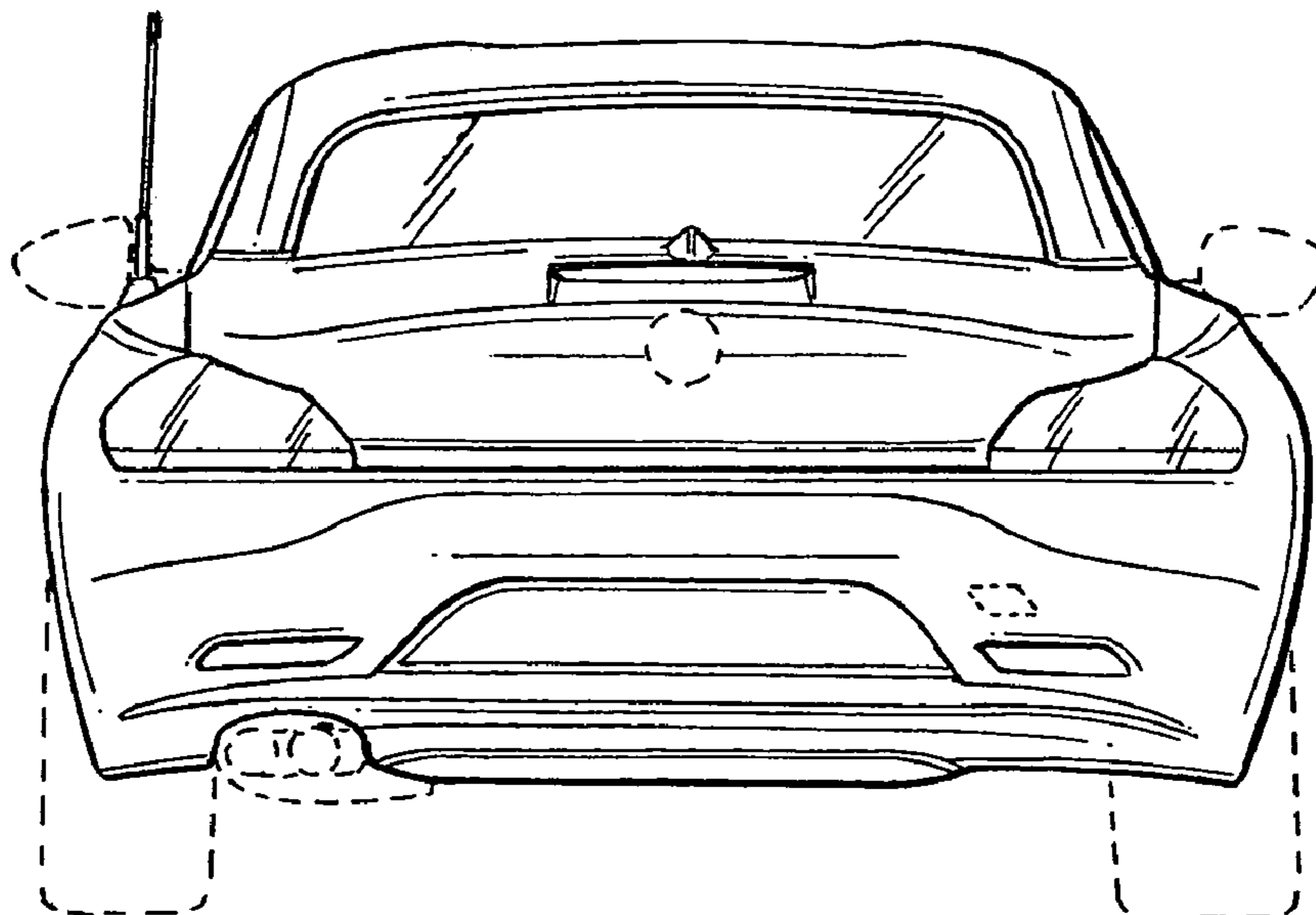

FIG. 6

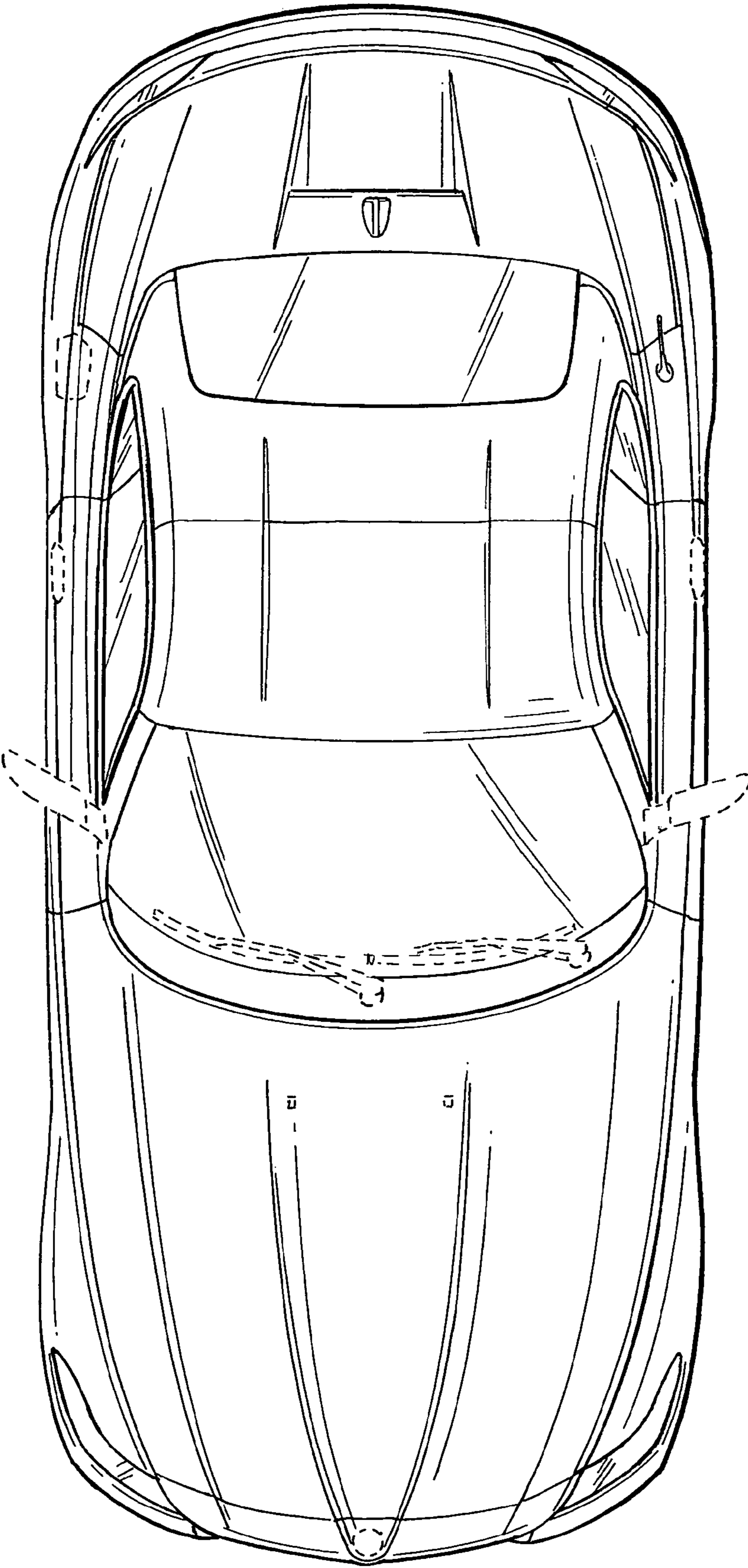

FIG. 7