



US00D599155S

(12) **United States Design Patent**
Wynalda, Jr. et al.

(10) **Patent No.:** **US D599,155 S**
(45) **Date of Patent:** **** Sep. 1, 2009**

(54) **MERCHANDISE STORAGE CONTAINER**

(76) Inventors: **Robert M. Wynalda, Jr.**, P.O. Box 370,
Belmont, MI (US) 49306; **Robert G.
Rajter, Jr.**, P.O. Box 370, Belmont, MI
(US) 49306

(**) Term: **14 Years**

(21) Appl. No.: **29/323,759**

(22) Filed: **Aug. 29, 2008**

(51) **LOC (9) Cl.** **06-02**

(52) **U.S. Cl.** **D6/627**

(58) **Field of Classification Search** D6/407,
D6/626-635; D9/415, 418, 420, 422, 423,
D9/424, 425, 426, 428, 432, 433; D19/26,
D19/27; 206/307, 307.1, 308.1, 309, 311,
206/312, 313, 310, 751; 211/40, 41.1, 41.12;
D3/273, 294, 295, 299-301, 303, 271.2;
D21/655

See application file for complete search history.

(56) **References Cited**

U.S. PATENT DOCUMENTS

5,085,318 A * 2/1992 Leverick 206/308.1
D360,360 S * 7/1995 Kiolbasa D9/433
5,460,265 A * 10/1995 Kiolbasa 206/308.1
D387,976 S * 12/1997 Mori D6/634
D406,002 S * 2/1999 Price D6/634

D417,974 S * 12/1999 Mori D6/407
D428,730 S * 8/2000 Farnstrom D6/407
D430,445 S * 9/2000 Pozzoli D6/634
D433,808 S * 11/2000 Moorhouse, Sr. D3/303
D443,435 S * 6/2001 Farnstrom D6/407
D451,384 S * 12/2001 Faulstich D9/422

* cited by examiner

Primary Examiner—Charles A Rademaker

Assistant Examiner—Charles D Hanson

(74) *Attorney, Agent, or Firm*—Zollinger & Burleson Ltd

(57) **CLAIM**

The ornamental design for the merchandise storage container,
as shown and described.

DESCRIPTION

FIG. 1 is a perspective view of a merchandise storage con-
tainer showing our new design;

FIG. 2 is a front view thereof;

FIG. 3 is a rear view thereof;

FIG. 4 is a bottom view thereof;

FIG. 5 is a top view thereof;

FIG. 6 is a left side view thereof; and,

FIG. 7 is a right side view thereof.

The broken line showing is included for the purpose of illus-
trating environment and forms no part of the claimed design.

1 Claim, 5 Drawing Sheets

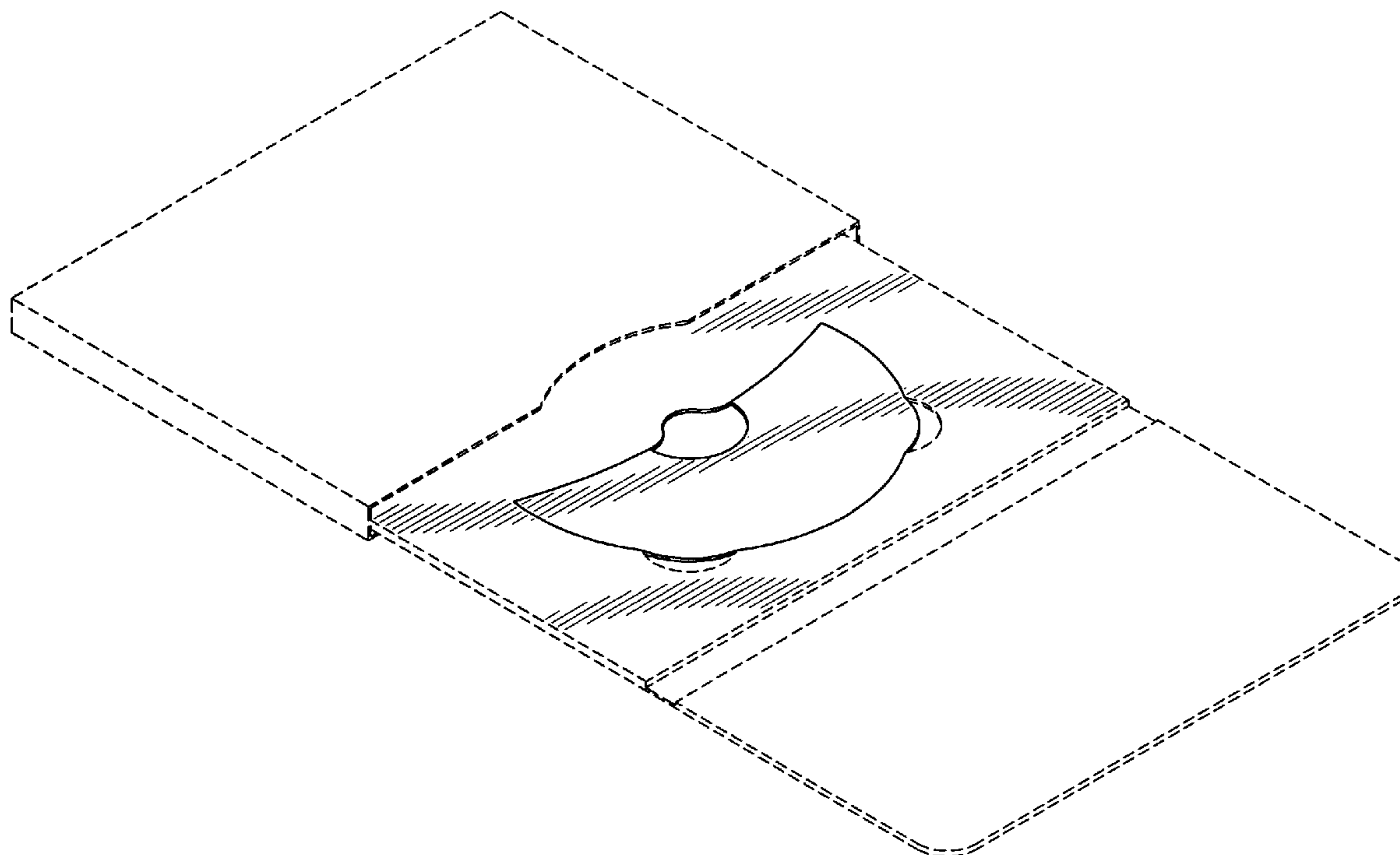

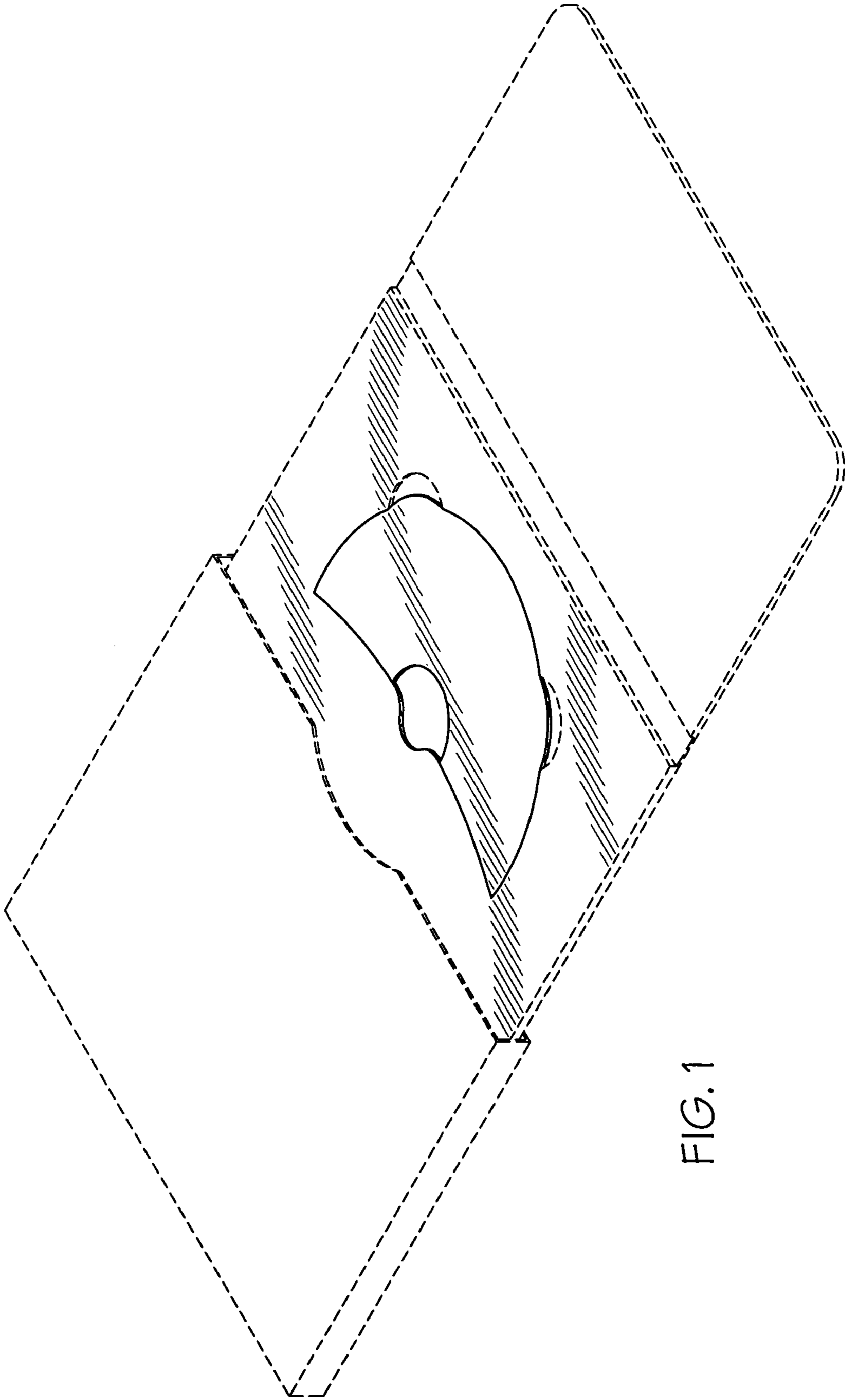

FIG. 1

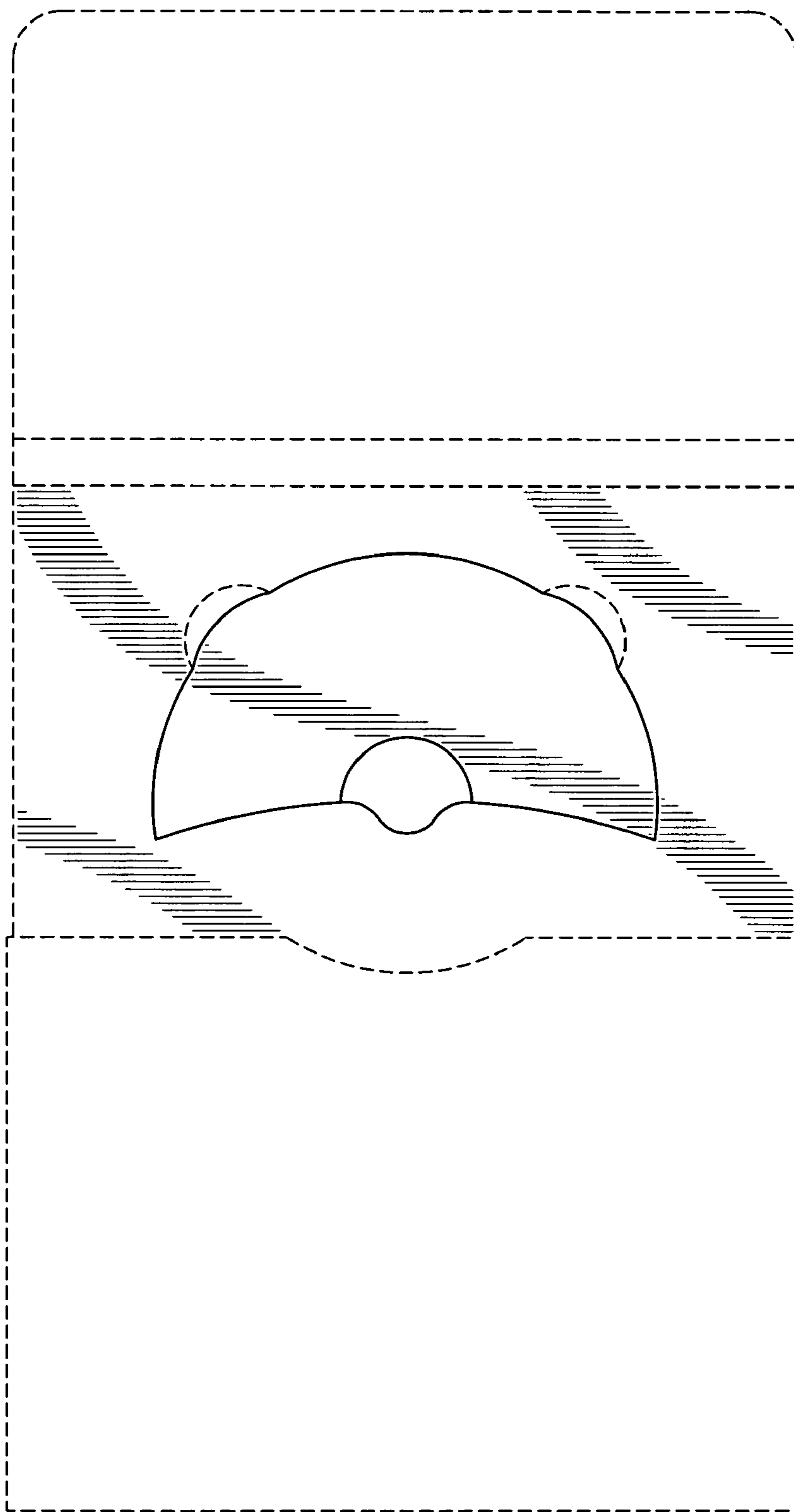

FIG. 2

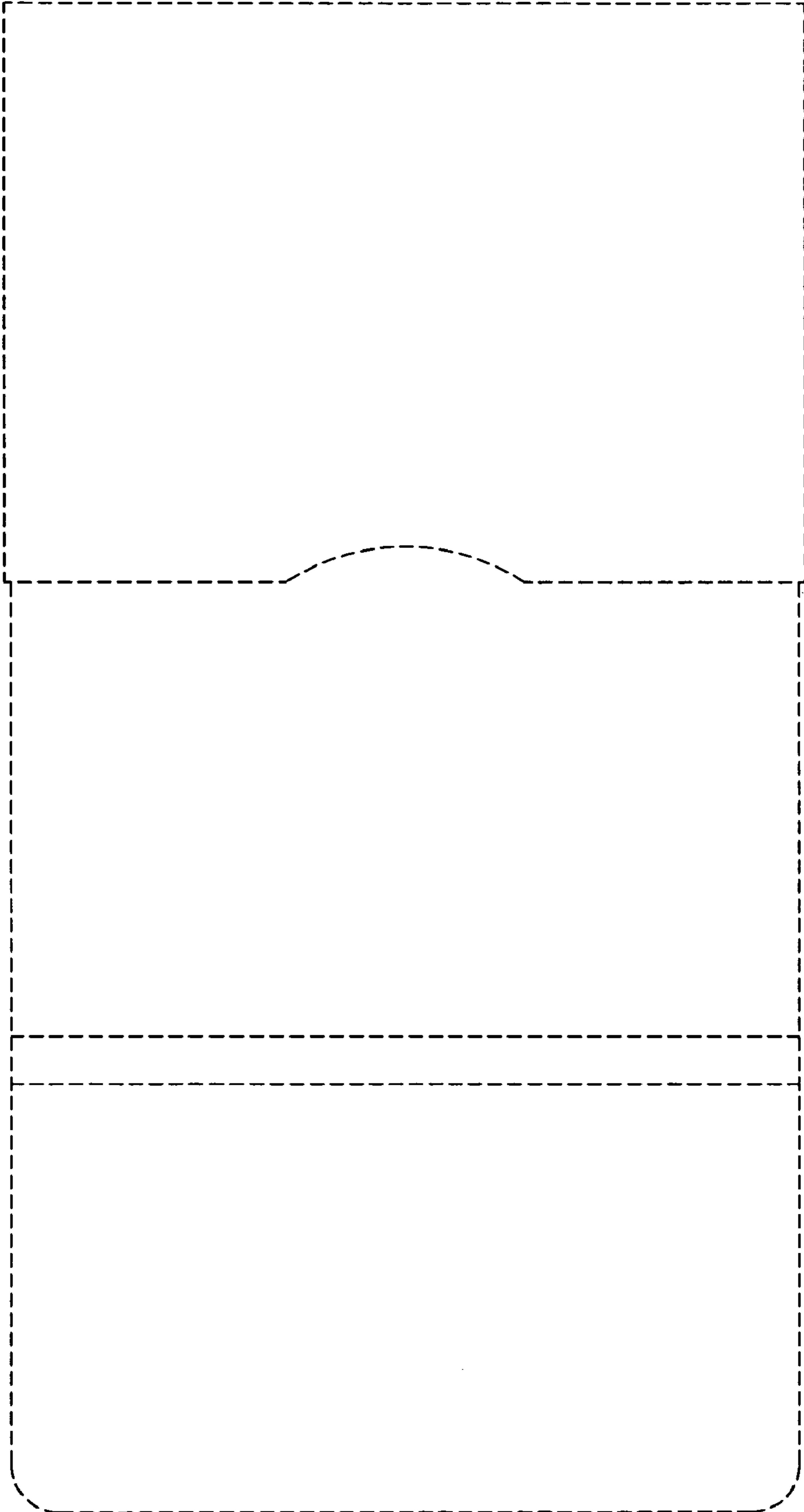

FIG. 3

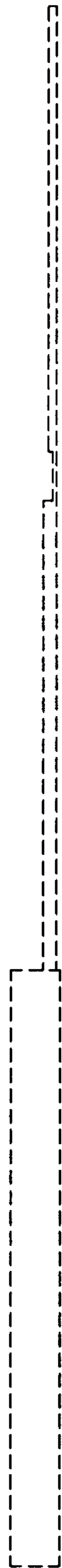

FIG. 4

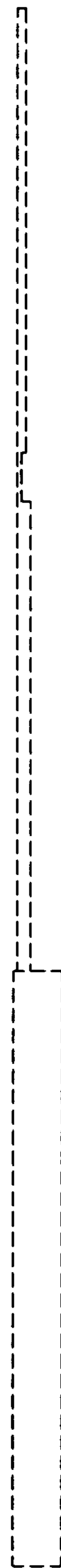

FIG. 5

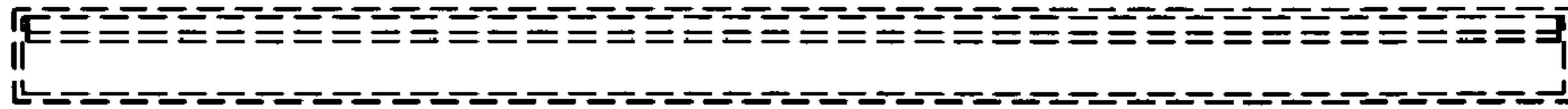

FIG. 7

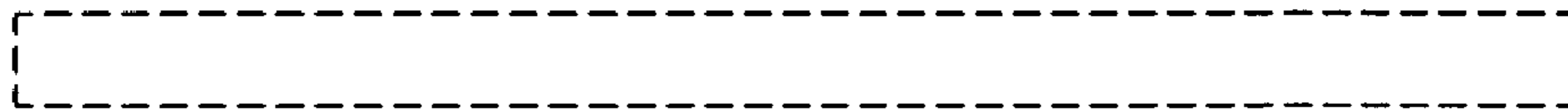

FIG. 6