



US00D599129S

(12) **United States Design Patent**  
**Opsvik**

(10) **Patent No.:** **US D599,129 S**

(45) **Date of Patent:** **\*\* Sep. 1, 2009**

(54) **CHAIR**

(76) Inventor: **Peter Opsvik**, Josefinegate 40, Oslo  
(NO) 0258

(\*\*) Term: **14 Years**

(21) Appl. No.: **29/276,358**

(22) Filed: **Jan. 23, 2007**

(51) **LOC (9) Cl.** ..... **06-01**

(52) **U.S. Cl.** ..... **D6/380**

(58) **Field of Classification Search** ..... D6/379-381,  
D6/334-336, 360, 368-370, 373-376, 499-500,  
D6/501-502, 366, 371-372; 297/452.63,  
297/452.64, 452.46, 411.43, 411.42, 446.1,  
297/445.1, 448.2

See application file for complete search history.

(56) **References Cited**

**U.S. PATENT DOCUMENTS**

2,713,385	A *	7/1955	McQuilkin	.....	297/45
D214,315	S *	6/1969	Bartholomew	.....	D6/374
D297,890	S *	10/1988	Hockenberry et al.	.....	D6/367
D352,185	S *	11/1994	Pagnon et al.	.....	D6/380
D426,970	S *	6/2000	Kolberg	.....	D6/374
6,106,061	A *	8/2000	Caruso et al.	.....	297/239
D481,550	S *	11/2003	Astle	.....	D6/374
D502,331	S *	3/2005	Socha et al.	.....	D6/374
D516,830	S *	3/2006	Leist et al.	.....	D6/373
D541,068	S *	4/2007	Foster	.....	D6/374
D558,478	S *	1/2008	Rothe	.....	D6/373
D560,384	S *	1/2008	Stauber	.....	D6/374
D565,856	S *	4/2008	Kimmel	.....	D6/374
D569,644	S *	5/2008	Kumazawa	.....	D6/372

\* cited by examiner

*Primary Examiner*—Elizabeth A Albert  
*Assistant Examiner*—Kelley A Donnelly  
(74) *Attorney, Agent, or Firm*—Volpe and Koenig, P.C.

(57) **CLAIM**

The ornamental design for a chair, as shown and described.

**DESCRIPTION**

FIG. 1 is a front perspective view from above and one side of the chair according to the invention, the chair having a seat and back rest unit mounted on a chair subframe;

FIG. 2 is a front view of the chair shown in FIG. 1;

FIG. 3 is a rear view of the chair;

FIG. 4 is a side view of the chair from one side;

FIG. 5 is a side view of the chair from the opposite side of that shown in FIG. 4;

FIG. 6 is a top view of the chair;

FIG. 7 is a bottom view of the chair;

FIG. 8 is a rear perspective view of the chair from above and the opposite side of that shown in FIG. 1;

FIG. 9 is a rear perspective view of the chair from above and the same side as shown in FIG. 1;

FIG. 10 is a front perspective view of the chair from the opposite side of that shown in FIG. 1; and,

FIG. 11 is a rear perspective view of the chair from the same side as that shown in FIG. 1.

The broken lines are for purposes of illustration only and form no part of the claimed design.

**1 Claim, 10 Drawing Sheets**

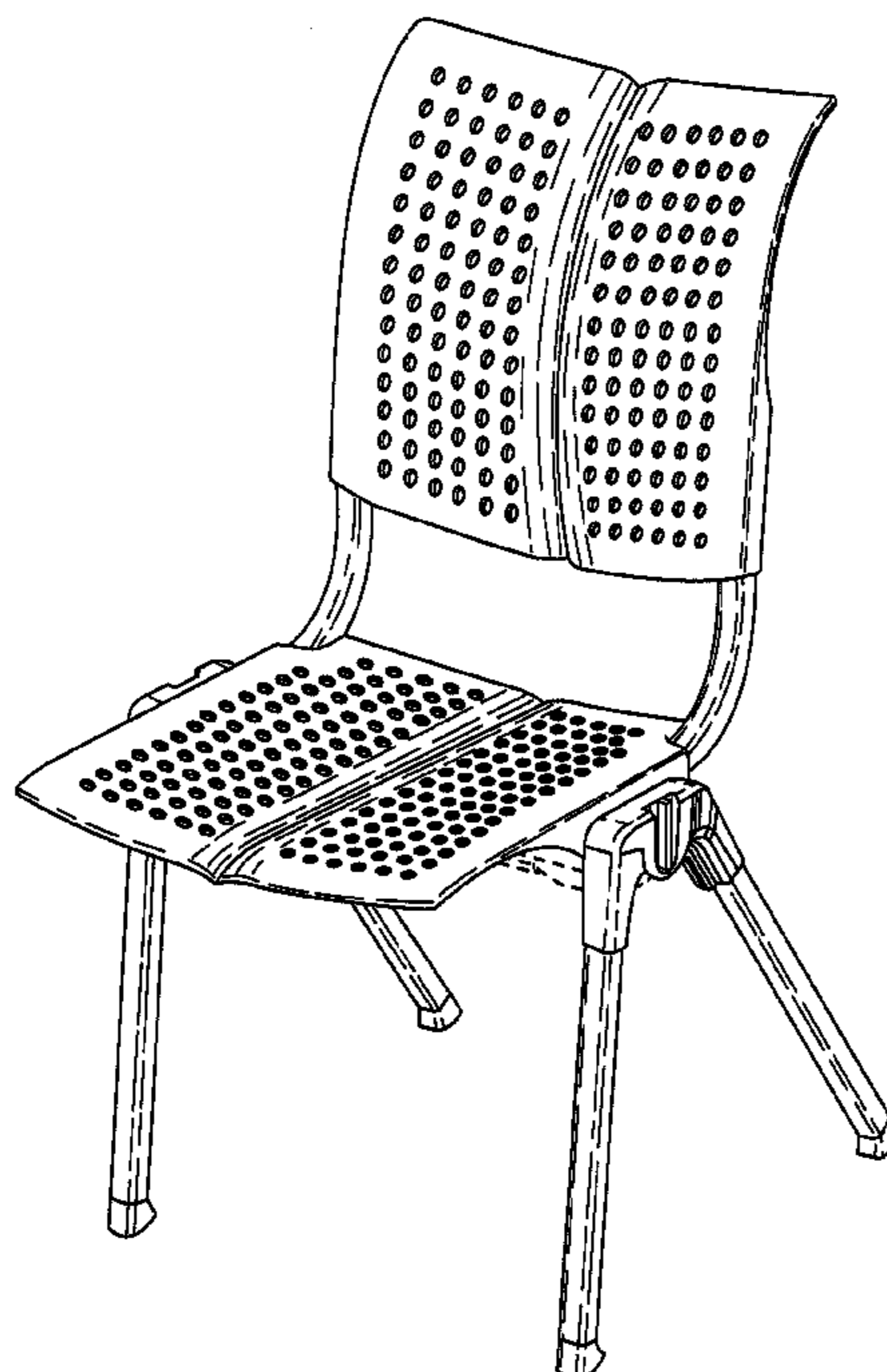

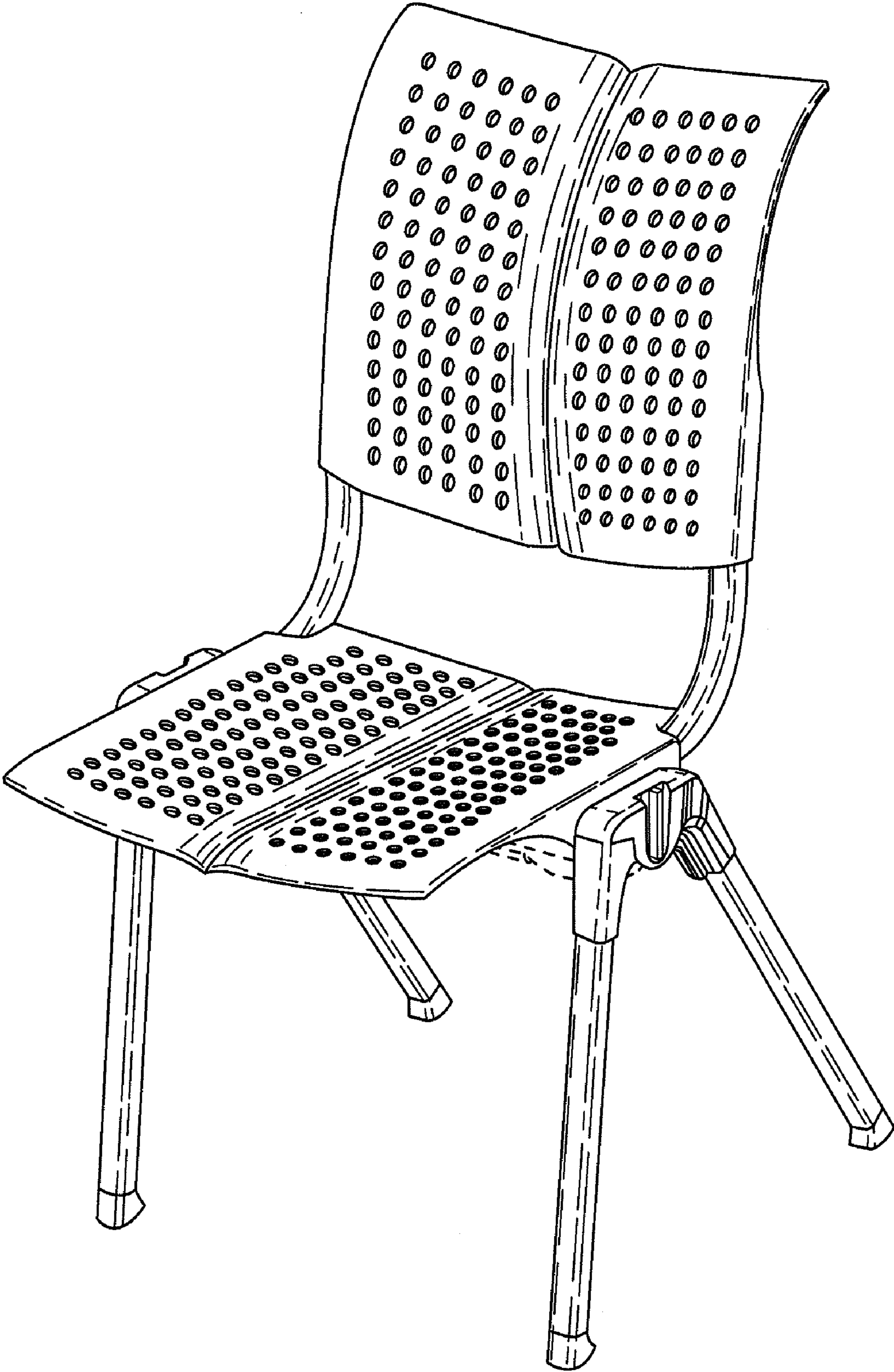

FIG. 1

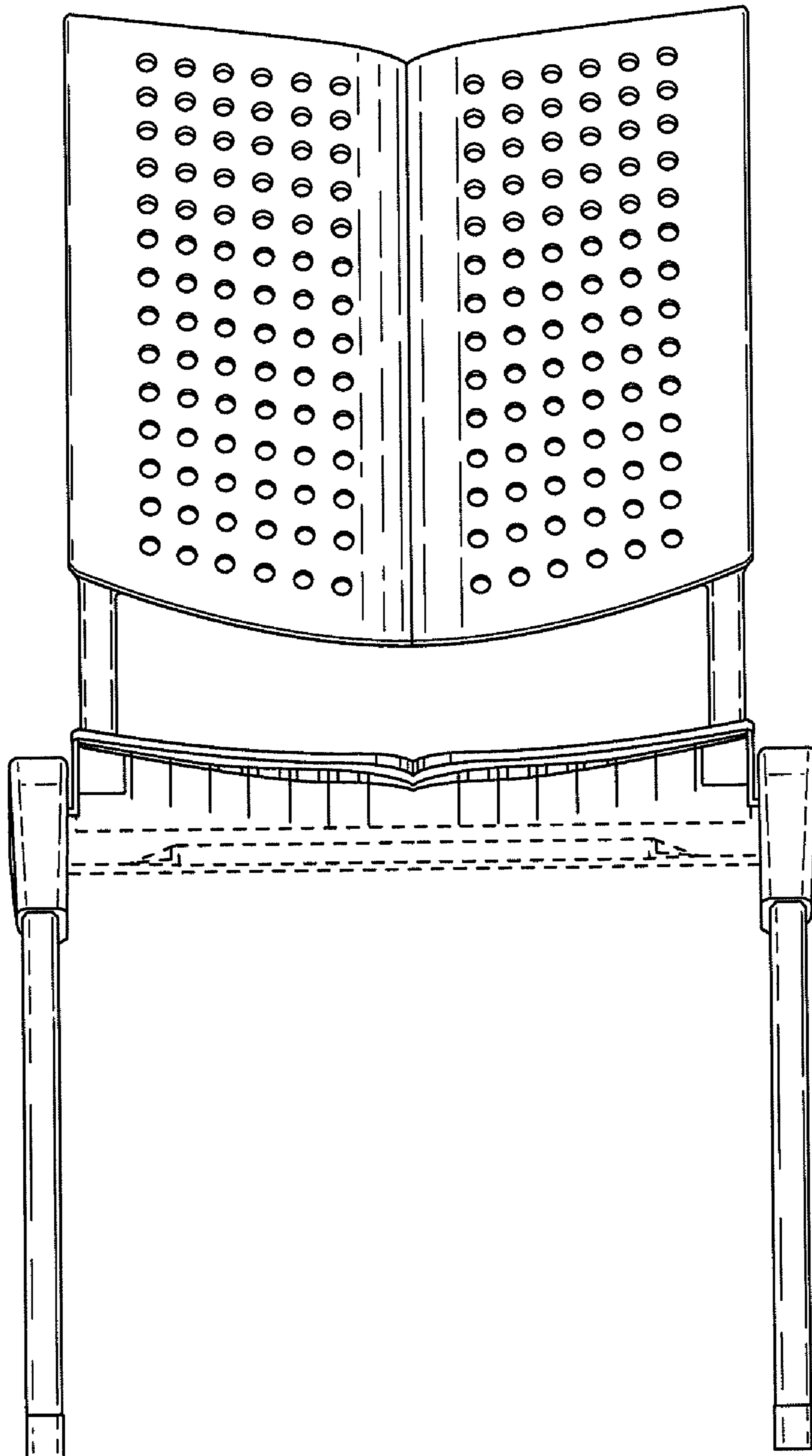

FIG. 2

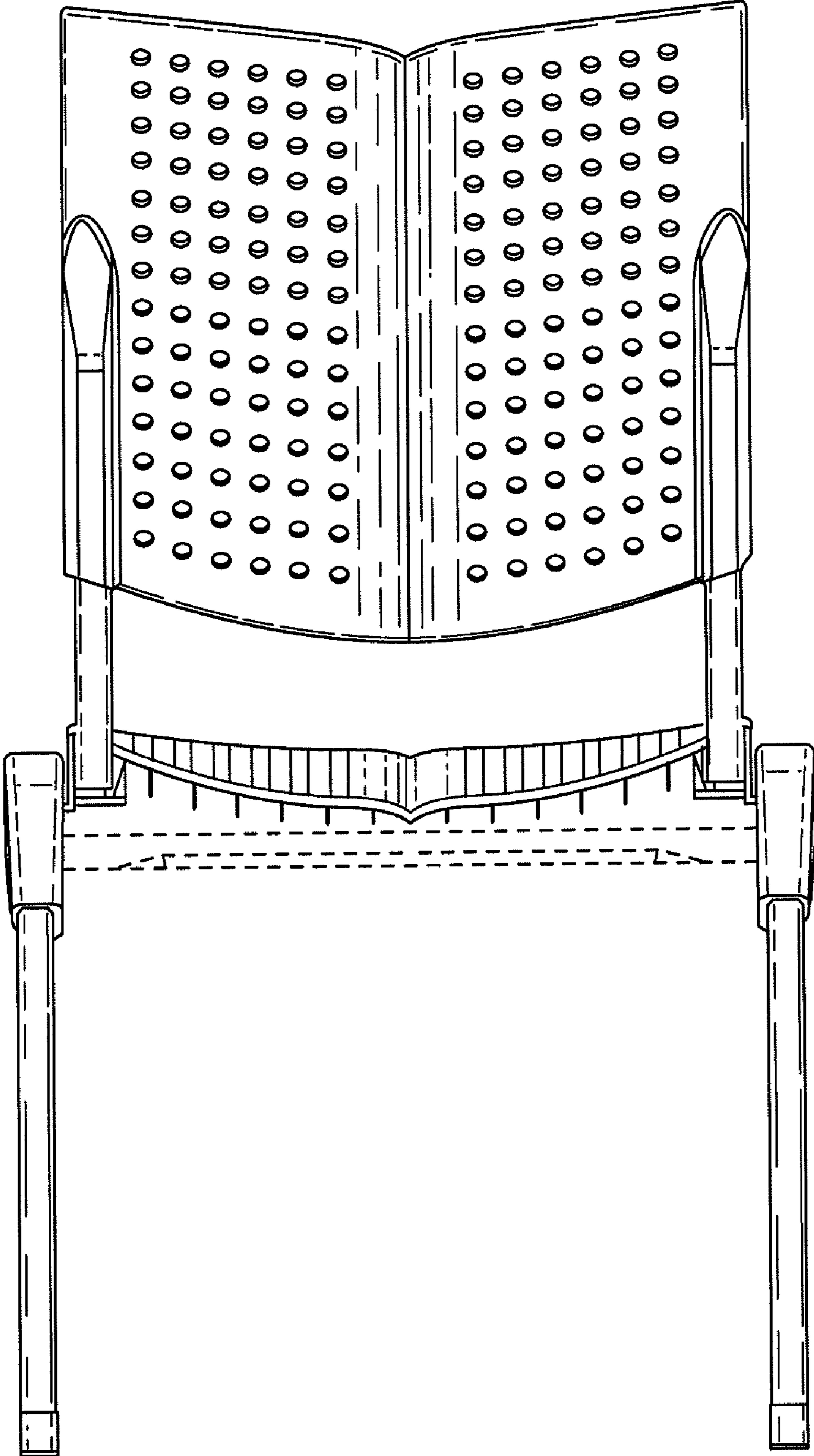

FIG. 3

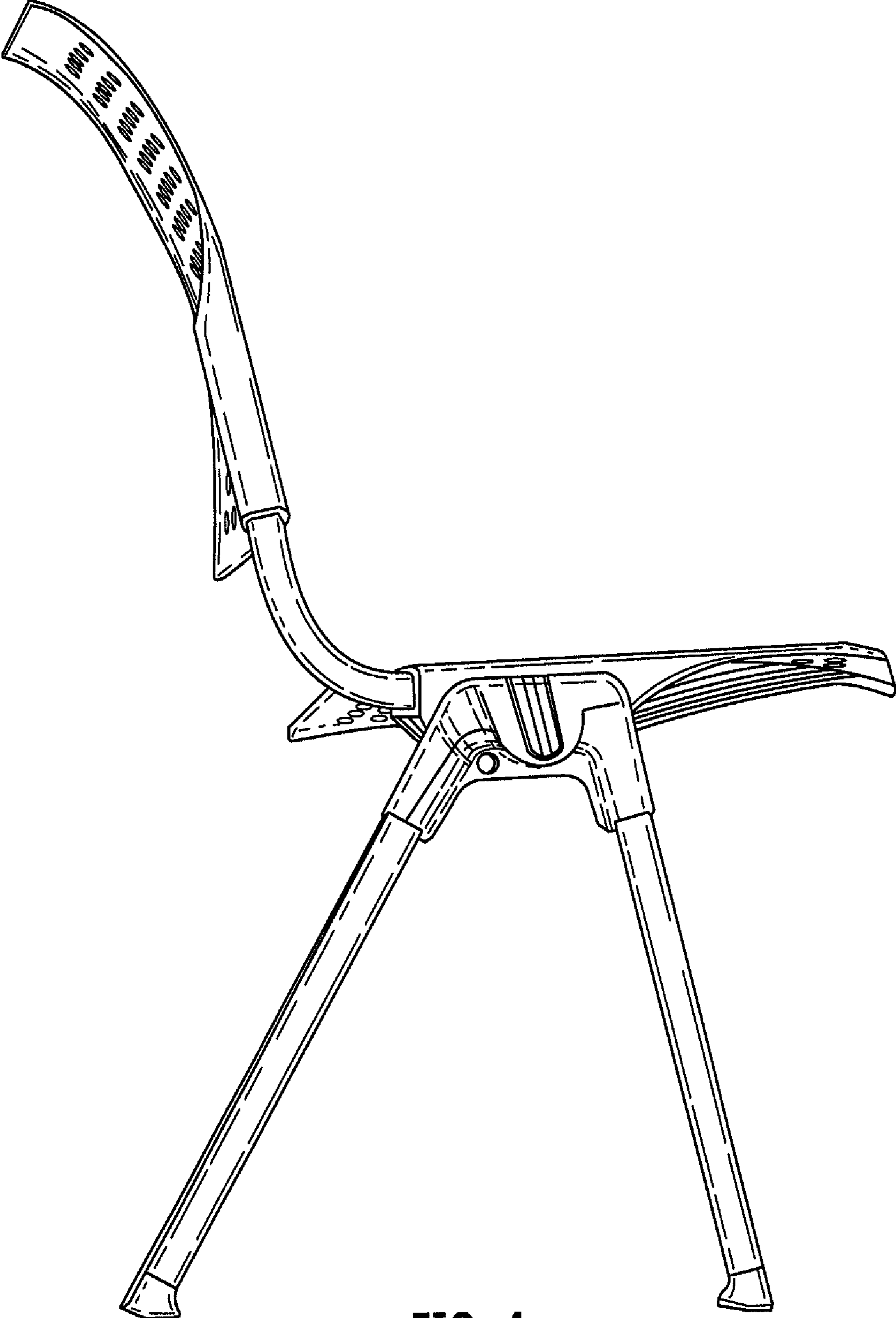

FIG. 4

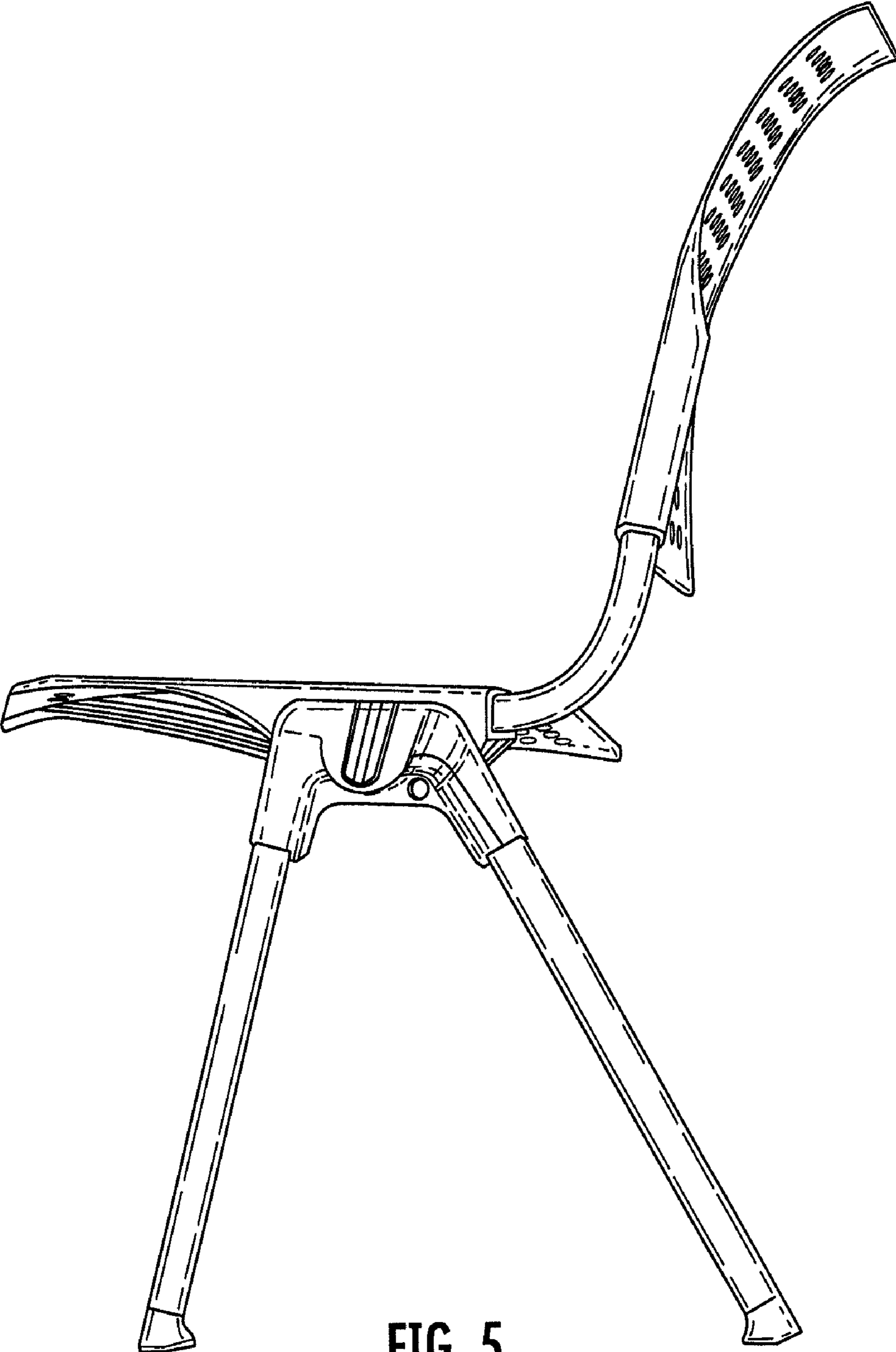

FIG. 5

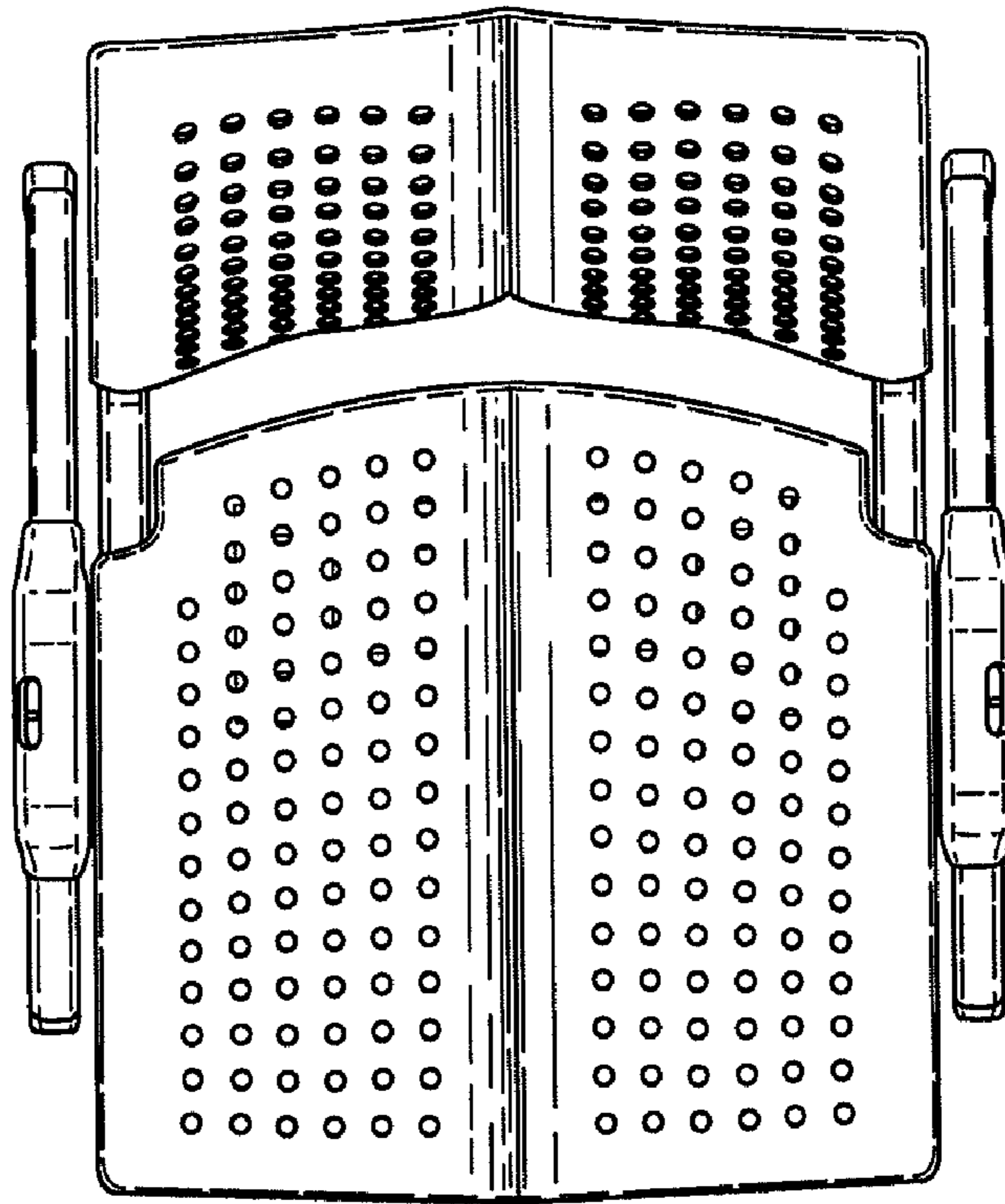

FIG. 6

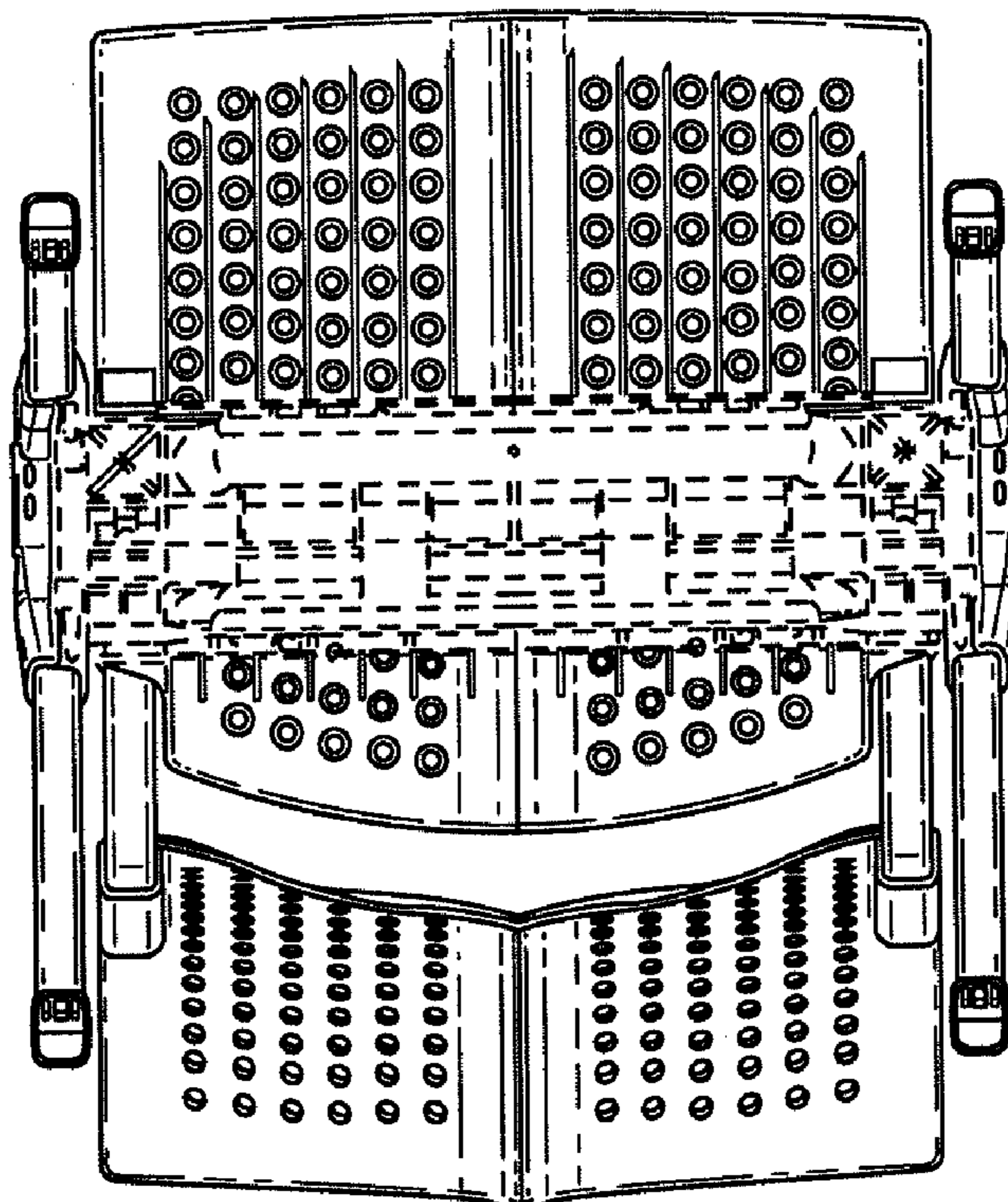

FIG. 7

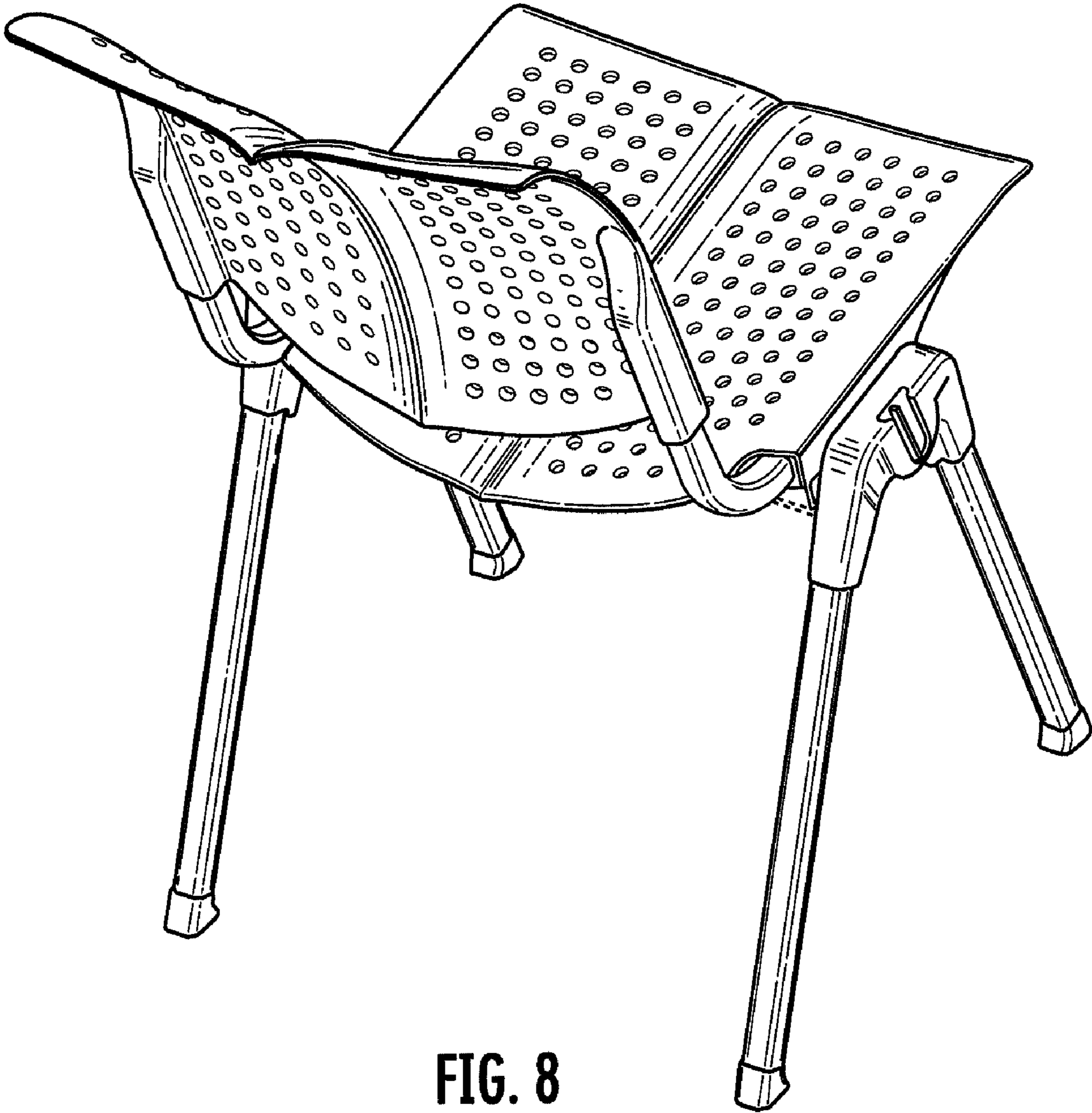

FIG. 8



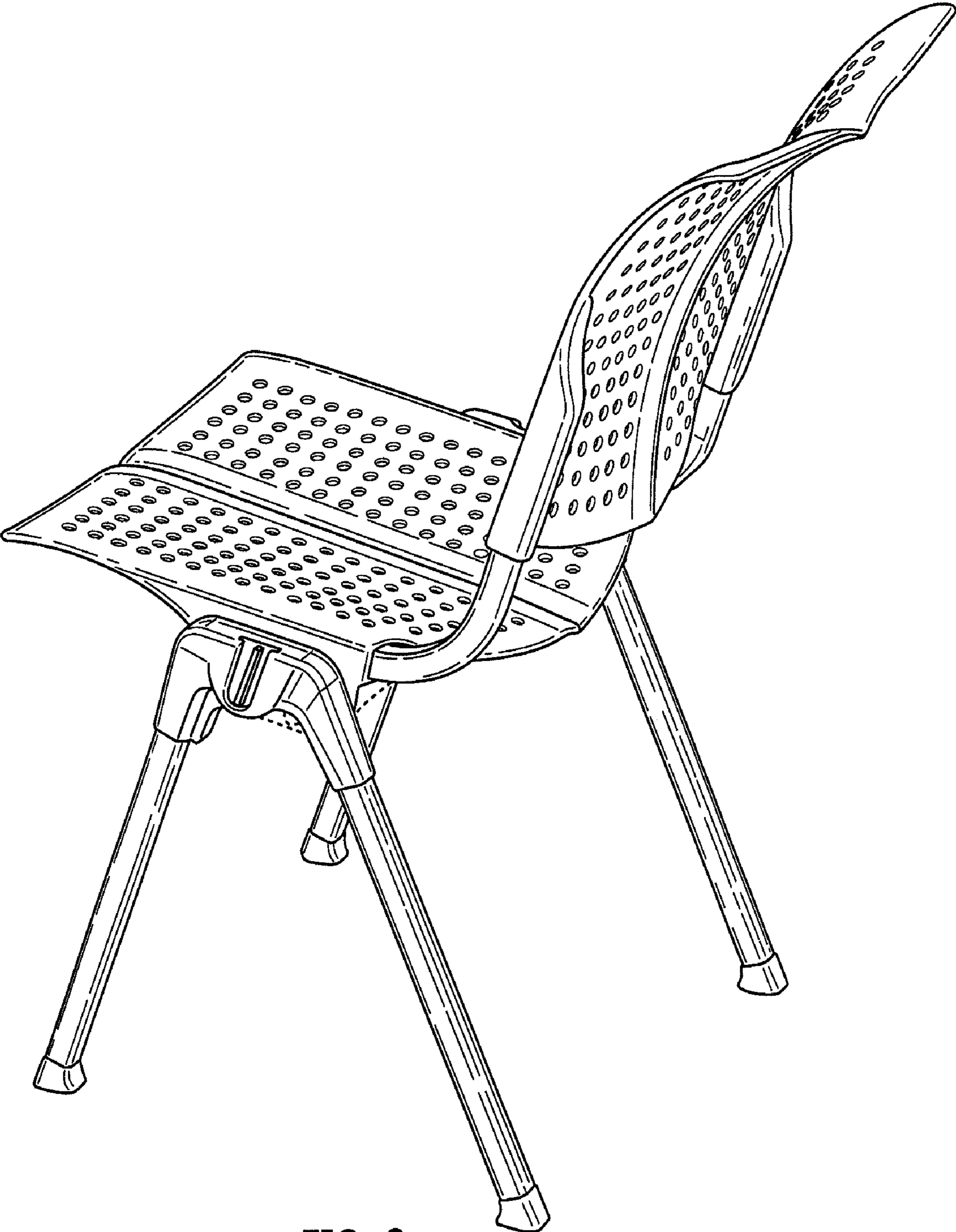

FIG. 9

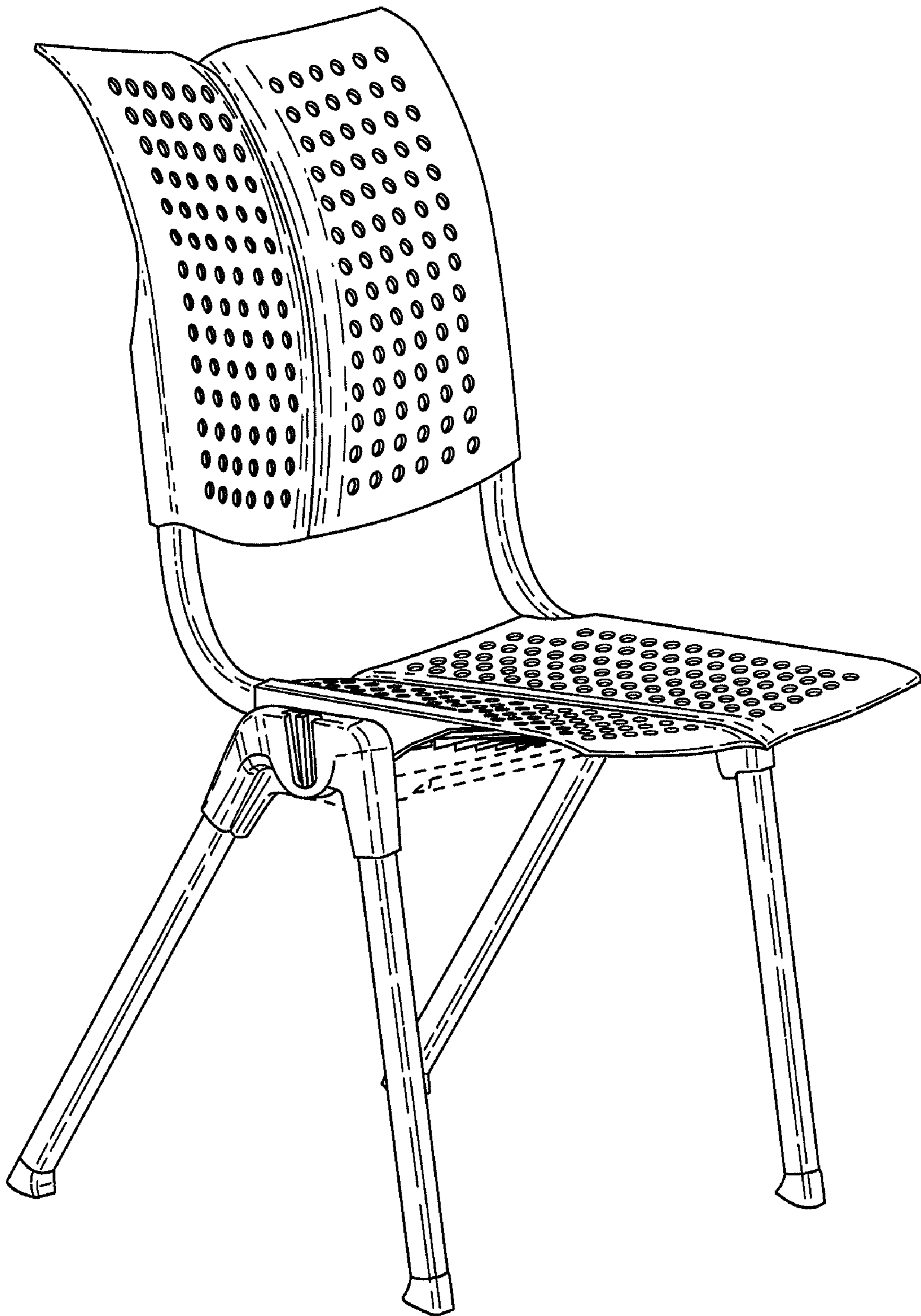

FIG. 10

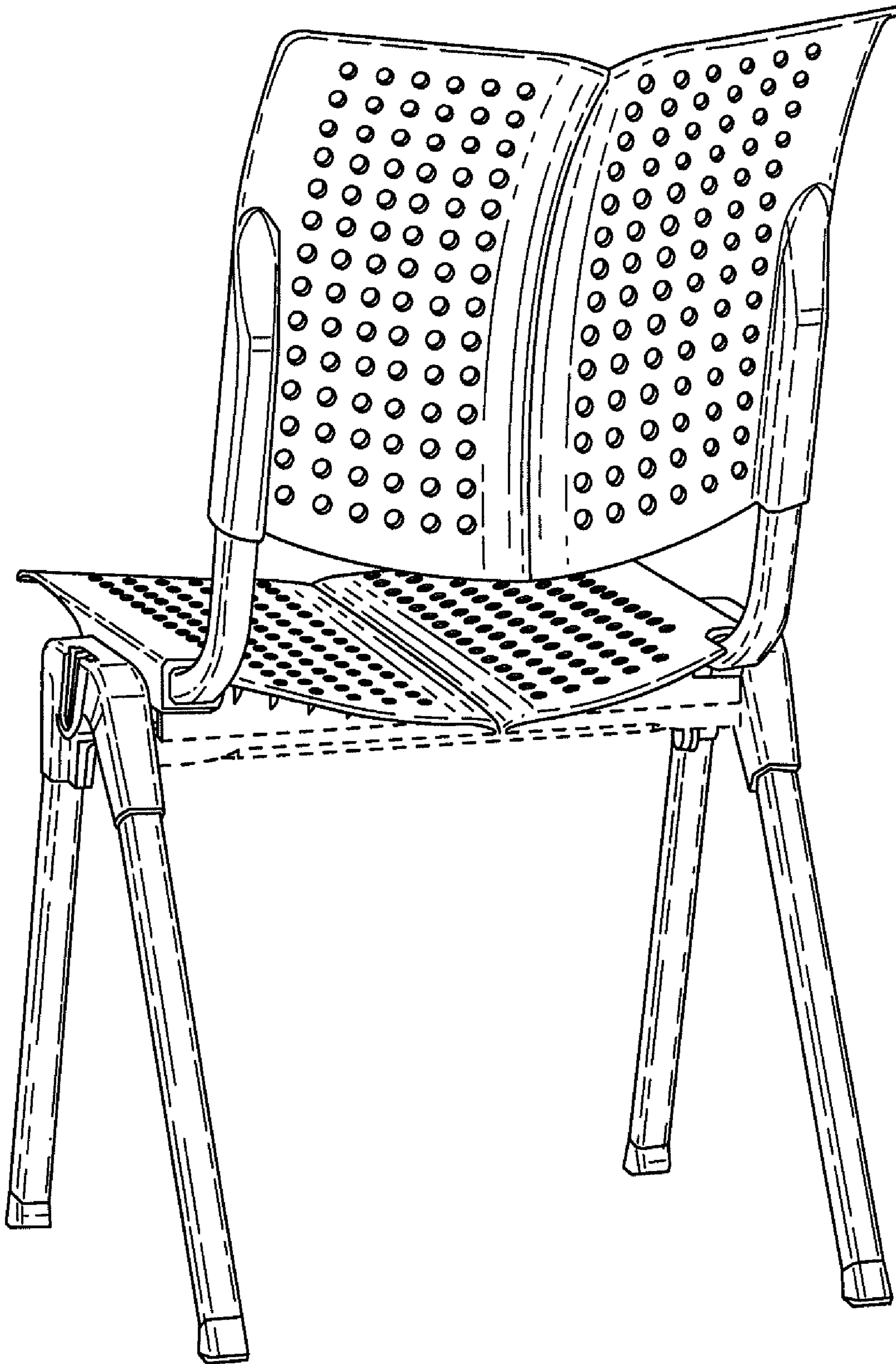

FIG. 11