



US00D599057S

(12) **United States Design Patent**
Beckholt et al.

(10) **Patent No.:** **US D599,057 S**

(45) **Date of Patent:** **** Aug. 25, 2009**

(54) **INDICIA FOR LAUNDRY TREATMENT PRODUCT**

(75) Inventors: **Dennis Allen Beckholt**, Fairfield, OH (US); **Susan Marie Seum**, Benton Harbor, MI (US); **Frank Emile Louis Triest**, Belgium (BE)

(73) Assignee: **The Procter & Gamble Company**, Cincinnati, OH (US)

(**) Term: **14 Years**

(21) Appl. No.: **29/307,981**

(22) Filed: **May 21, 2008**

(51) **LOC (9) Cl.** **28-02**

(52) **U.S. Cl.** **D28/8.1**

(58) **Field of Classification Search** 510/147,
510/192, 194, 220, 221, 223, 224, 294, 298,
510/439, 440-442, 447-450; D28/4, 5, 8.1,
D28/8.2; D24/101-103; D9/432

See application file for complete search history.

(56) **References Cited**

U.S. PATENT DOCUMENTS

D490,567 S *	5/2004	McLeish	D28/8.1
D494,863 S *	8/2004	Hamuro et al.	D9/432
D532,685 S *	11/2006	Reussner	D9/432
D546,673 S *	7/2007	Mongeon et al.	D9/432
D554,501 S *	11/2007	Bone et al.	D9/432
D558,921 S *	1/2008	Schwartz et al.	D28/8.1
D559,439 S *	1/2008	Schwartz et al.	D28/8.1
D559,440 S *	1/2008	Schwartz et al.	D28/8.1
D562,496 S *	2/2008	Wiedemann	D28/8.1
D565,244 S *	3/2008	Schwartz et al.	D28/8.1
D566,545 S *	4/2008	Bone et al.	D9/432
D566,894 S *	4/2008	Wiedemann	D28/8.1
D567,080 S *	4/2008	Bone et al.	D9/432
D567,998 S *	4/2008	Wiedemann	D28/8.1
D576,353 S *	9/2008	McCarthy	D28/8.1

* cited by examiner

Primary Examiner—Jennifer Rivard

(74) *Attorney, Agent, or Firm*—Julia A. Glazer; Kim W. Zerby; Steven W. Miller

(57) **CLAIM**

The ornamental design for indicia for laundry treatment product, as shown and described.

DESCRIPTION

FIG. 1 is a perspective view of indicia for laundry treatment product showing my new design.

FIG. 2 is a top view of the indicia for laundry treatment product of FIG. 1.

FIG. 3 is a front view of the indicia for laundry treatment product of FIG. 1.

FIG. 4 is a left side view of the indicia for laundry treatment product of FIG. 1.

FIG. 5 is a right side view of the indicia for laundry treatment product of FIG. 1.

FIG. 6 is a back view of the indicia for laundry treatment product of FIG. 1.

FIG. 7 is a bottom view of the indicia for laundry treatment product of FIG. 1.

FIG. 8 is a perspective view of the second embodiment for indicia for laundry treatment product.

FIG. 9 is a top view of the indicia for laundry treatment product of FIG. 8.

FIG. 10 is a bottom view of the indicia for laundry treatment product of FIG. 8.

FIG. 11 is a front view of the indicia for laundry treatment product of FIG. 8.

FIG. 12 is a left side view of the indicia for laundry treatment product of FIG. 8.

FIG. 13 is a right side view of the indicia for laundry treatment product of FIG. 8.

FIG. 14 is a back view of the indicia for laundry treatment product of FIG. 8.

FIG. 15 is a perspective view of the third embodiment for indicia for laundry treatment product.

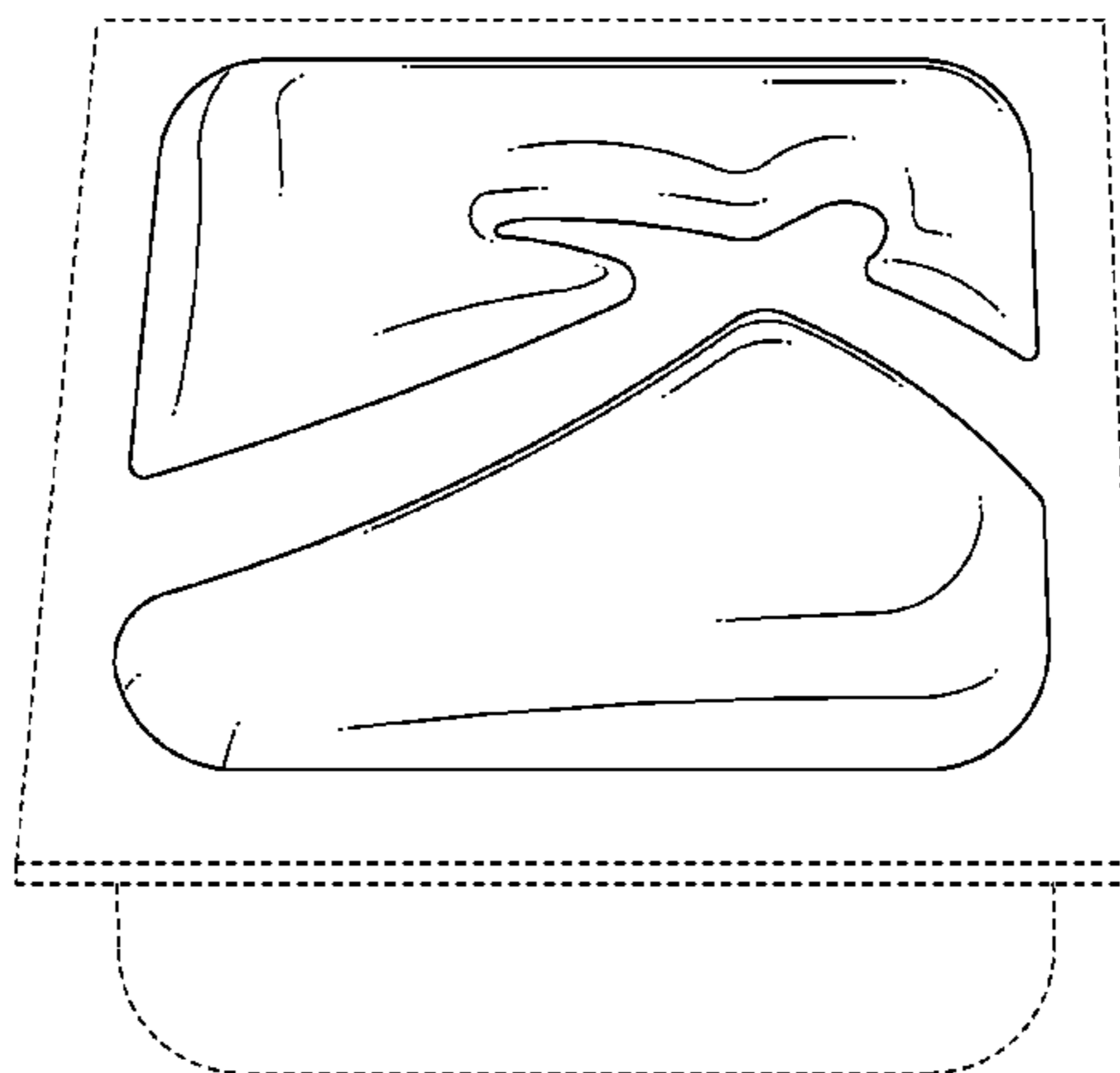

FIG. 16 is a top view of the indicia for laundry treatment product of FIG. 15.

FIG. 17 is a front view of the indicia for laundry treatment product of FIG. 15.

FIG. 18 is a left side view of the indicia for laundry treatment product of FIG. 15.

FIG. 19 is a right side view of the indicia for laundry treatment product of FIG. 15.

FIG. 20 is a back view of the indicia for laundry treatment product of FIG. 15.

FIG. 21 is a bottom view of the indicia for laundry treatment product of FIG. 15.

FIG. 22 is a perspective view of the fourth embodiment for indicia for laundry treatment product.

FIG. 23 is a top view of the indicia for laundry treatment product of FIG. 22.

FIG. 24 is a bottom view of the indicia for laundry treatment product of FIG. 22.

FIG. 25 is a front view of the indicia for laundry treatment product of FIG. 22.

FIG. 26 is a left side view of the indicia for laundry treatment product of FIG. 22.

FIG. 27 is a right side view of the indicia for laundry treatment product of FIG. 22; and,

FIG. 28 is a back view of the indicia for laundry treatment product of FIG. 22.

The broken lines which connect the ends of the full line disclosure in FIGS. 15–16 and 22–23 define the bounds of the claimed design. All other broken lines represent environmental structure. None of the broken lines form part of the claimed design.

1 Claim, 14 Drawing Sheets

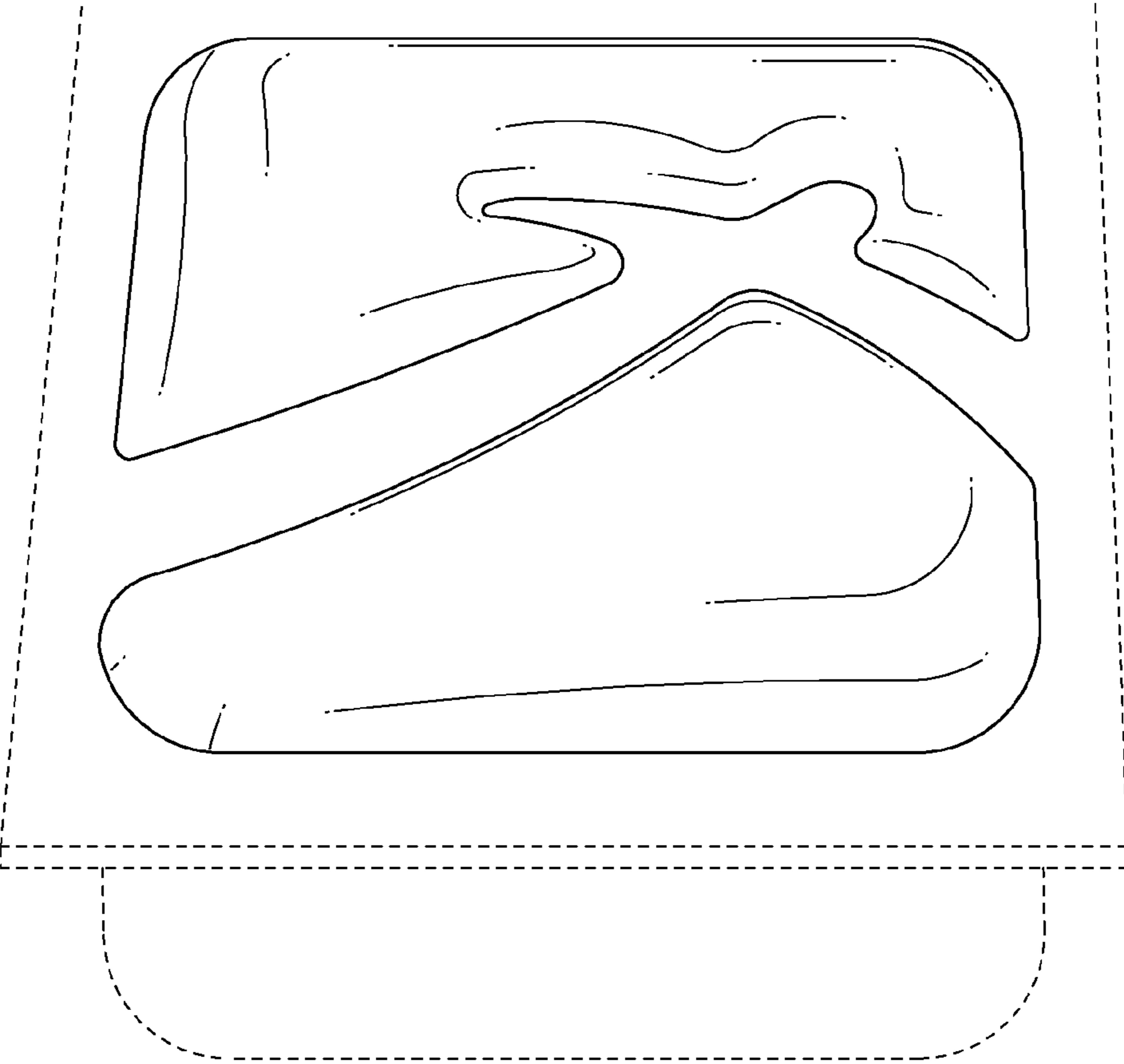

FIG. 1

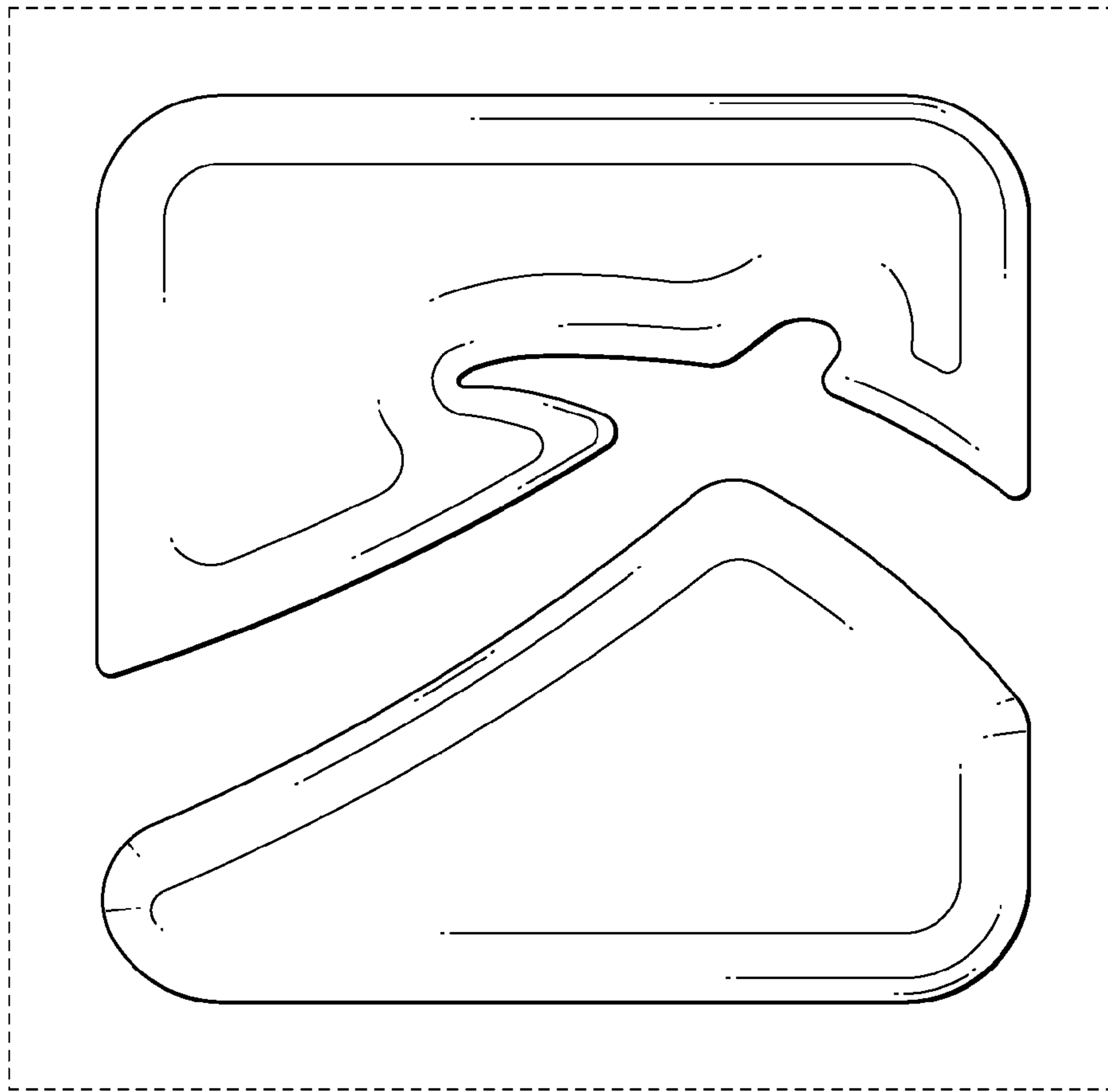

FIG. 2

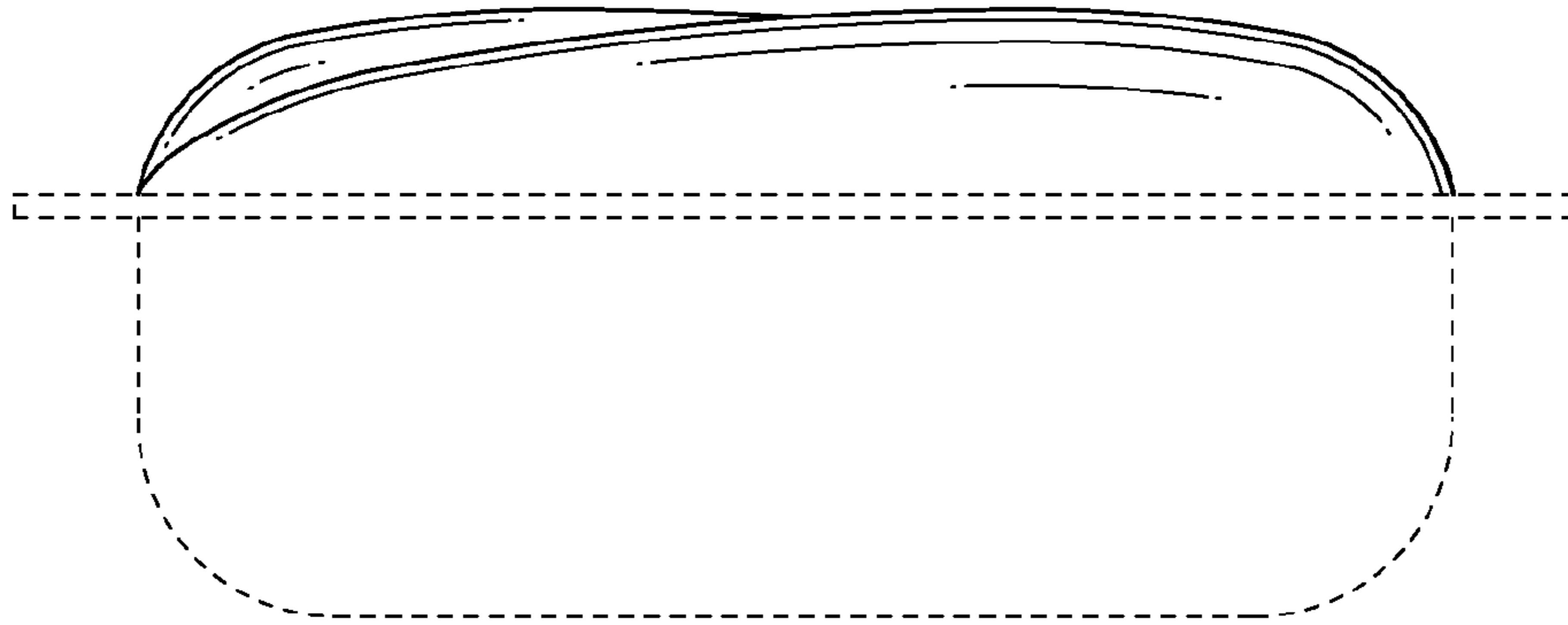

FIG. 3

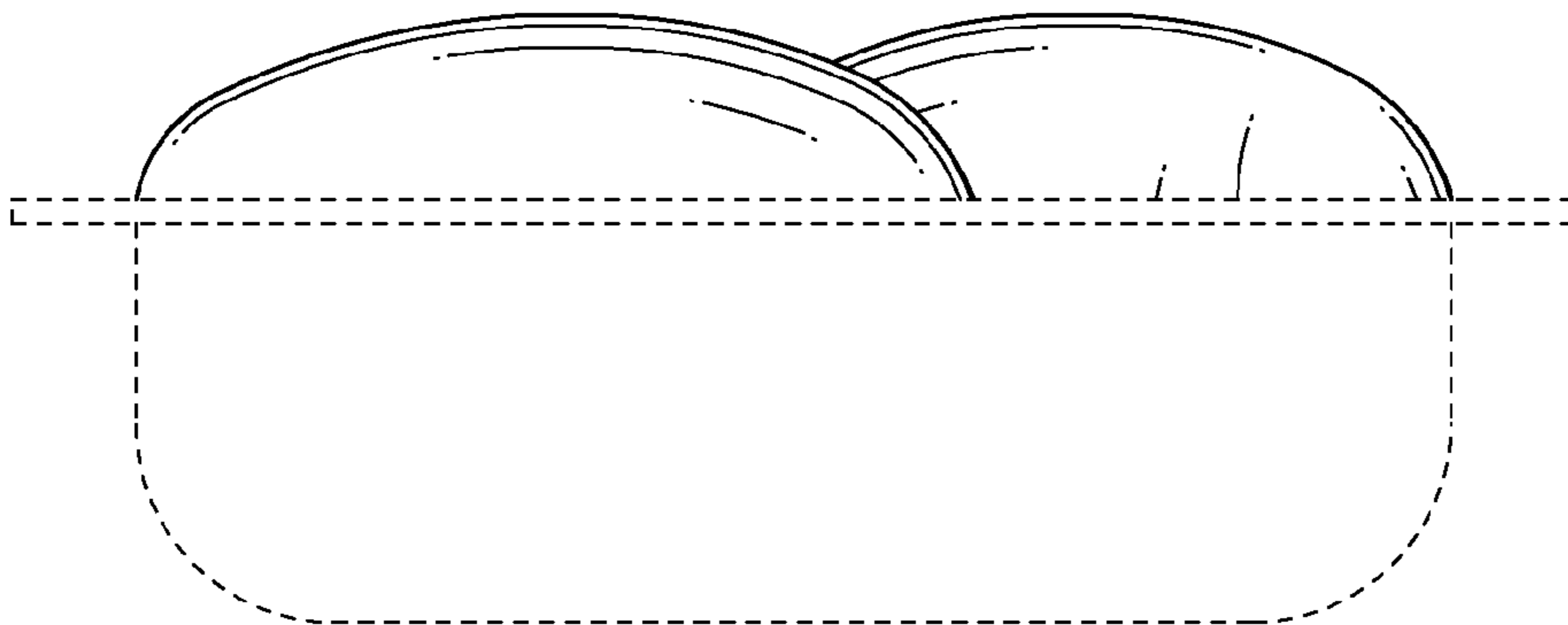

FIG. 4

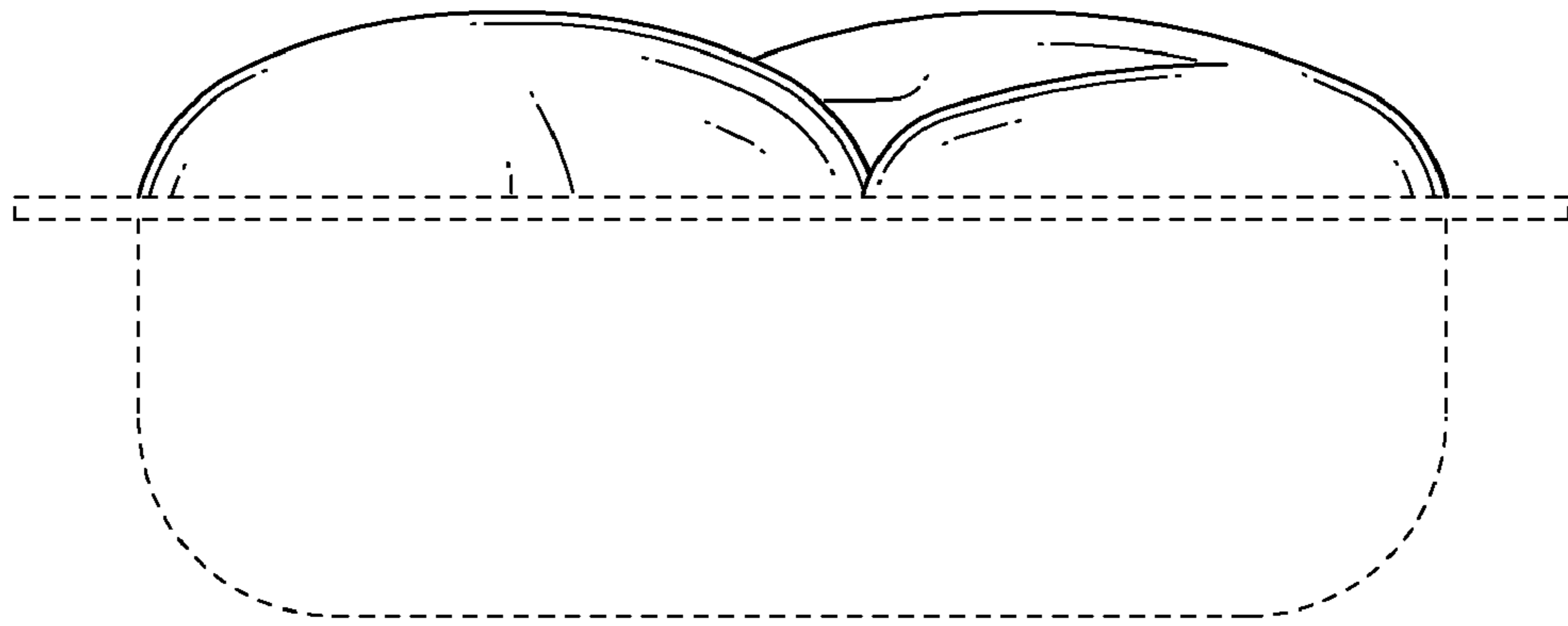

FIG. 5

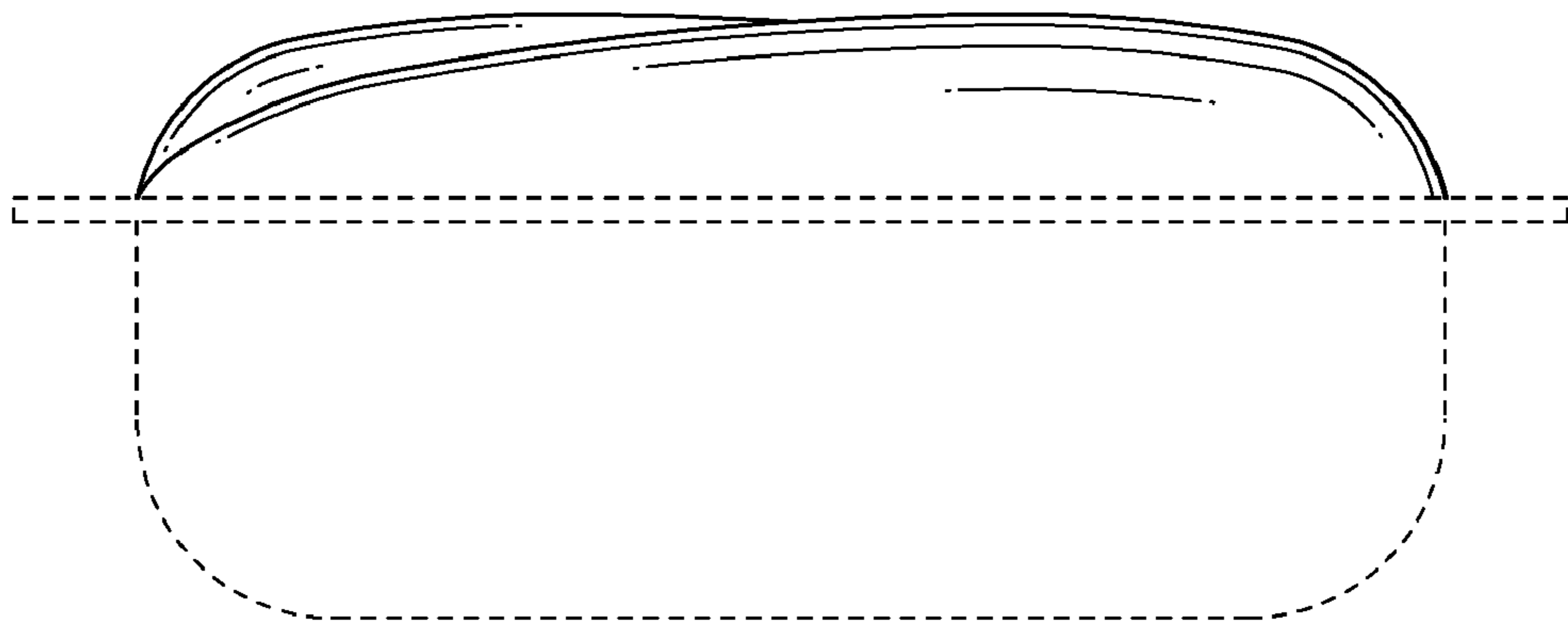

FIG. 6

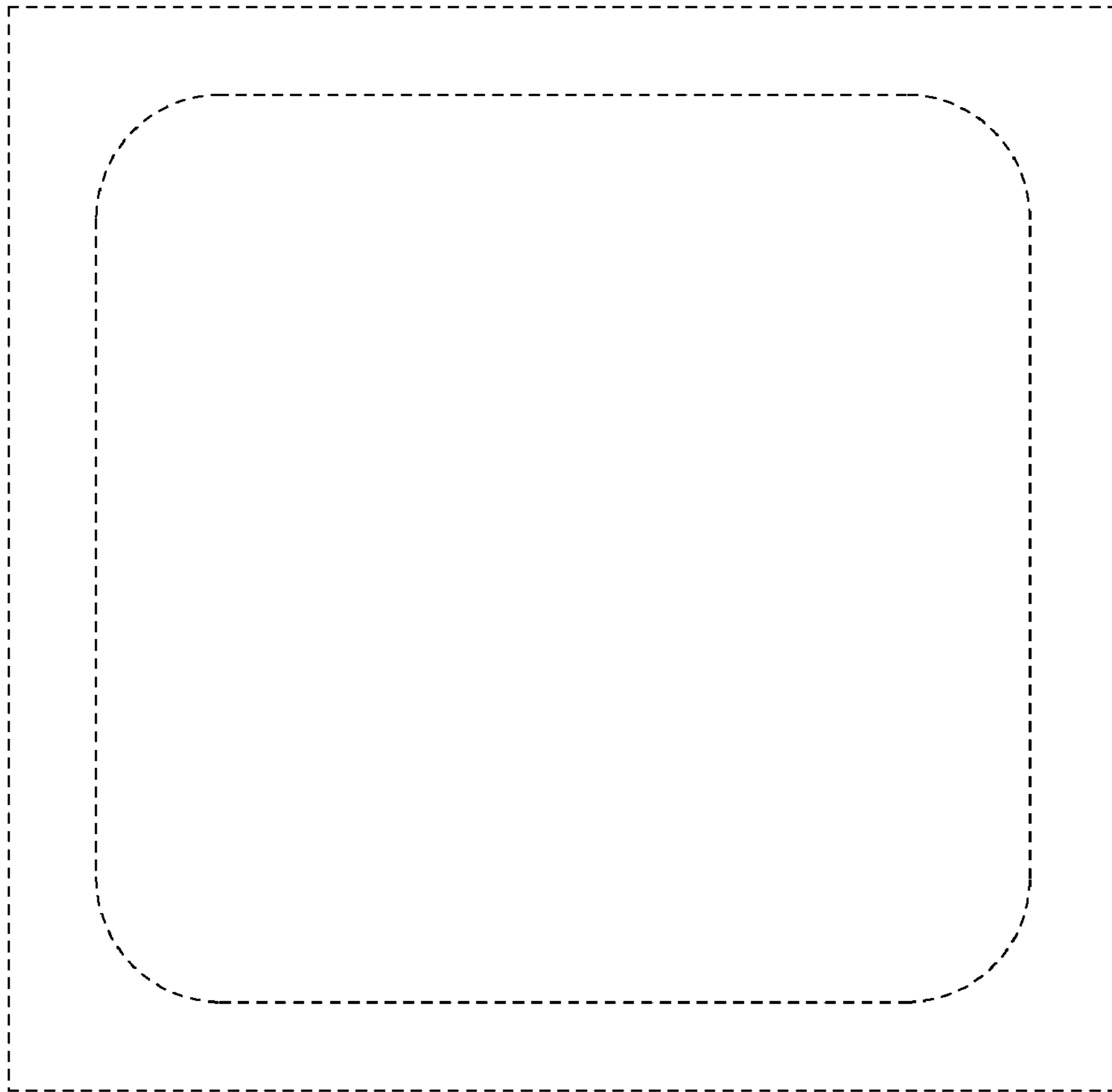

FIG. 7

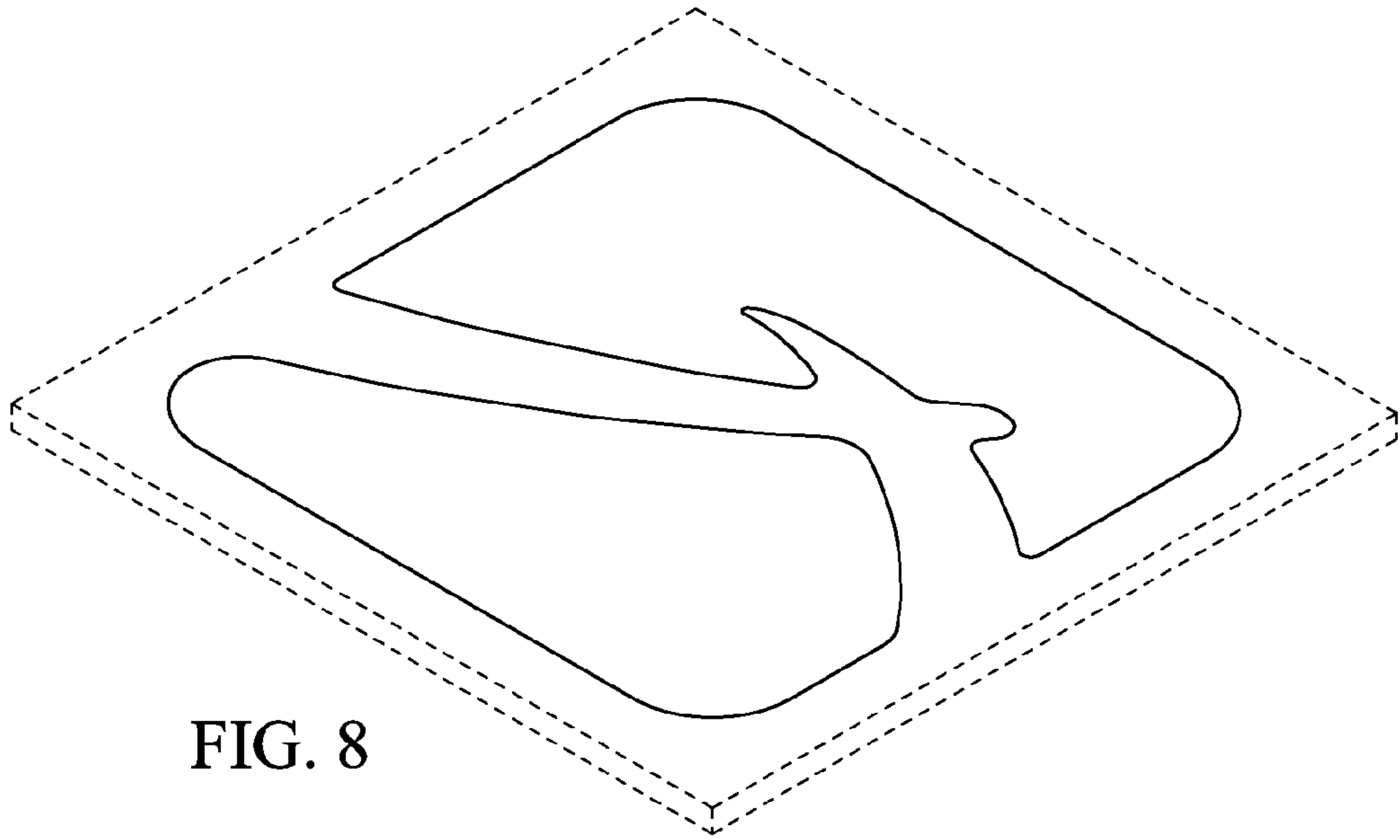

FIG. 8

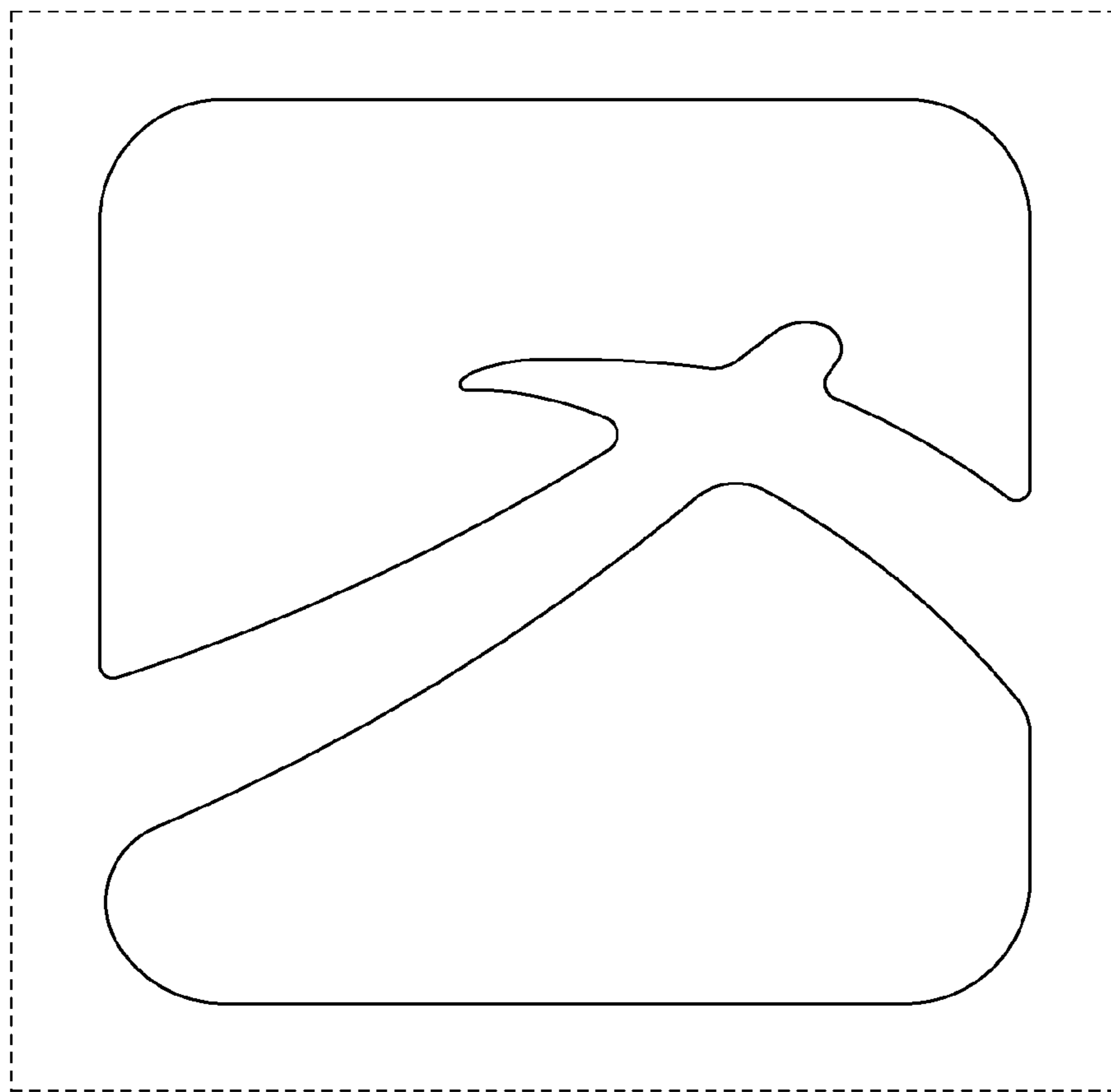

FIG. 9

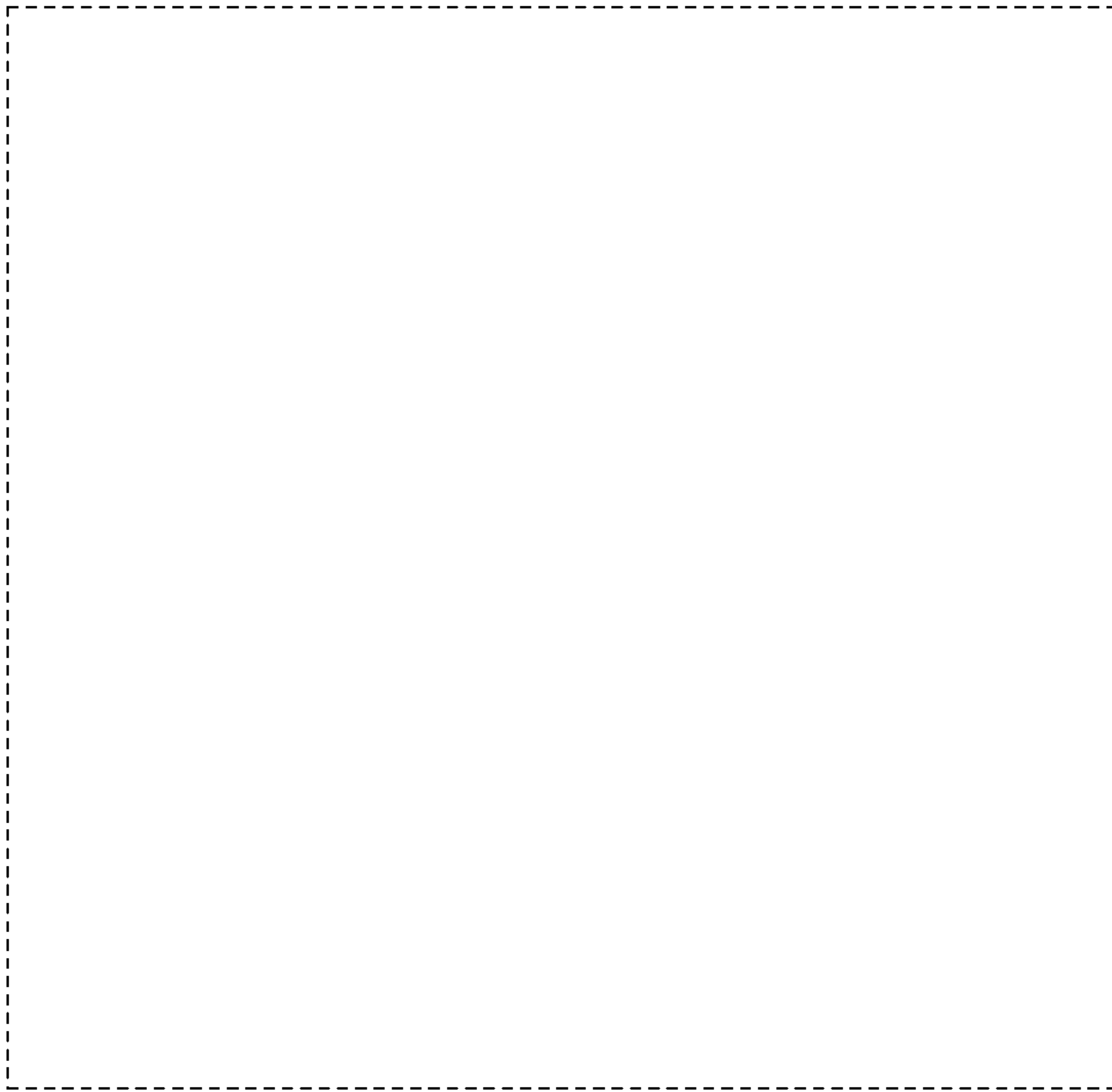

FIG. 10

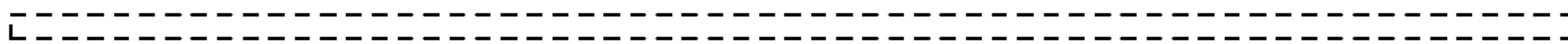

FIG. 11

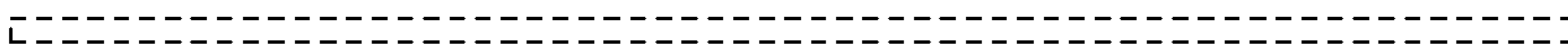

FIG. 12

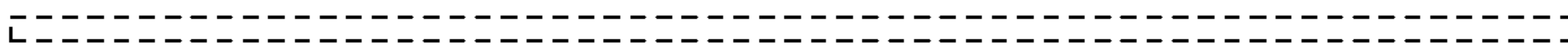

FIG. 13

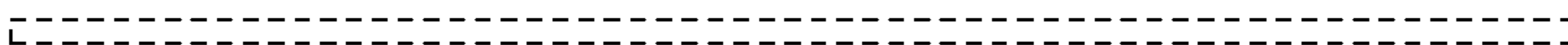

FIG. 14

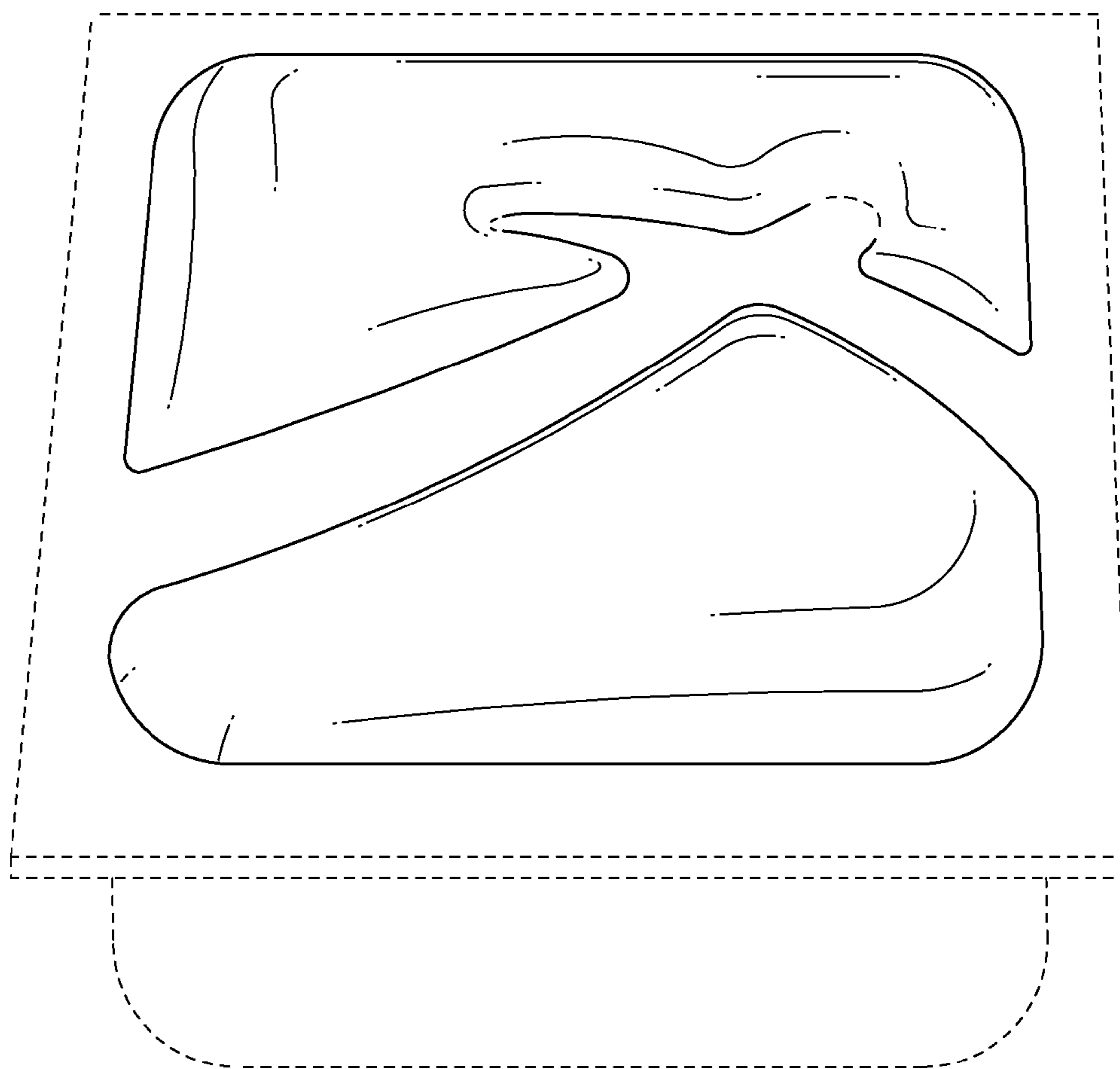

FIG. 15

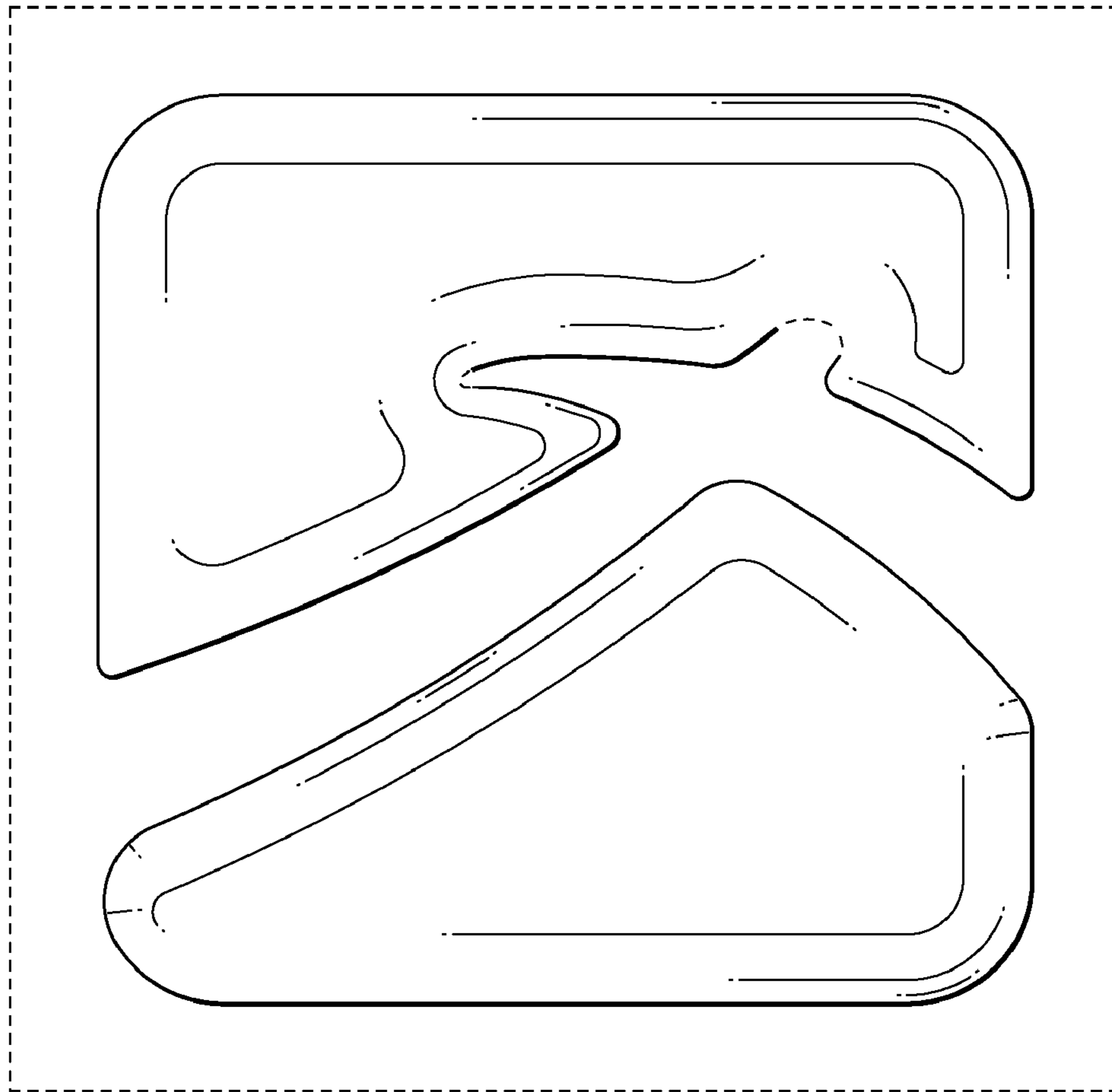

FIG. 16

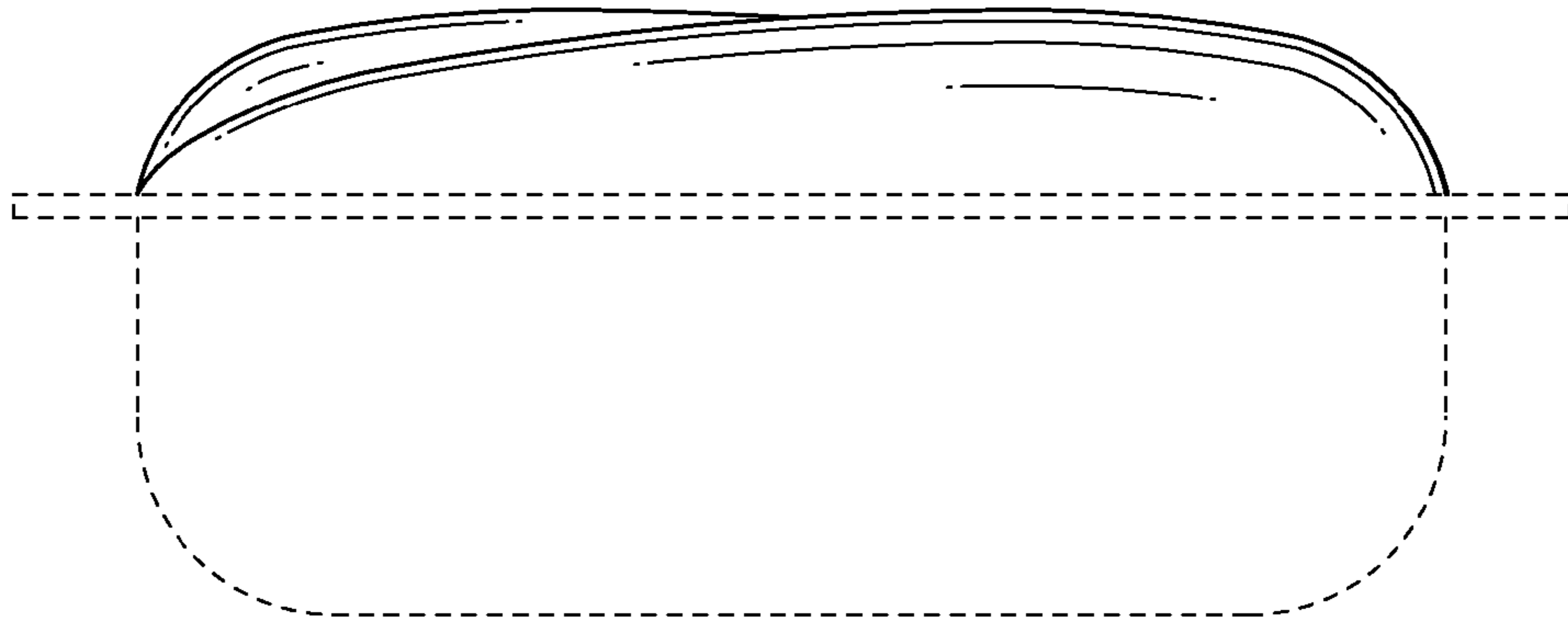

FIG. 17

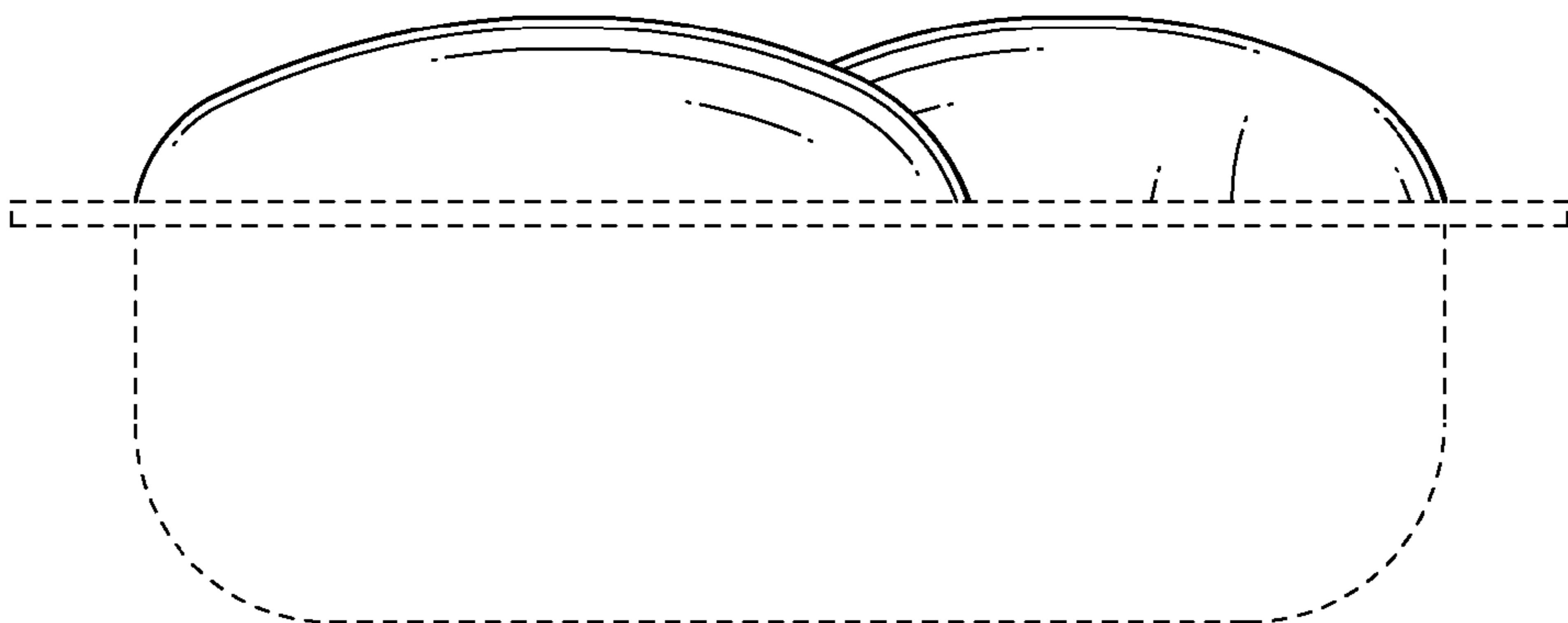

FIG. 18

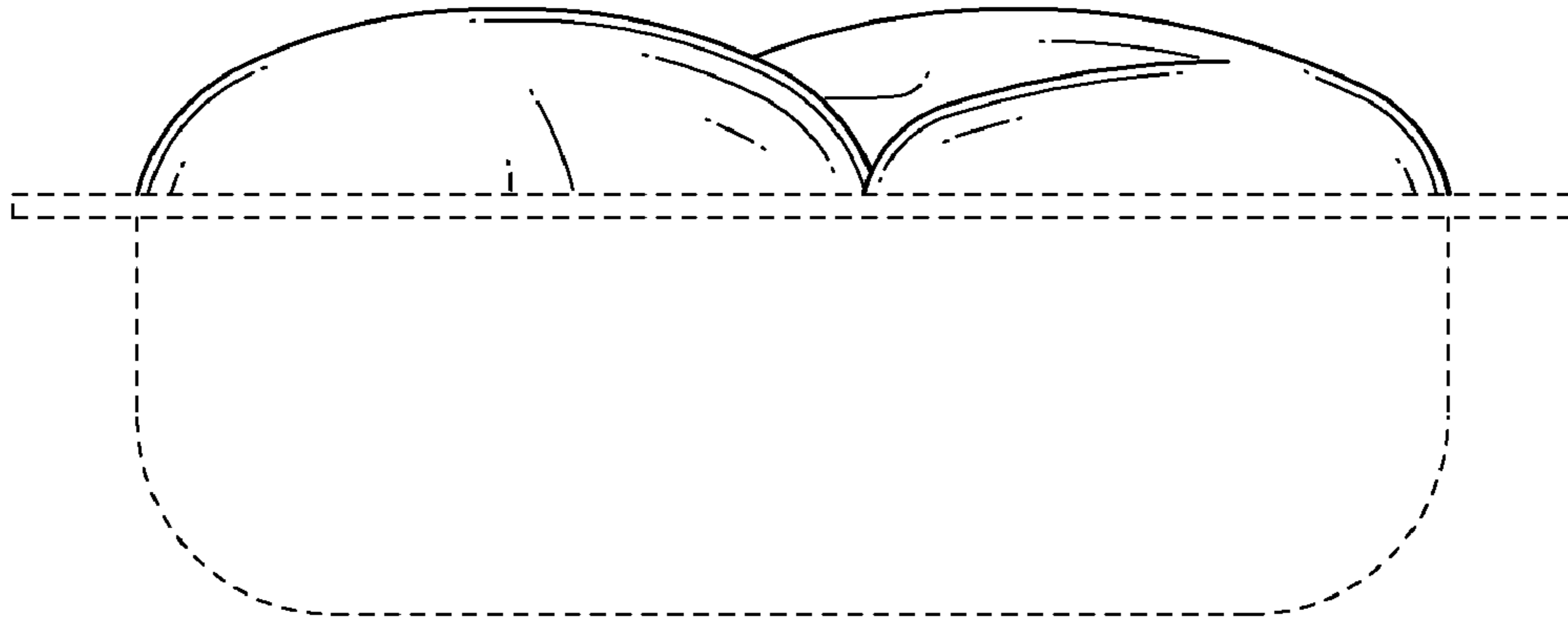

FIG. 19

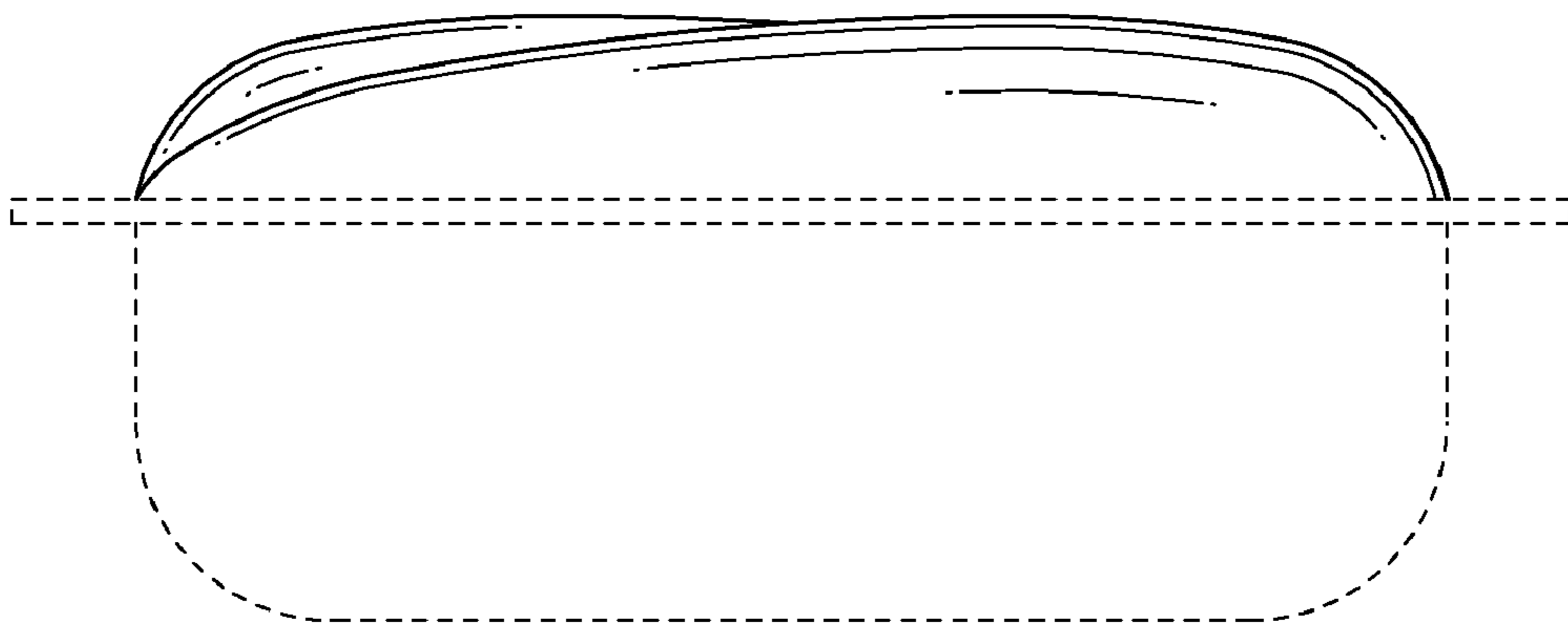

FIG. 20

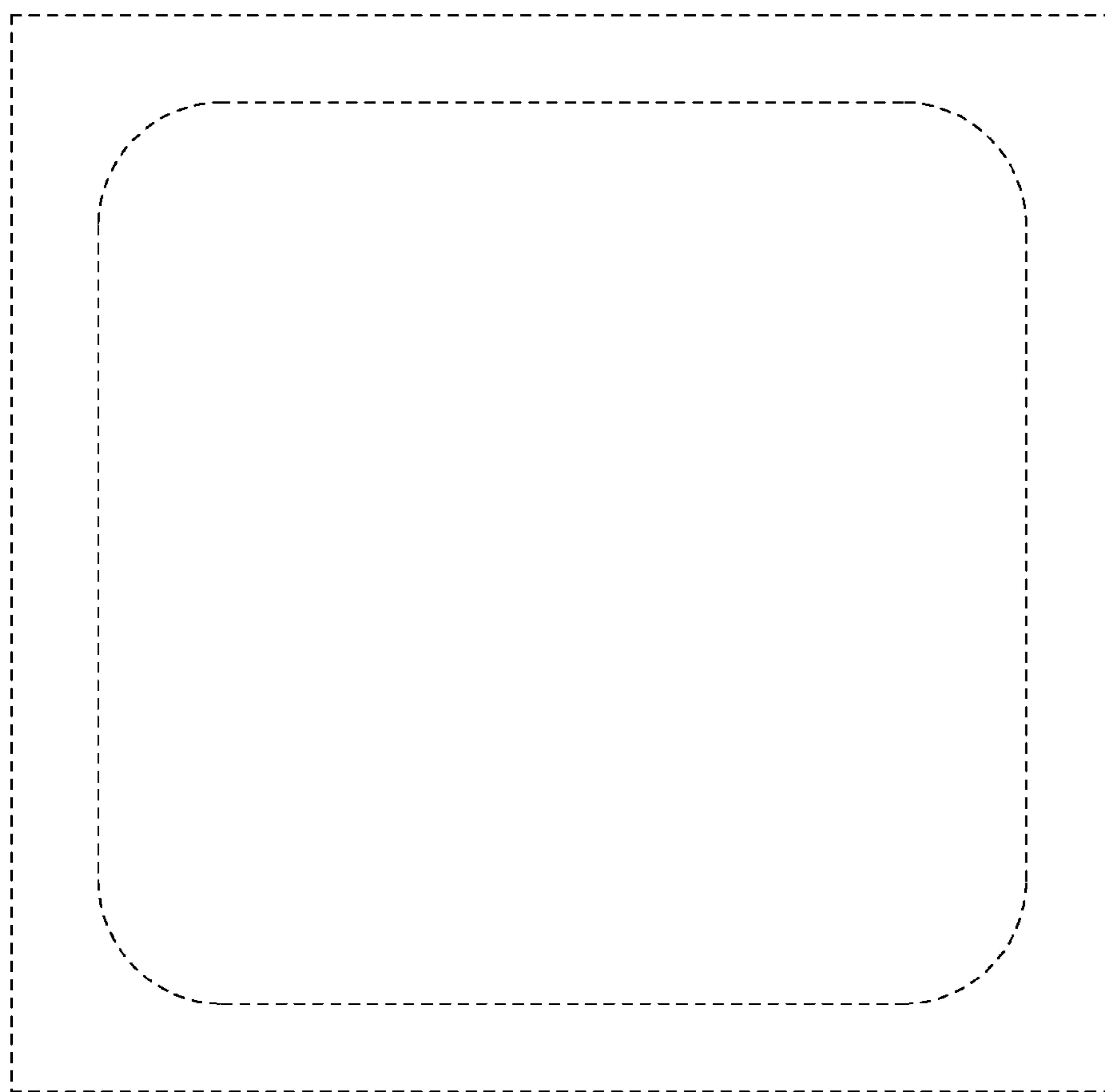

FIG. 21

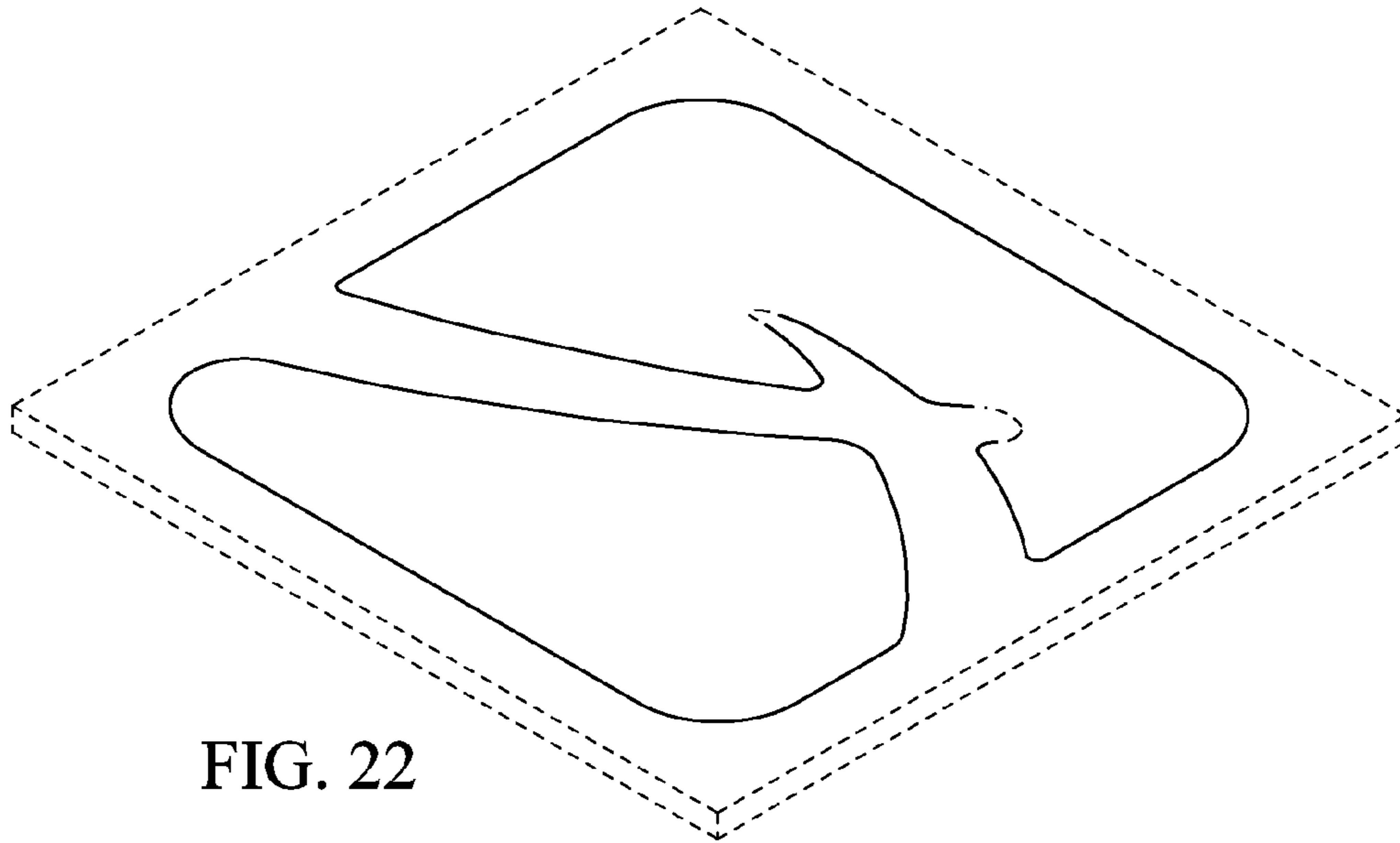

FIG. 22

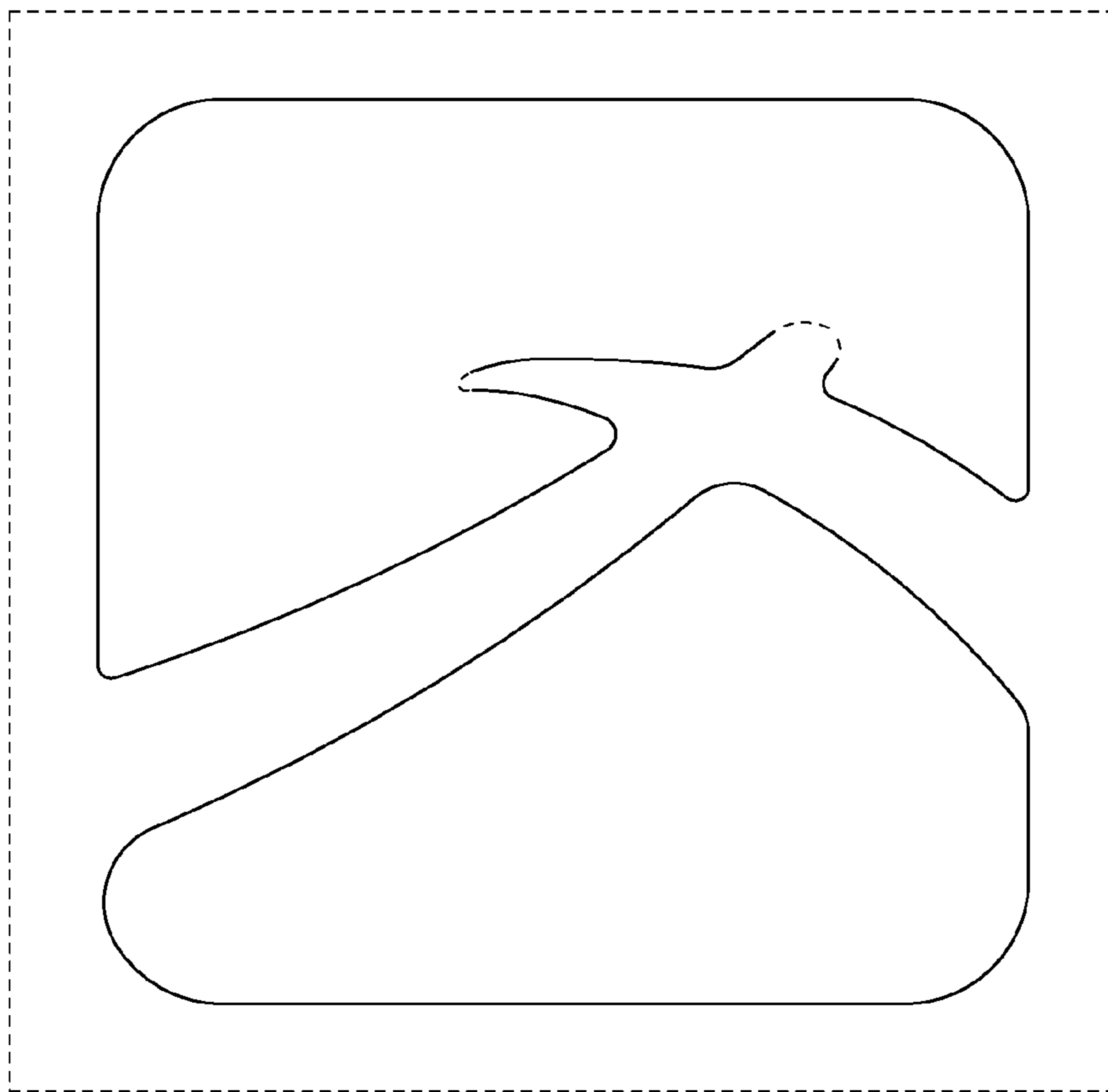

FIG. 23

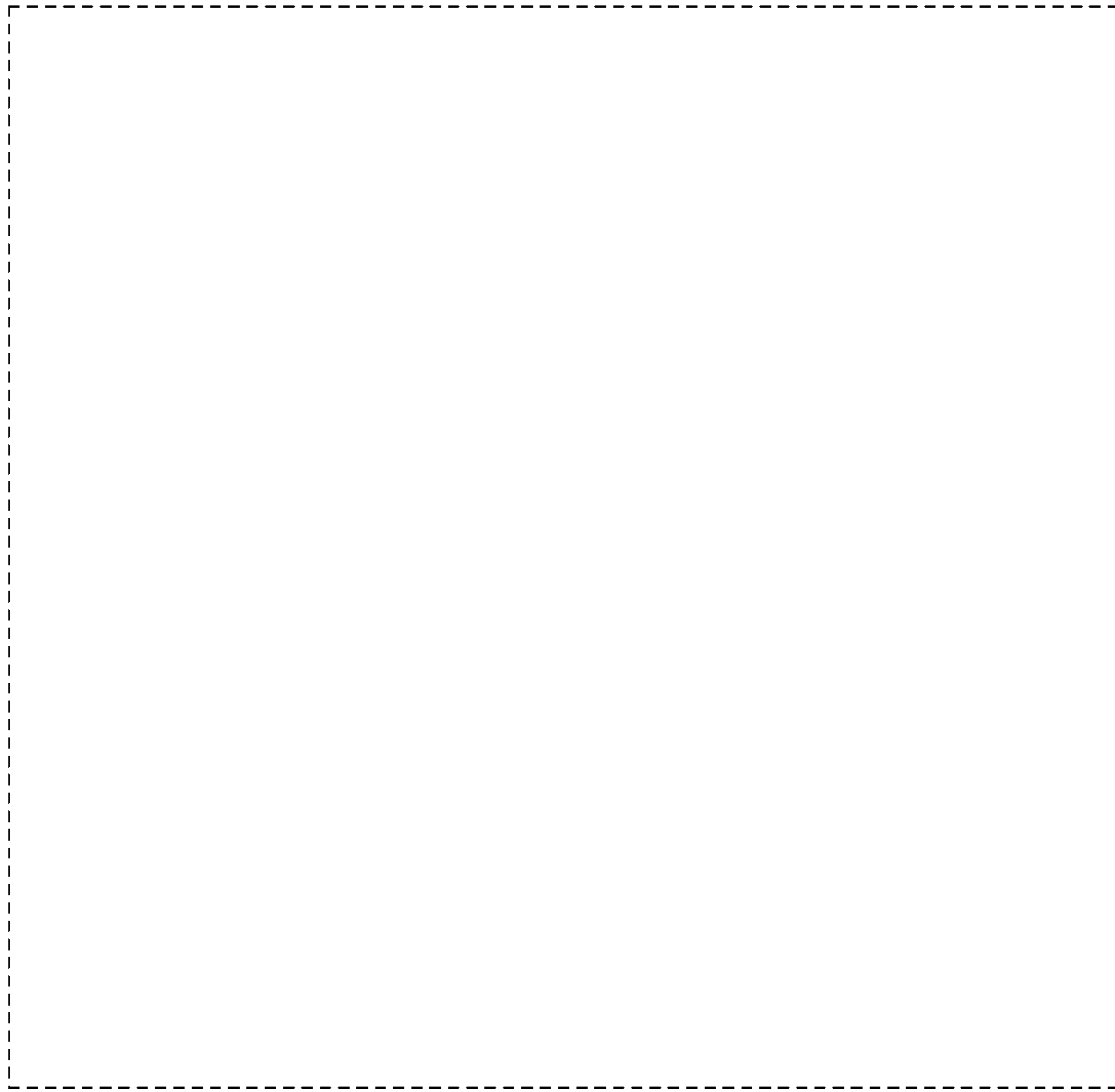

FIG. 24

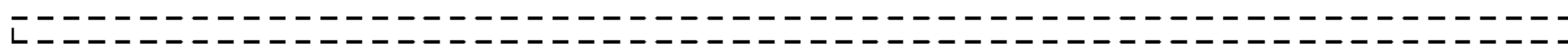

FIG. 25

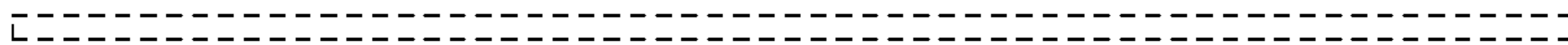

FIG. 26

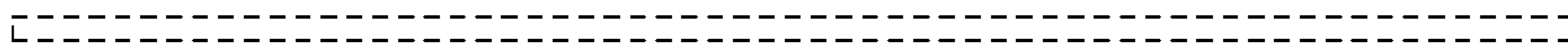

FIG. 27

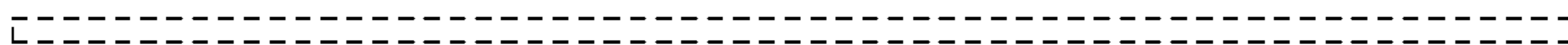

FIG. 28