

US00D599041S

(12) **United States Design Patent**
Yoo

(10) **Patent No.:** **US D599,041 S**

(45) **Date of Patent:** **** Aug. 25, 2009**

(54) **LED LAMP**

D582,578 S * 12/2008 Tsai et al. D26/2

(75) Inventor: **Young Ho Yoo**, Bucheon-si (KR)

* cited by examiner

(73) Assignee: **Fawoo Technology Co., Ltd.**,
Bucheon-Si, Gyeonggi-Do (KR)

Primary Examiner—Marcus A. Jackson

(74) *Attorney, Agent, or Firm*—Lee, Hong, Degerman, Kang
& Waimey

(**) Term: **14 Years**

(57) **CLAIM**

(21) Appl. No.: **29/328,327**

The ornamental design for an LED lamp, as shown and described.

(22) Filed: **Nov. 21, 2008**

(30) **Foreign Application Priority Data**

DESCRIPTION

May 30, 2008 (KR) 30-2008-0023041

FIG. 1 is a perspective view of an LED lamp;

(51) **LOC (9) Cl.** **26-04**

FIG. 2 is a front view thereof;

(52) **U.S. Cl.** **D26/2**

FIG. 3 is a rear view thereof;

(58) **Field of Classification Search** D26/1-4;
313/313, 315, 316, 317, 318, 493; 315/52,
315/53, 56, 57, 58

FIG. 4 is a left side view thereof;

FIG. 5 is a right side view thereof;

See application file for complete search history.

FIG. 6 is a plain view thereof;

FIG. 7 is a bottom view thereof;

(56) **References Cited**

FIG. 8 is a bottom perspective view thereof, exemplified for an electric bulb type lamp outlet; and,

U.S. PATENT DOCUMENTS

FIG. 9 is an exemplary view of an LED lamp for a halogen lamp outlet.

D560,286 S * 1/2008 Maxik et al. D26/2

D566,300 S * 4/2008 Lo D26/2

D570,504 S * 6/2008 Maxik et al. D26/2

1 Claim, 9 Drawing Sheets

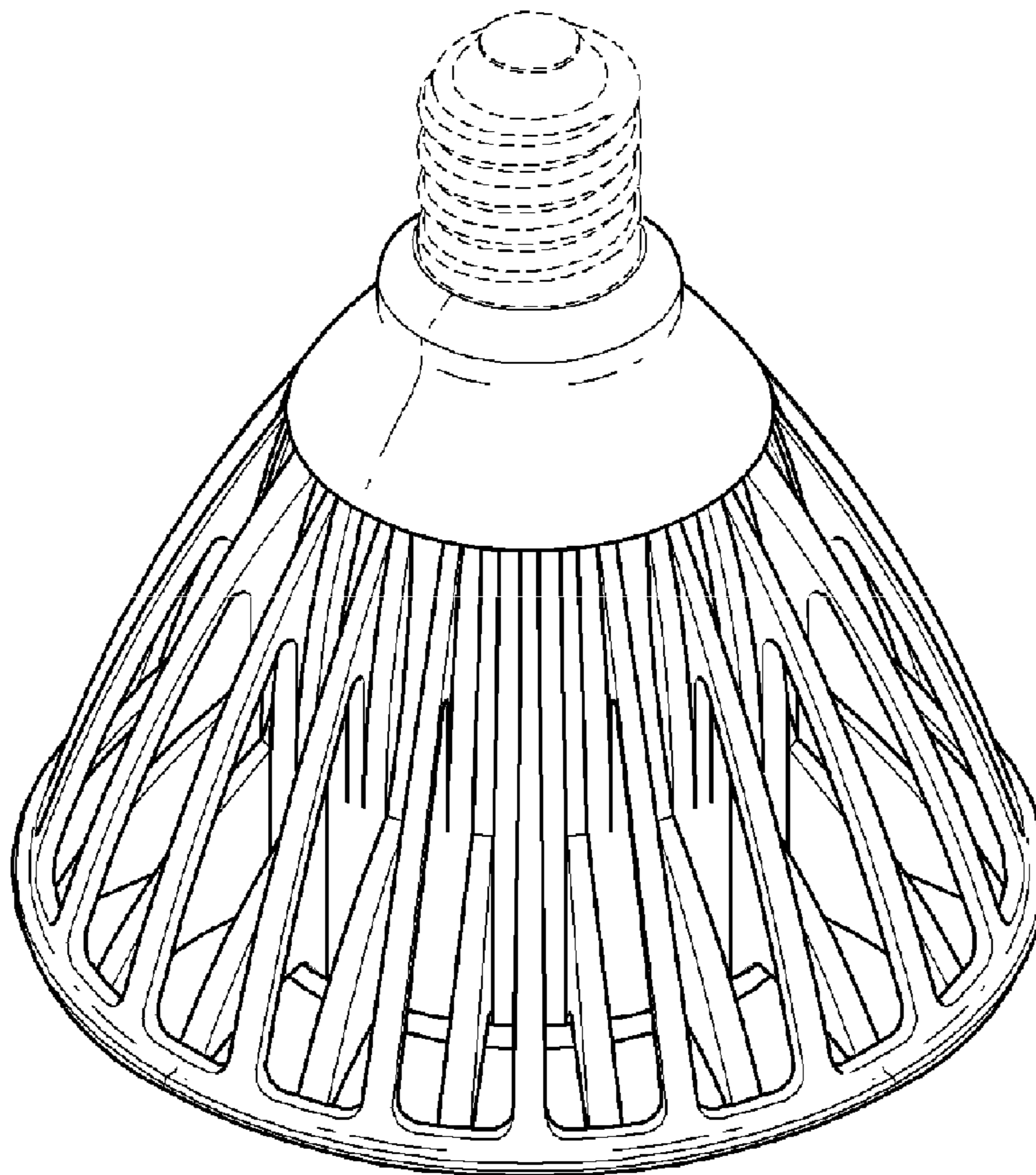

FIG. 1

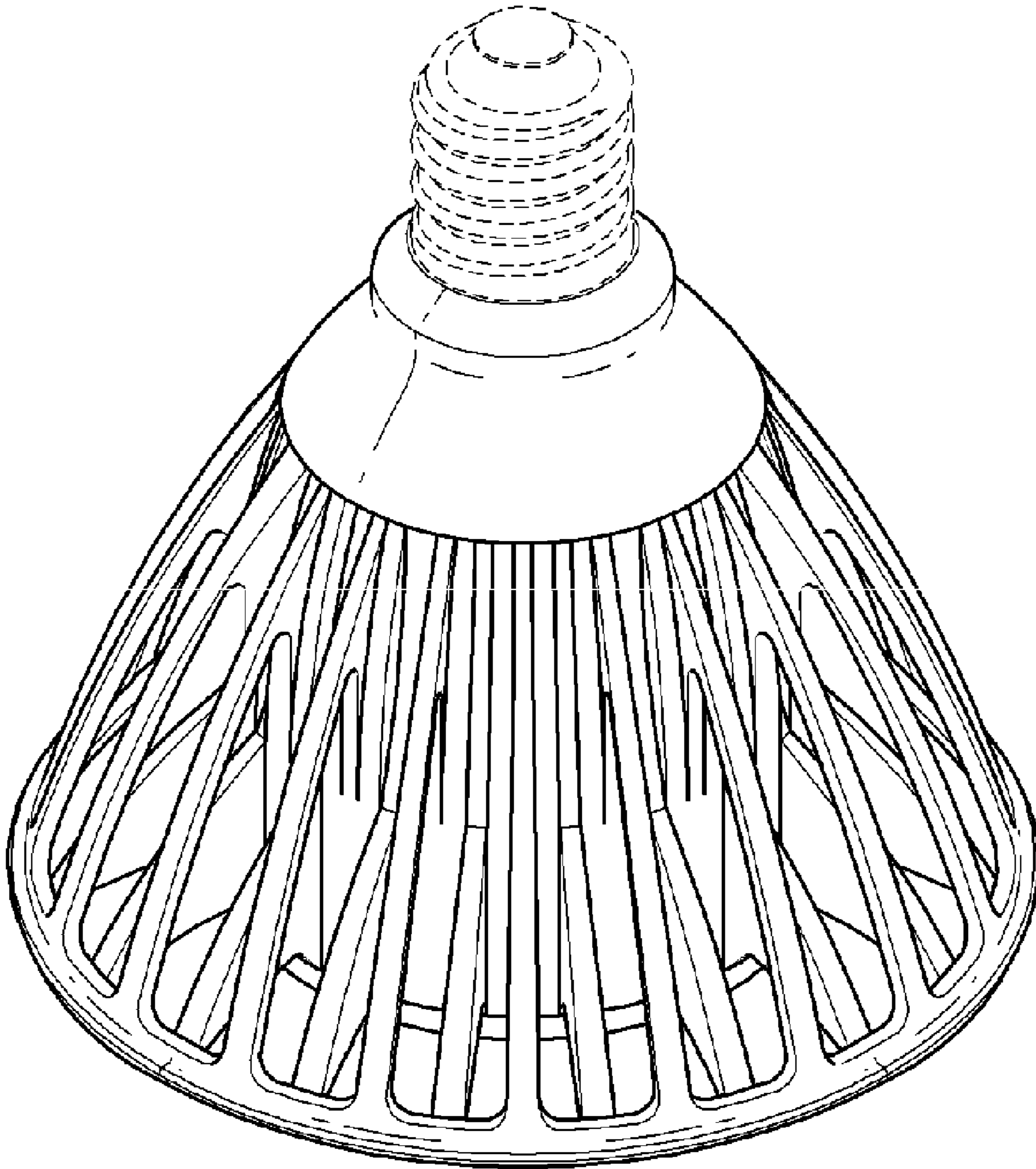

FIG. 2

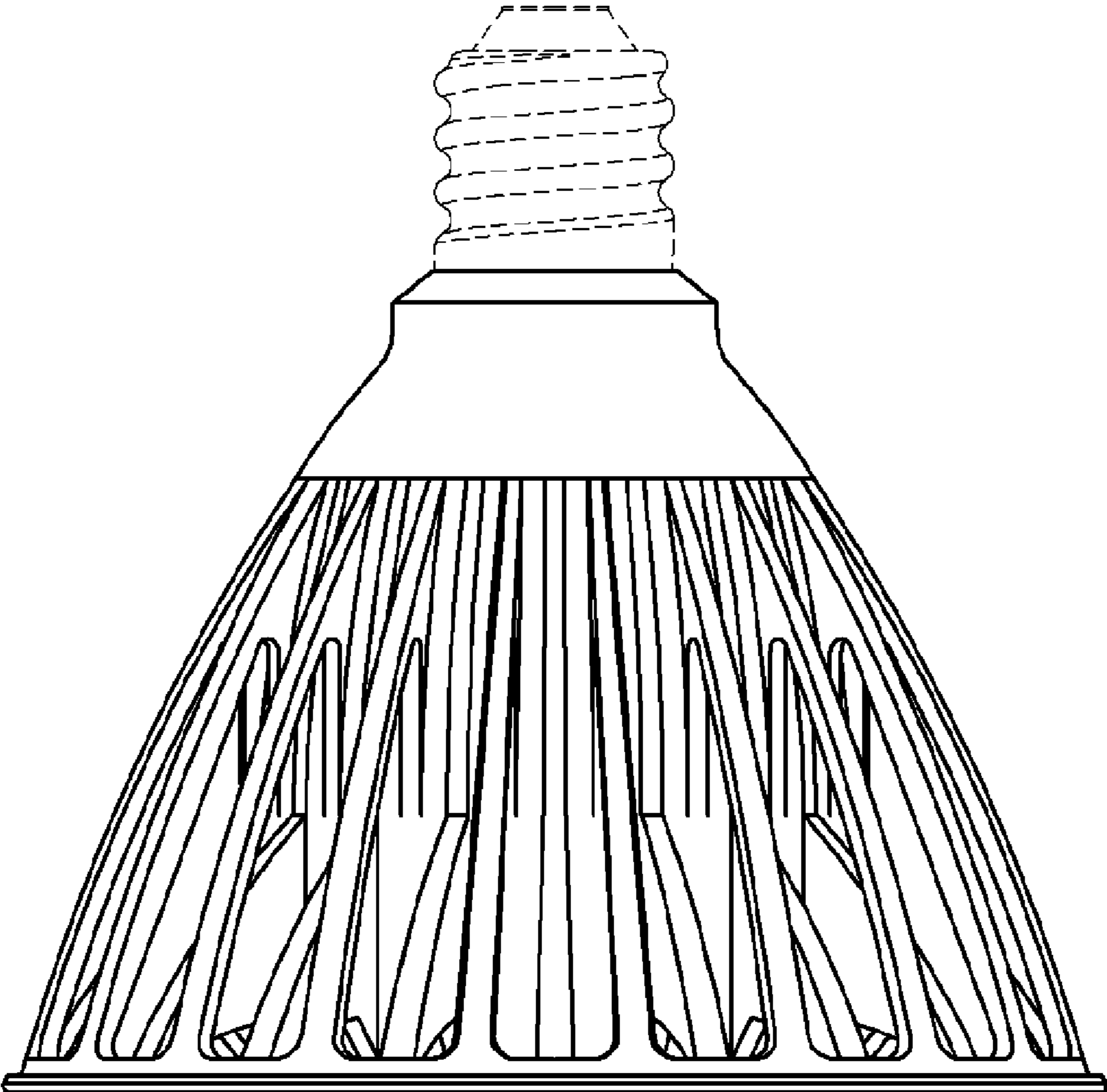

FIG. 3

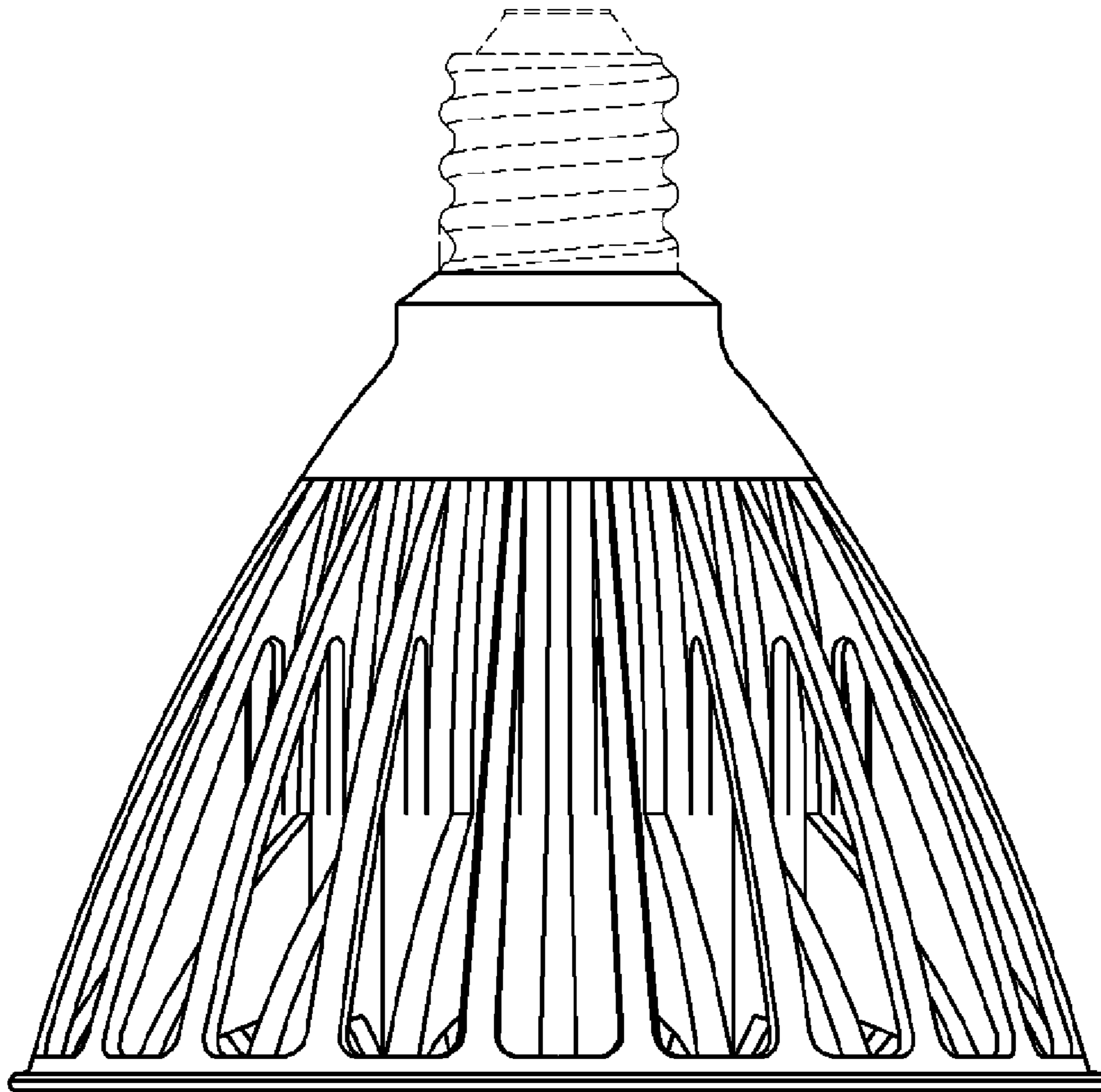

FIG. 4

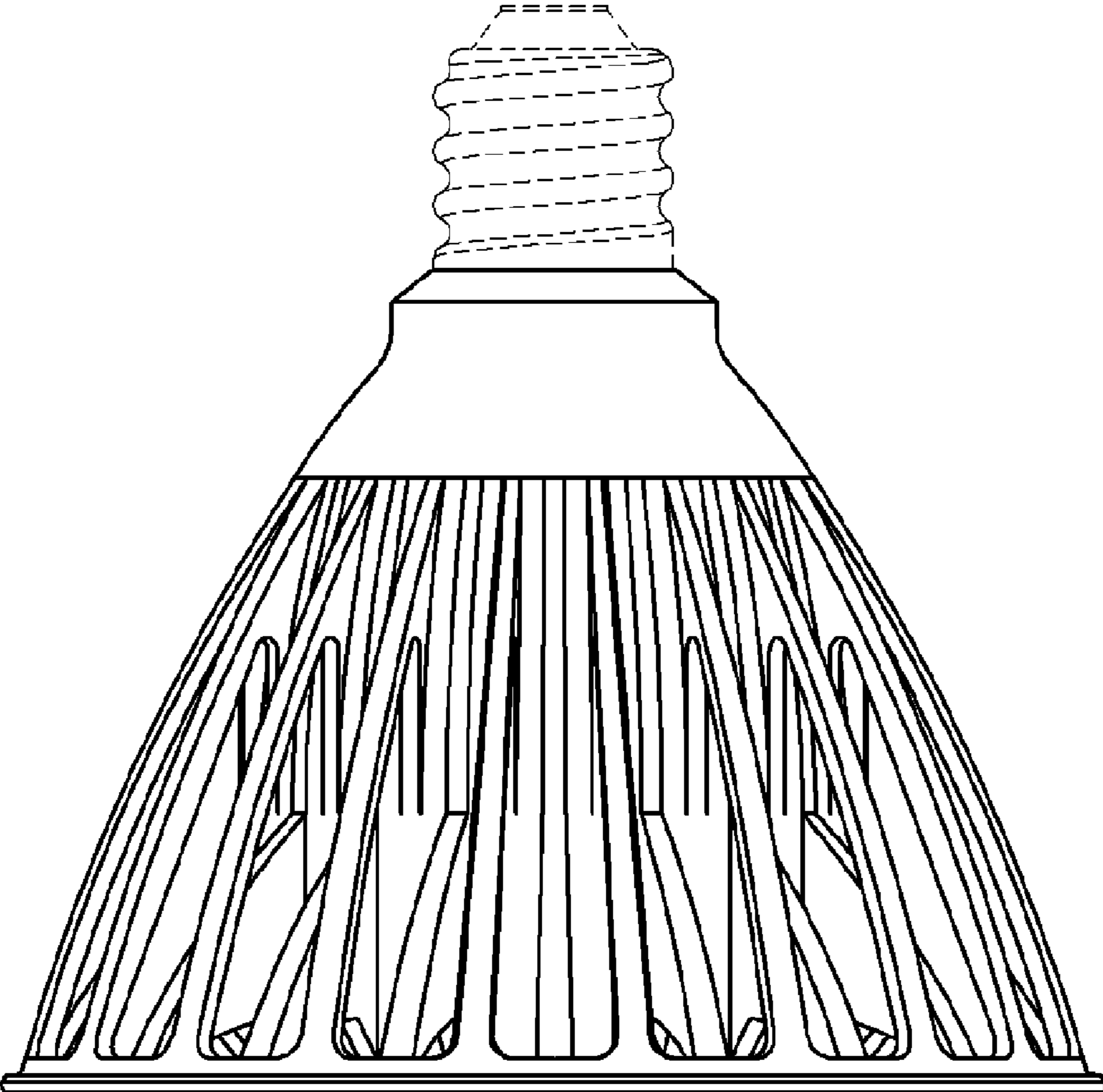

FIG. 5

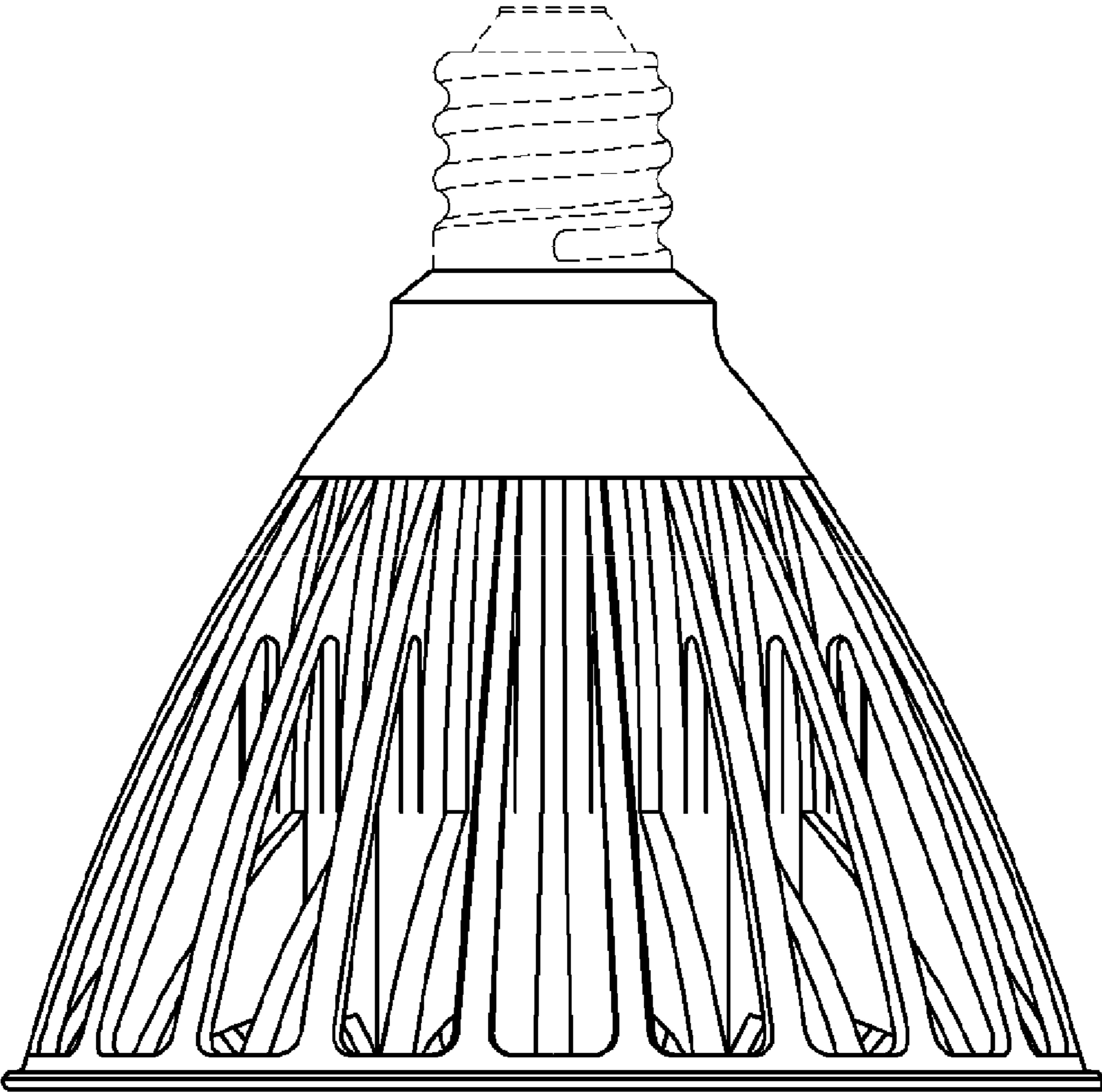

FIG. 6

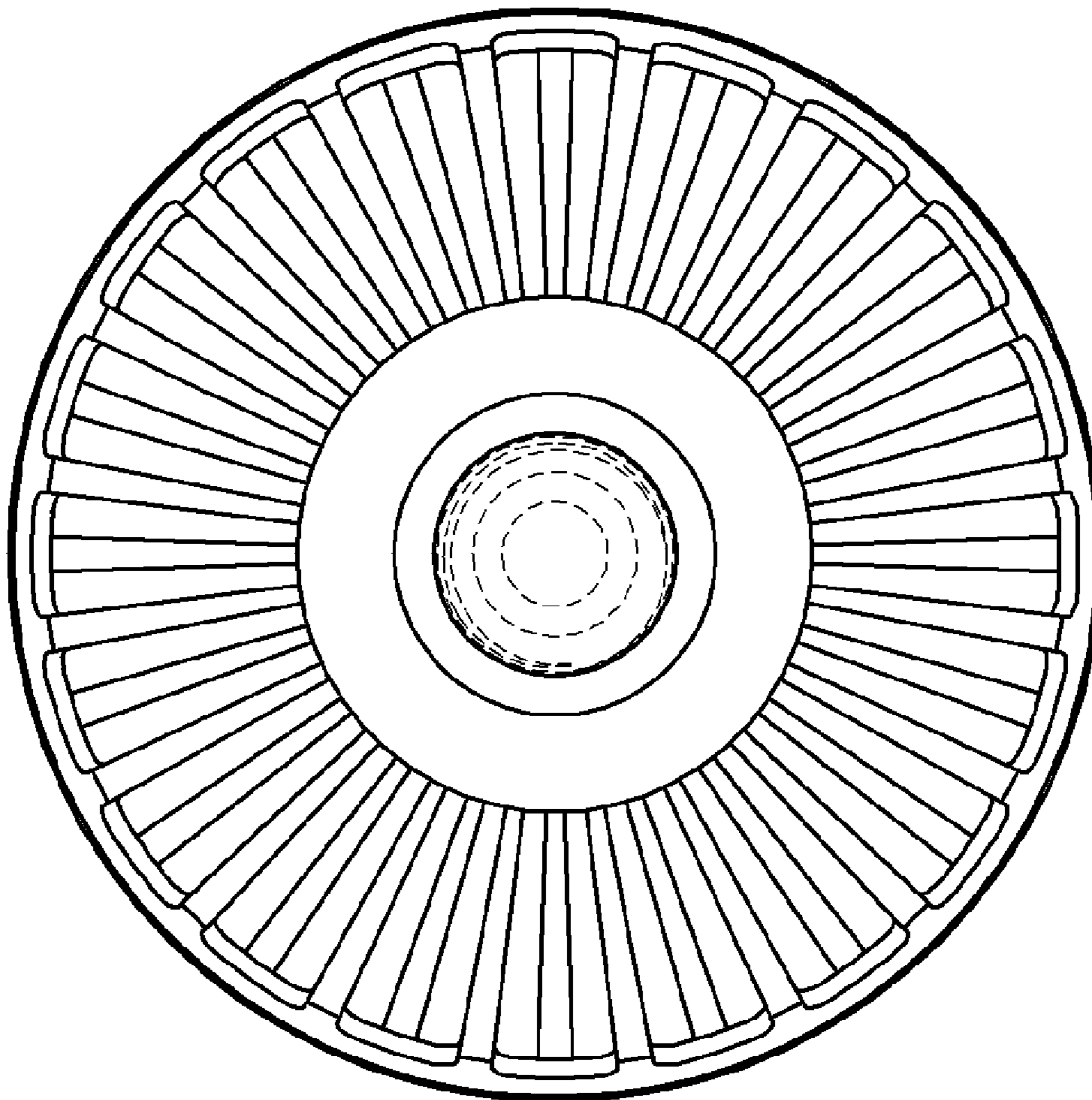

FIG. 7

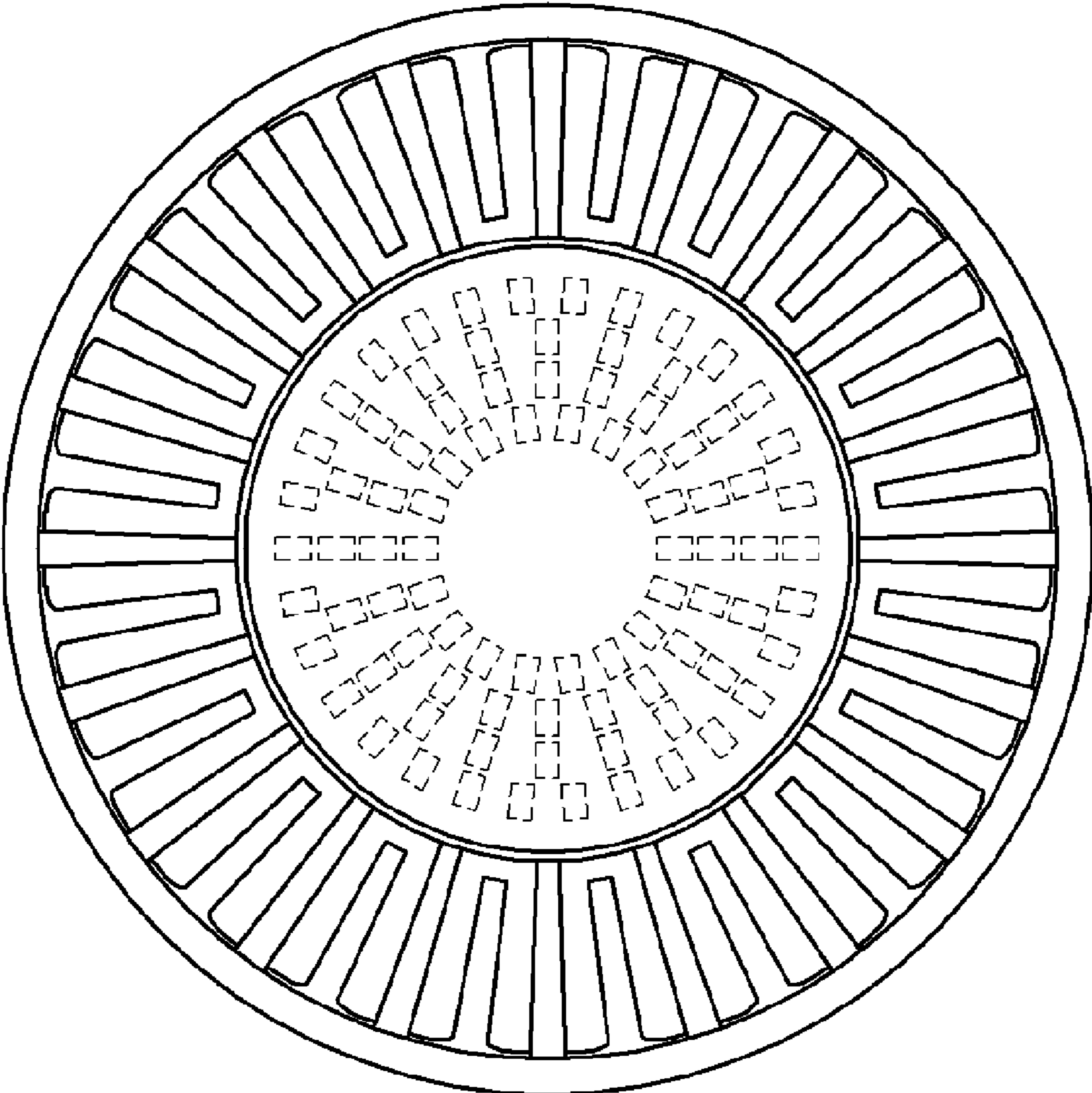

FIG. 8

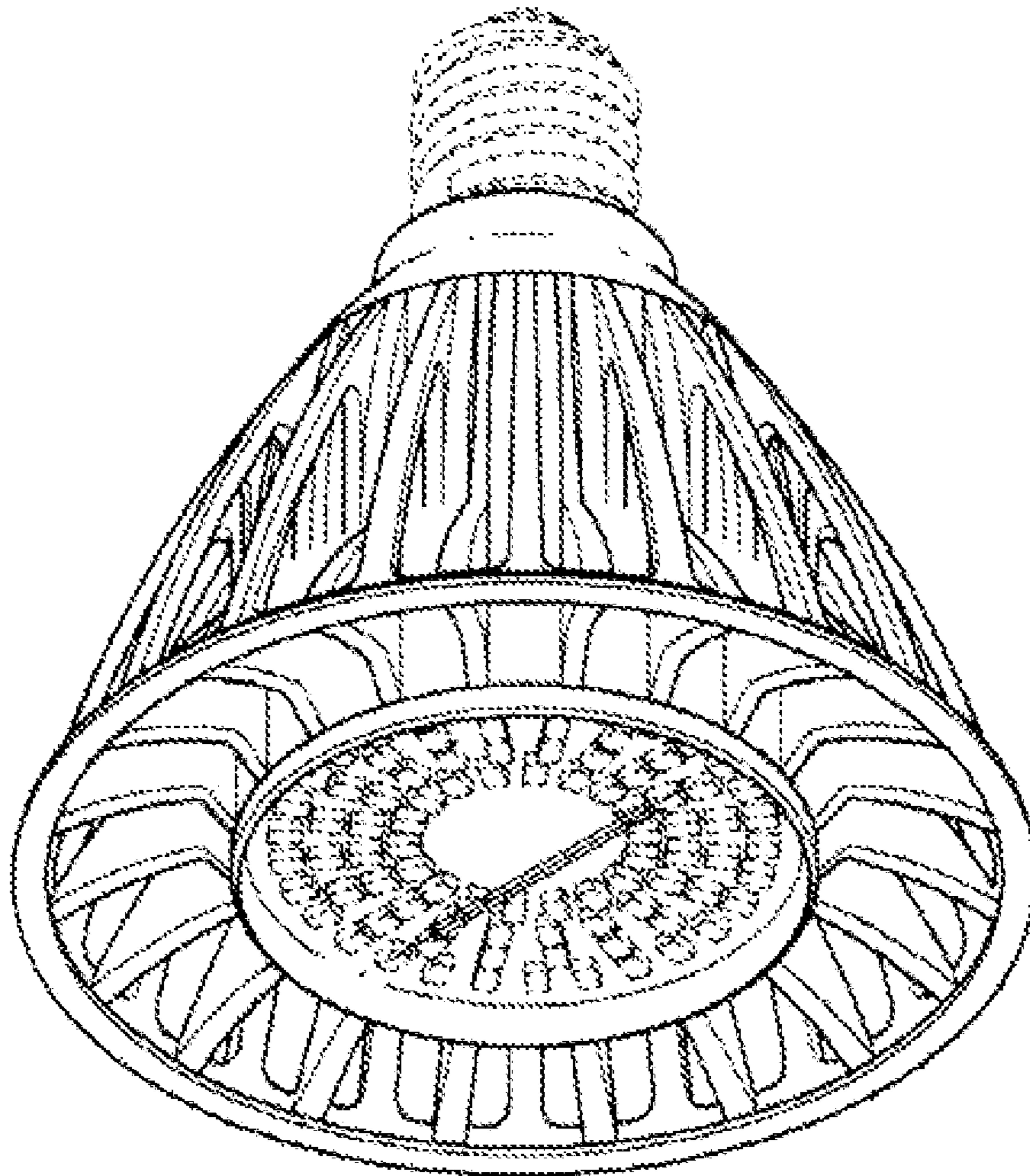

FIG. 9

