



US00D598805S

(12) **United States Design Patent**
Hardy

(10) **Patent No.:** **US D598,805 S**

(45) **Date of Patent:** **** Aug. 25, 2009**

(54) **CHAIN LINK**

(75) Inventor: **Pierre Hardy**, Paris (FR)

(73) Assignee: **Hermes Sellier (Societe Par Actions Simpliffee)**, Paris (FR)

(**) Term: **14 Years**

(21) Appl. No.: **29/324,994**

(22) Filed: **Sep. 24, 2008**

(30) **Foreign Application Priority Data**

Mar. 25, 2008 (WO) DM/069 970

(51) **LOC (9) Cl.** **11-01**

(52) **U.S. Cl.** **D11/93**

(58) **Field of Classification Search** D11/89-93,
D11/13, 15, 18, 1, 2, 4, 6-12, 16, 24-28,
D11/34-43, 79, 70, 222, 47, 75, 202, 38;
63/1.11-14.1, 15-15.4, 20, 22, 23, 26-33,
63/38; 24/116 R, 116 A; 59/84, 78, 79.3,
59/80, 92, 90; D24/194; D30/160; D8/499
See application file for complete search history.

(56) **References Cited**

U.S. PATENT DOCUMENTS

2,103,972 A * 12/1937 Harris 59/84
2,421,789 A * 6/1947 Ingham 59/3
2,525,193 A * 10/1950 Anderson et al. 59/84
2,753,680 A * 7/1956 Linnenbank 59/84
3,453,823 A * 7/1969 Mundt 59/90
3,557,737 A * 1/1971 Smulders 24/116 R

3,664,121 A * 5/1972 Camitz 59/84
3,864,906 A * 2/1975 Cullen 59/84
4,216,070 A * 8/1980 Debost 59/84
4,498,284 A * 2/1985 Gearhart 59/84
D519,191 S * 4/2006 Beall D11/13
D558,634 S * 1/2008 Hardy D11/13
D565,989 S * 4/2008 Ribeiro D1/13

* cited by examiner

Primary Examiner—T. Chase Nelson

Assistant Examiner—David G Muller

(74) *Attorney, Agent, or Firm*—Foley & Lardner LLP

(57) **CLAIM**

The ornamental design for a chain link, as shown and described.

DESCRIPTION

FIG. 1 is a front view of a chain link according to my new design;

FIG. 2 is a back view of the chain link shown in FIG. 1;

FIG. 3 is a left side view of the chain link shown in FIG. 1;

FIG. 4 is a right side view of the chain link shown in FIG. 1;

FIG. 5 is a top view of the chain link shown in FIG. 1;

FIG. 6 is a bottom view of the chain link shown in FIG. 1; and,

FIG. 7 is a top frontal perspective view of the chain link shown in FIG. 1.

The broken lines depict portions of the chain link that form no part of the claimed design.

1 Claim, 3 Drawing Sheets

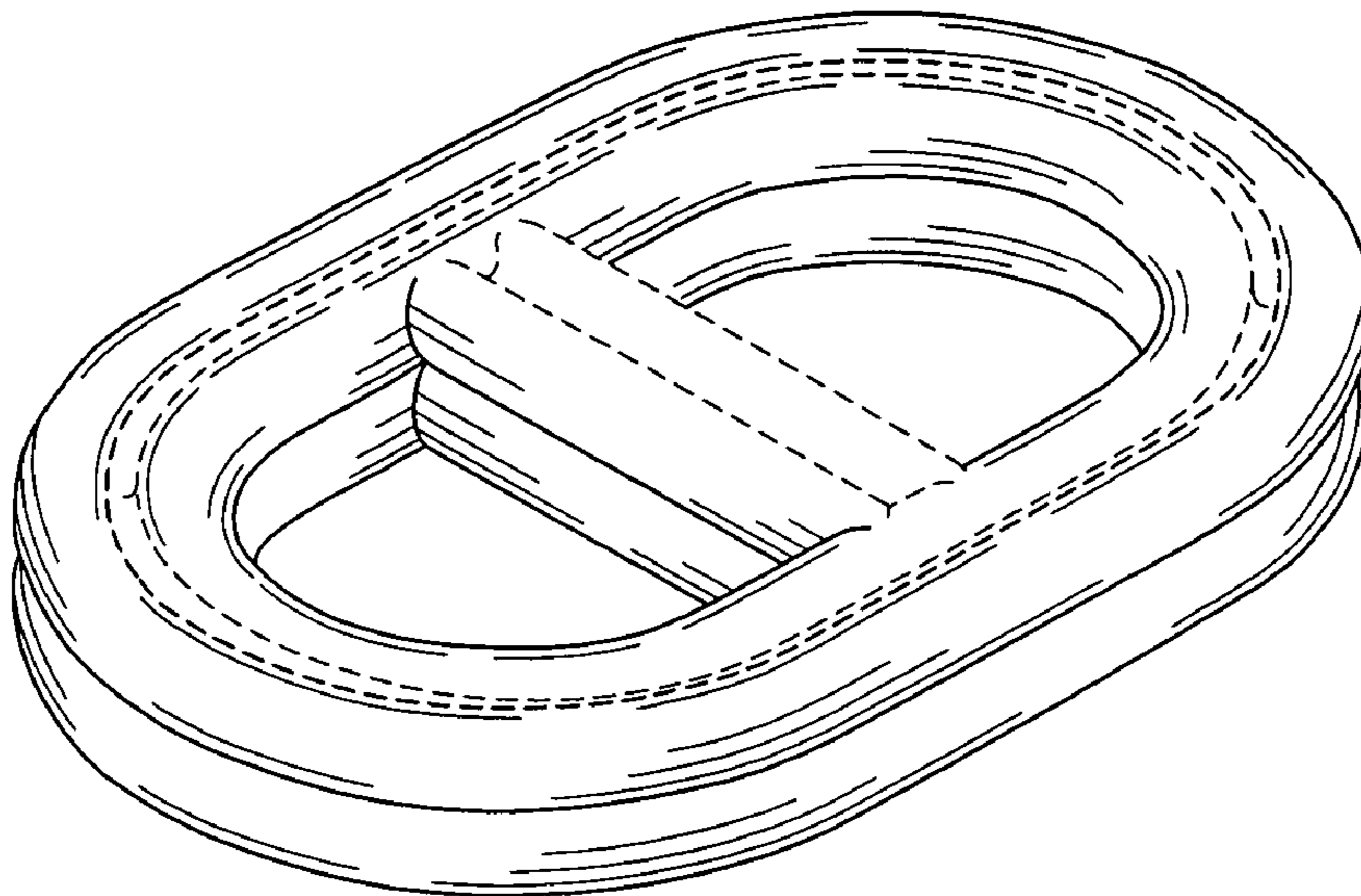

Fig. 1

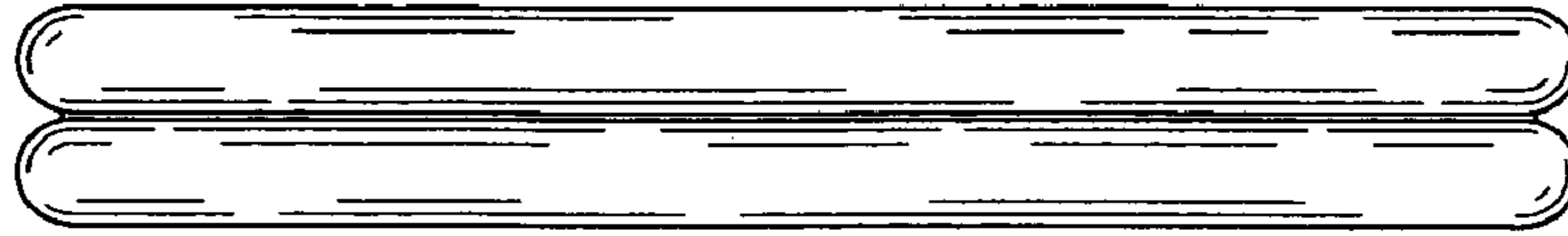

Fig. 2

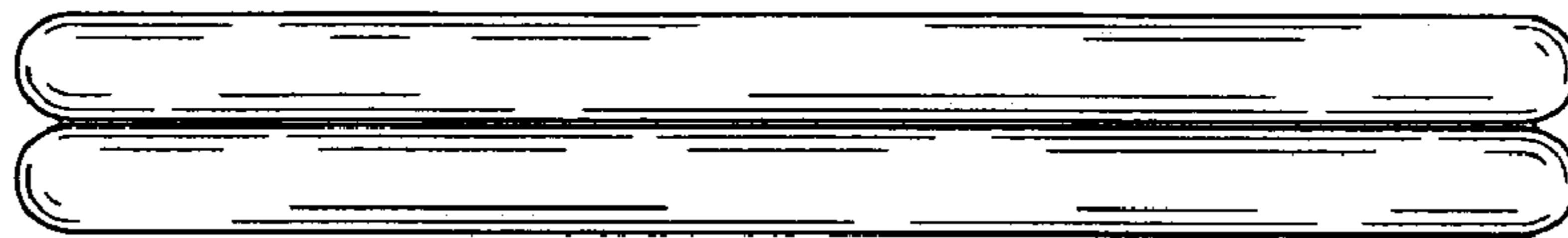

Fig. 3

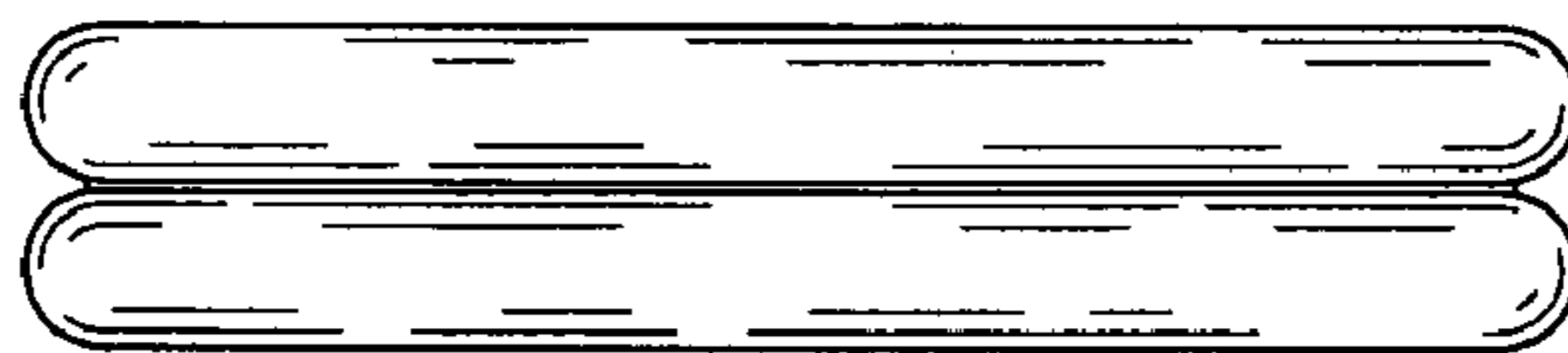

Fig. 4

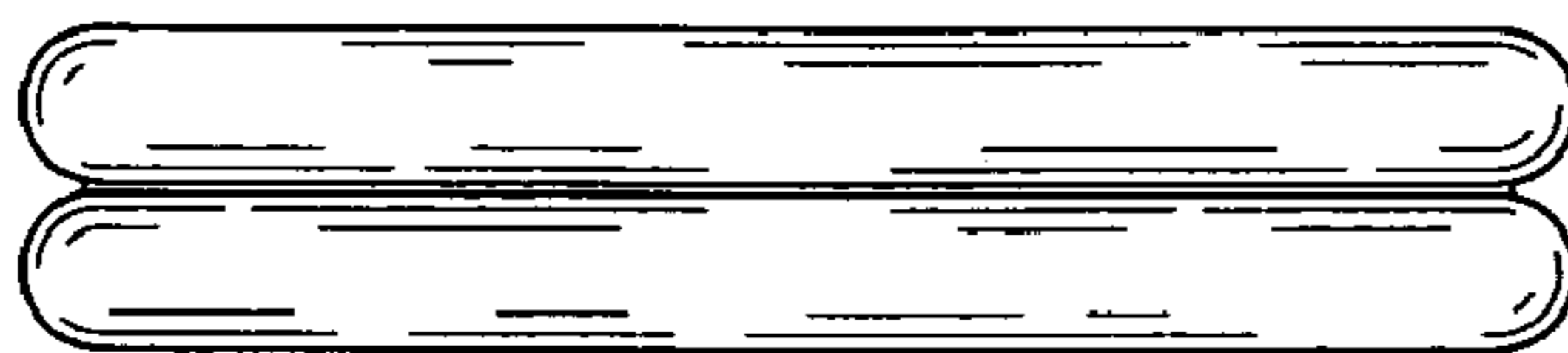

Fig. 5

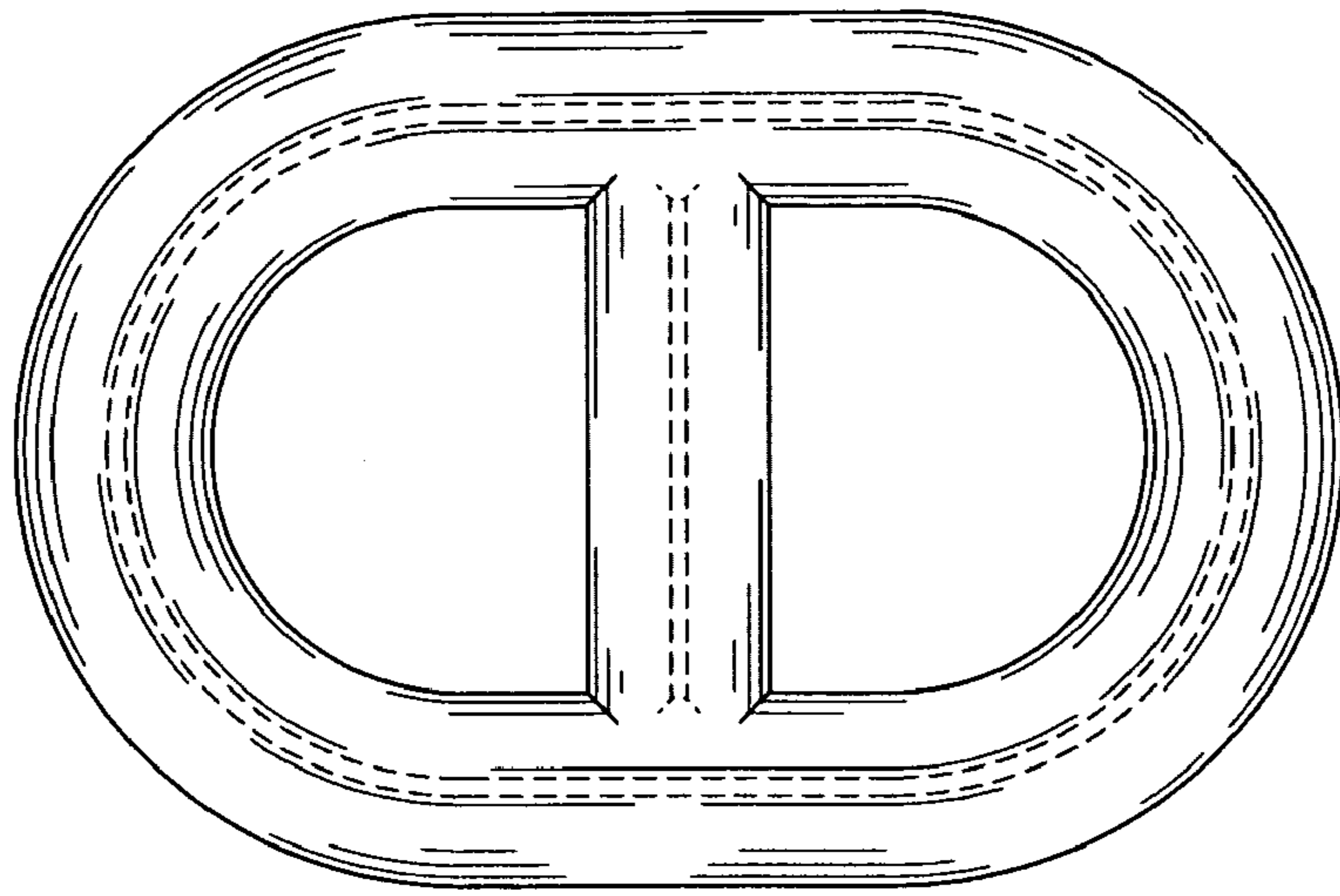

Fig. 6

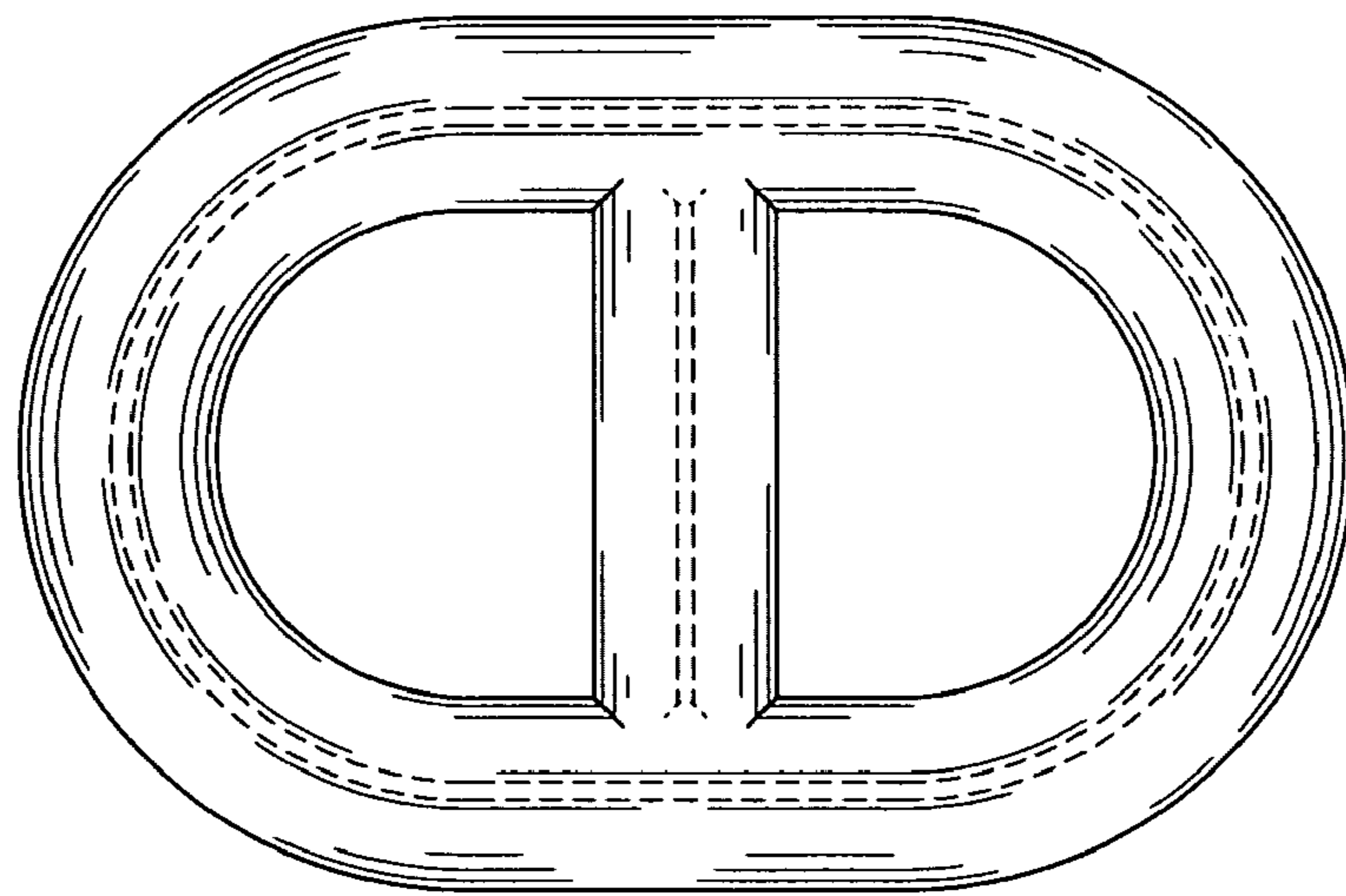

Fig. 7

