



US00D598654S

(12) **United States Design Patent**  
**Huang**

(10) **Patent No.:** **US D598,654 S**

(45) **Date of Patent:** **\*\* Aug. 25, 2009**

(54) **TOOTHBRUSH**

(75) Inventor: **Shou-Jen Huang**, Sanchung (TW)

(73) Assignee: **Acumen Co., Ltd.**, Sanchung, Taipei Hsien (TW)

(\*\*) Term: **14 Years**

(21) Appl. No.: **29/332,584**

(22) Filed: **Feb. 20, 2009**

(51) **LOC (9) Cl.** ..... **04-02**

(52) **U.S. Cl.** ..... **D4/108**

(58) **Field of Classification Search** ..... D4/104-112,  
D4/134, 138; 15/110, 143.1, 167.1, 167.2;  
132/308-311; 601/139, 141; 606/161  
See application file for complete search history.

(56) **References Cited**

**U.S. PATENT DOCUMENTS**

2006/0010628 A1\* 1/2006 Moskovich ..... 15/111  
2006/0064833 A1\* 3/2006 Jacobs ..... 15/110  
2007/0283518 A1\* 12/2007 Blanchard et al. .... 15/167.1  
2008/0131834 A1\* 6/2008 Shepherd et al. .... 433/29

**FOREIGN PATENT DOCUMENTS**

KR 30-0436408 S \* 1/2007

**OTHER PUBLICATIONS**

EM 65677-0003 Industrial Design Application, (M + C Shiffer GmbH) Jan. 27, 2004, [online], [retrieved on Apr. 18, 2008]

Retrieved from the OAMI Database of the Office for Harmonization in the Internal Market using the Internet <URL: <http://oami.europa.eu>>.\*

HK 0800531.4 Industrial Design Application, (Colgate-Palmolive Company) Apr. 25, 2008, [online], [retrieved on May 24, 2009] Retrieved from the Designs Registry, Intellectual Property Department of the Government of Hong Kong Special Administrative Region using the Internet <URL: <http://ipsearch.ipd.gov.hk>>.\*

\* cited by examiner

*Primary Examiner*—Melanie H Tung

*Assistant Examiner*—Lavone D Tabor

(74) *Attorney, Agent, or Firm*—patenttm.us

(57) **CLAIM**

The ornamental design for a toothbrush, as shown.

**DESCRIPTION**

FIG. 1 is a perspective view of a toothbrush showing my new design;

FIG. 2 is a front view thereof;

FIG. 3 is an enlarged left view thereof;

FIG. 4 is an enlarged right view thereof;

FIG. 5 is a top view thereof;

FIG. 6 is a bottom view thereof; and,

FIG. 7 is another perspective view thereof.

**1 Claim, 5 Drawing Sheets**

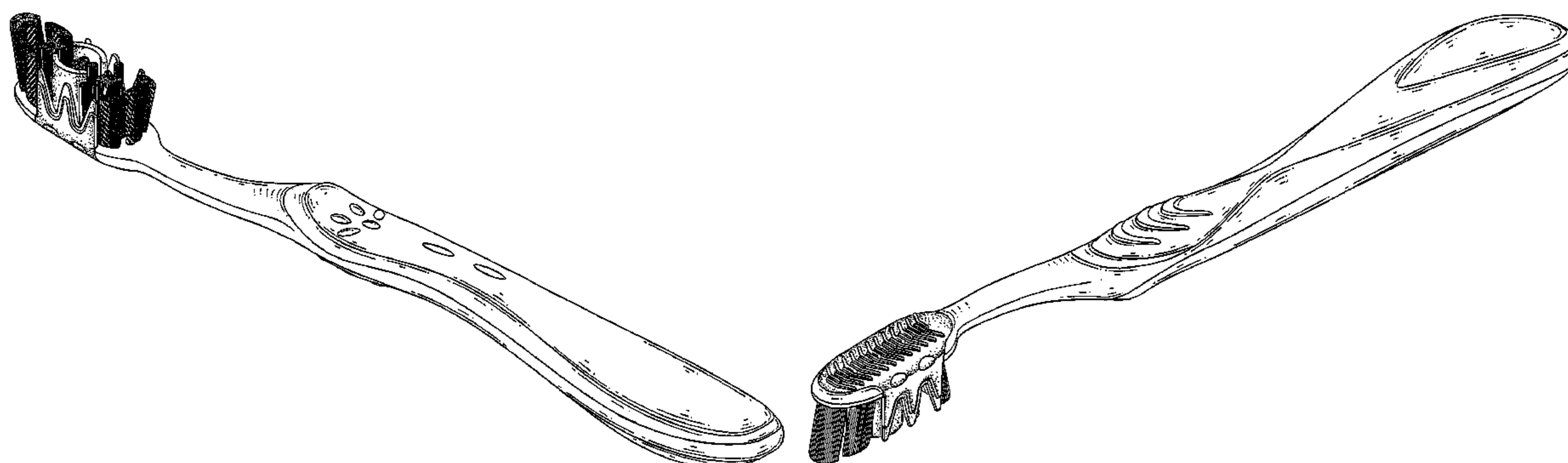

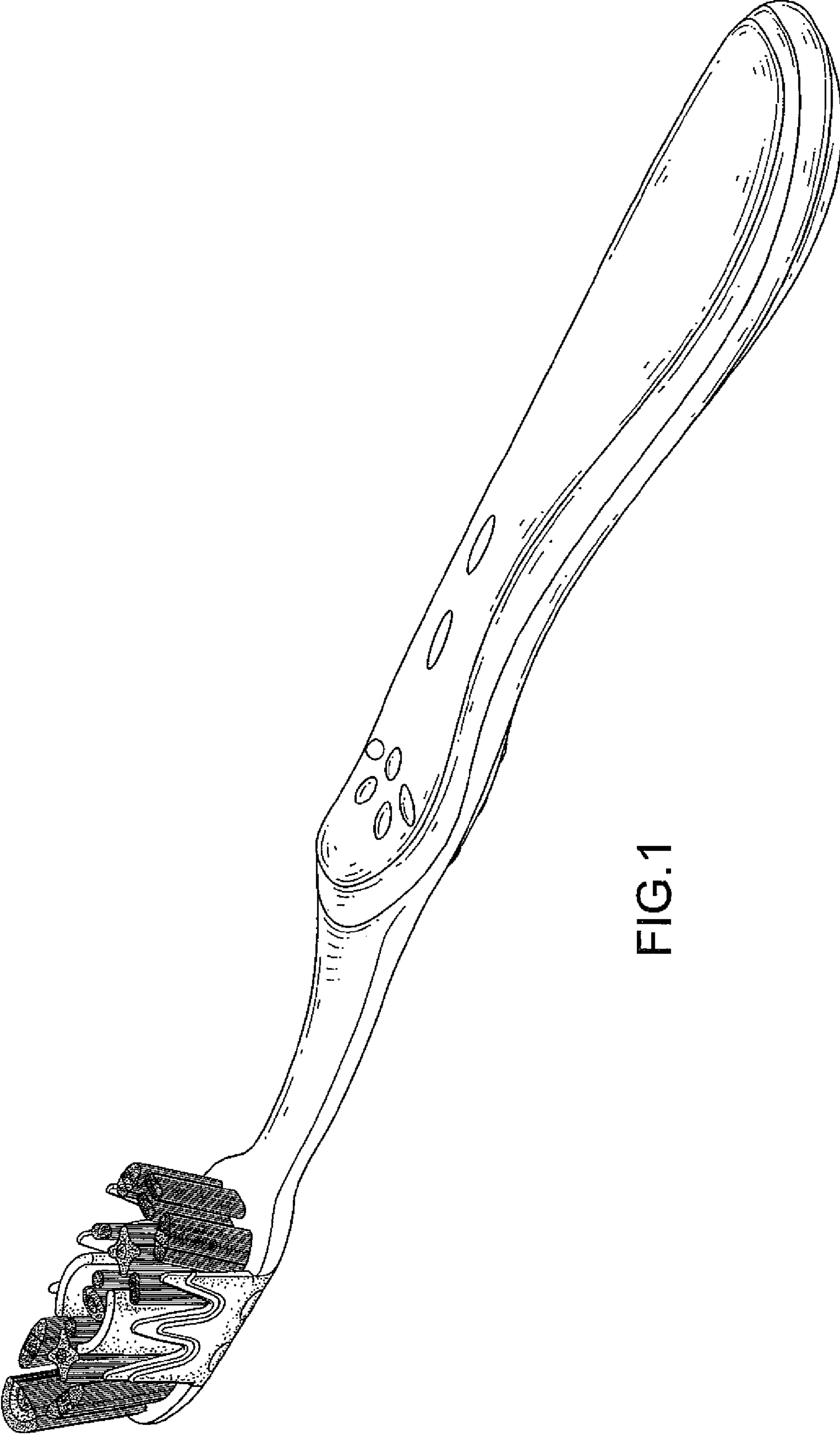

FIG.1

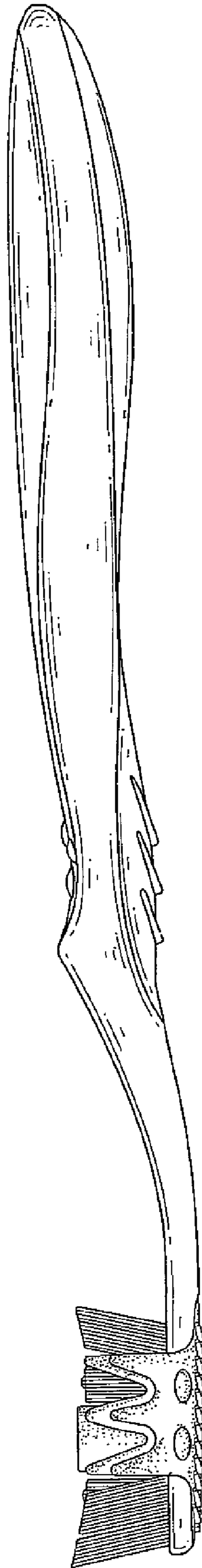

FIG. 2

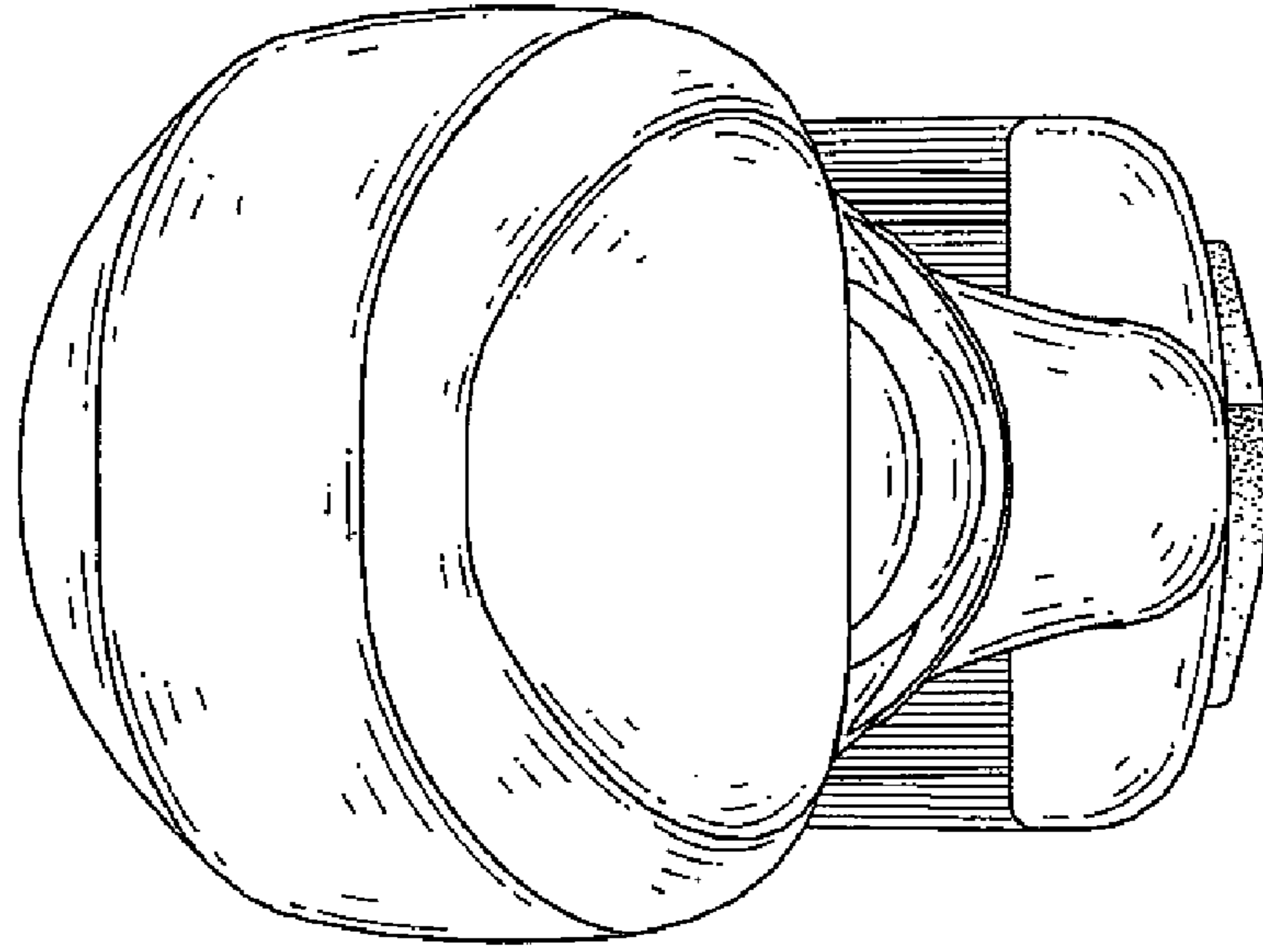

FIG. 4

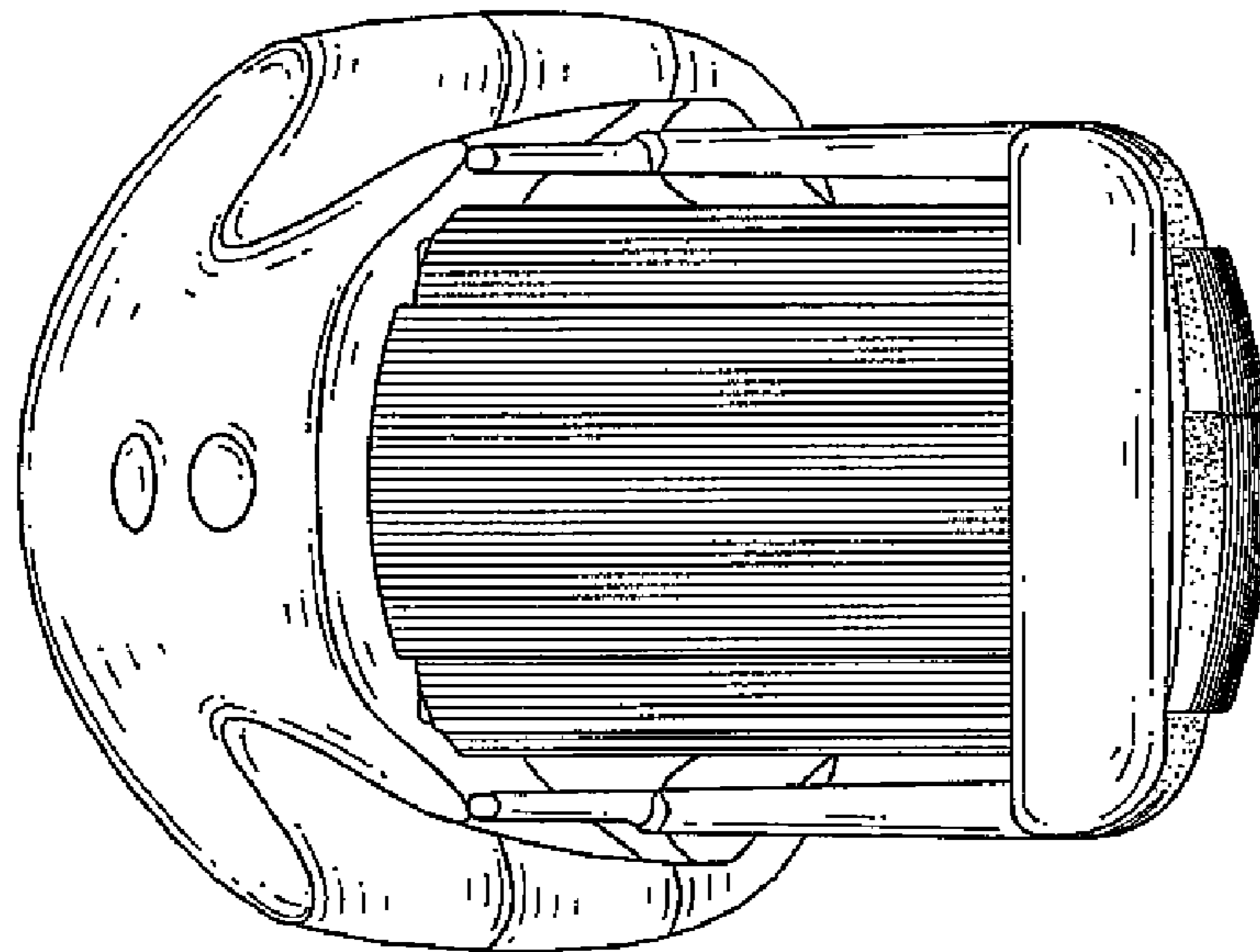

FIG. 3

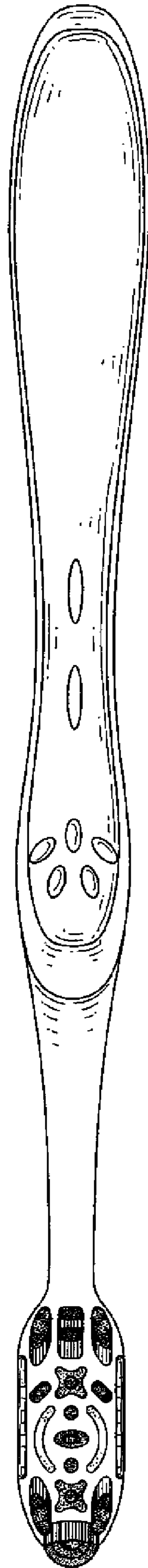

FIG. 5

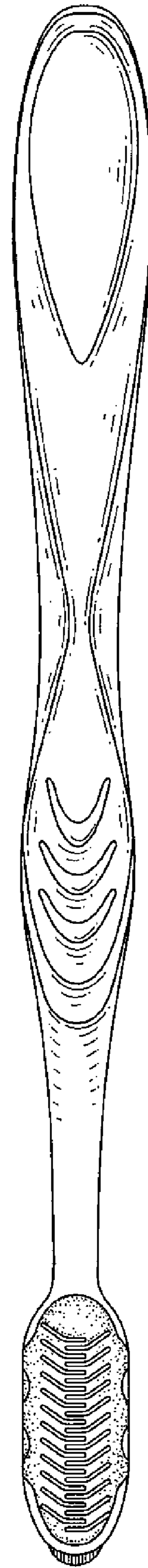

FIG. 6

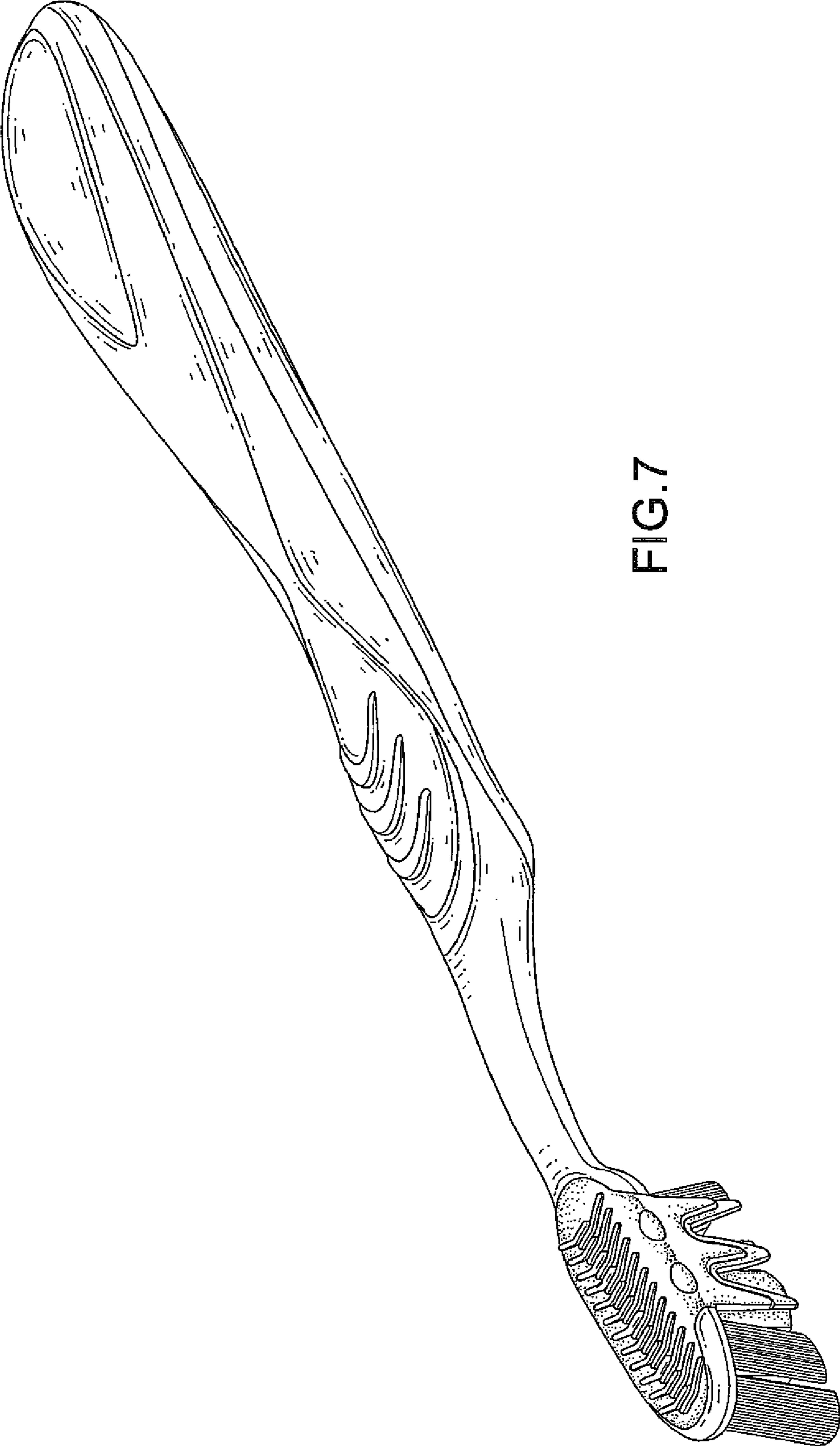

FIG.7