



US00D598556S

(12) **United States Design Patent**  
**Chen**

(10) **Patent No.:** **US D598,556 S**

(45) **Date of Patent:** **\*\* Aug. 18, 2009**

(54) **HEATED BACK BRACE**

(76) **Inventor:** **Chien-Chou Chen**, 25, Lane 89,  
Yuguang Li, Anping District, Tainan City  
(TW)

(\*\*) **Term:** **14 Years**

(21) **Appl. No.:** **29/328,270**

(22) **Filed:** **Nov. 21, 2008**

(51) **LOC (9) Cl.** ..... **24-01**

(52) **U.S. Cl.** ..... **D24/190; D24/206**

(58) **Field of Classification Search** ..... D24/189-192,  
D24/206; D29/100, 101.3; D2/627, 702;  
602/1-2, 4-8, 19-20, 60-62, 65; 128/100.1,  
128/876, 892, 894; 2/24, 162, 455; 219/211,  
219/527, 544, 549

See application file for complete search history.

(56) **References Cited**

**U.S. PATENT DOCUMENTS**

D211,975	S	*	8/1968	Steinborn	.....	D2/627
3,687,143	A	*	8/1972	Schneeberger et al.	.....	602/2
D242,174	S	*	11/1976	Evans	.....	D24/190
D274,556	S	*	7/1984	Muller et al.	.....	D24/206
D278,657	S	*	4/1985	Nakao et al.	.....	D24/190
D336,566	S	*	6/1993	Desjardins	.....	D29/101.1
D338,533	S	*	8/1993	Burget et al.	.....	D24/206
D353,205	S	*	12/1994	Canavan	.....	D24/206
D375,186	S	*	11/1996	Kim	.....	D29/101.3
D393,904	S	*	4/1998	Miura	.....	D24/206
5,928,275	A	*	7/1999	Yates et al.	.....	607/112

D433,145	S	*	10/2000	Davis et al.	.....	D24/206
D451,605	S	*	12/2001	Snider	.....	D24/190
6,506,175	B1	*	1/2003	Goldstein	.....	602/60
D498,036	S	*	11/2004	Newman	.....	D2/627
D500,137	S	*	12/2004	Hely	.....	D24/190
D546,953	S	*	7/2007	Young	.....	D24/190
D550,847	S	*	9/2007	Kixmiller	.....	D24/190
D554,268	S	*	10/2007	Harding	.....	D24/190
D566,288	S	*	4/2008	Chuang	.....	D24/206

\* cited by examiner

*Primary Examiner*—T. Chase Nelson

*Assistant Examiner*—Susan E Krakower

(74) *Attorney, Agent, or Firm*—Alan Kamrath; Kamrath & Associates PA

(57) **CLAIM**

The ornamental design for a heated back brace, as shown and described.

**DESCRIPTION**

FIG. 1 is a perspective view of a heated back brace showing my design;

FIG. 2 is a front elevational view thereof;

FIG. 3 is a rear elevational view thereof;

FIG. 4 is a left side elevational view thereof;

FIG. 5 is a right side elevational view thereof;

FIG. 6 is a top plan view thereof; and,

FIG. 7 is a bottom plan view thereof.

**1 Claim, 4 Drawing Sheets**

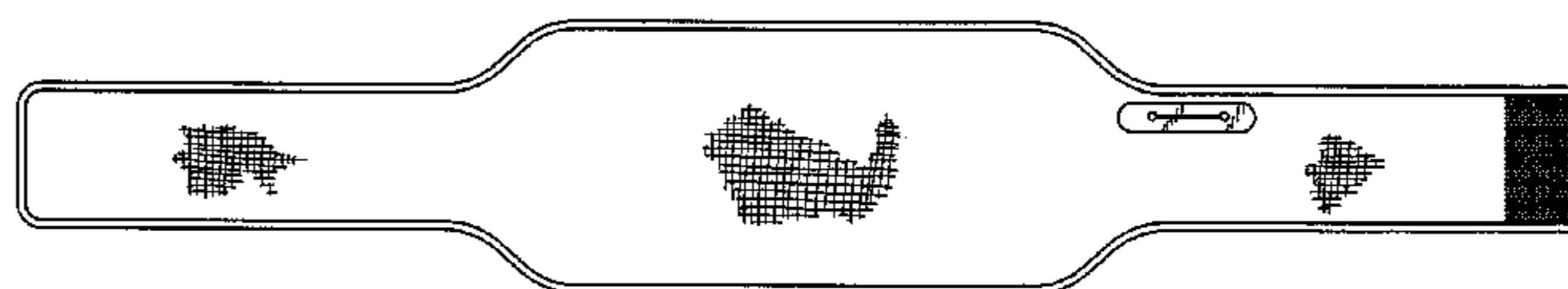
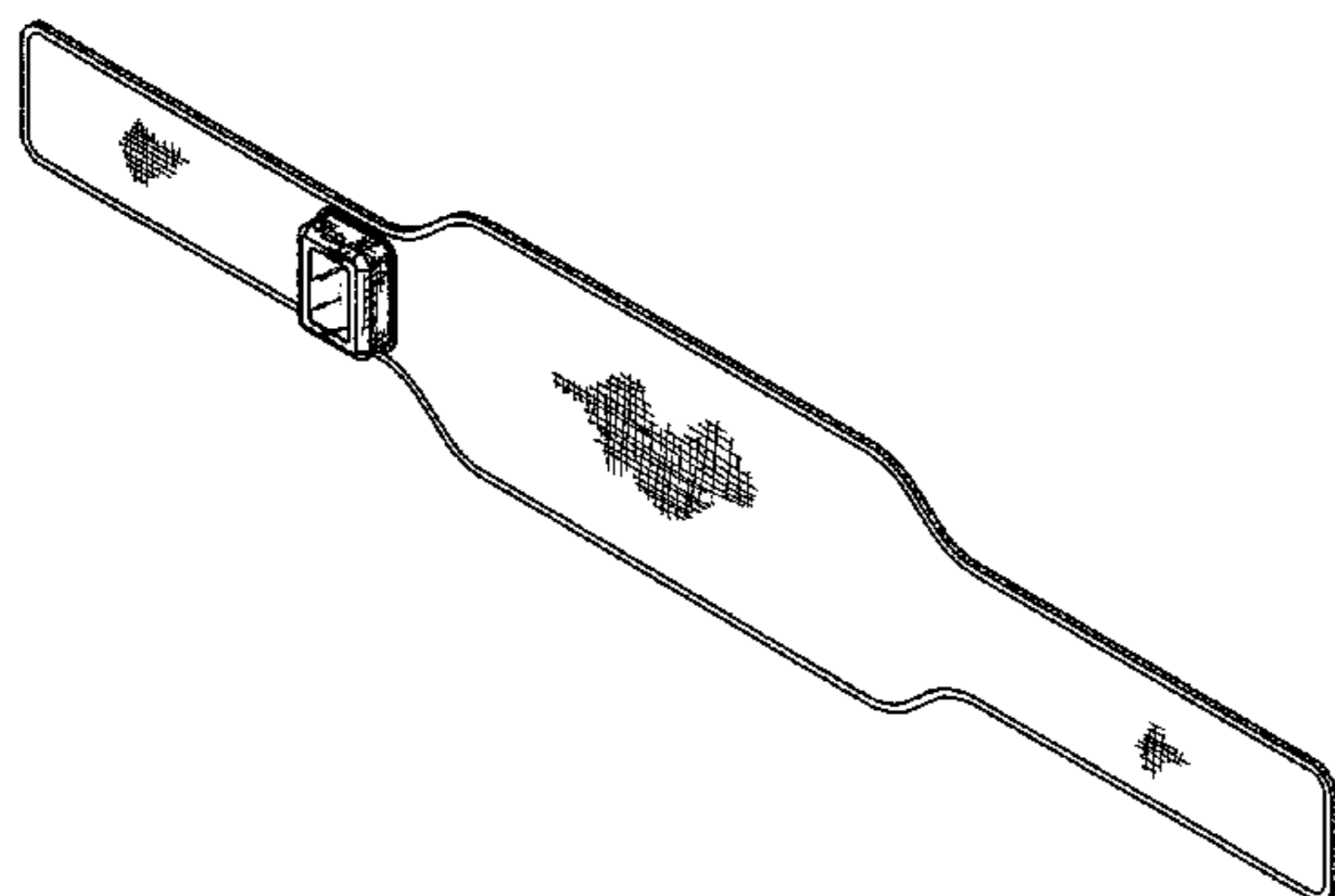

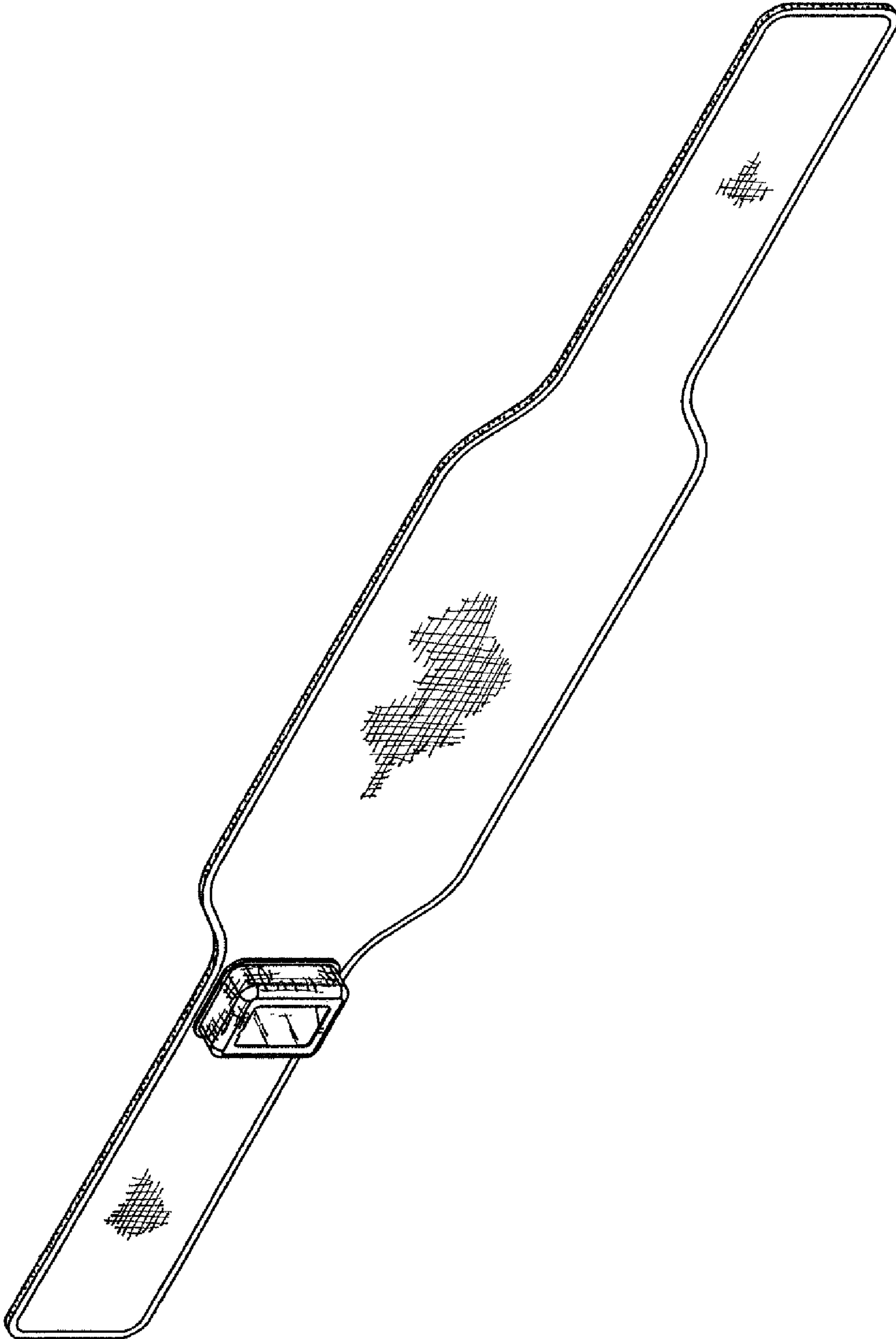

FIG. 1

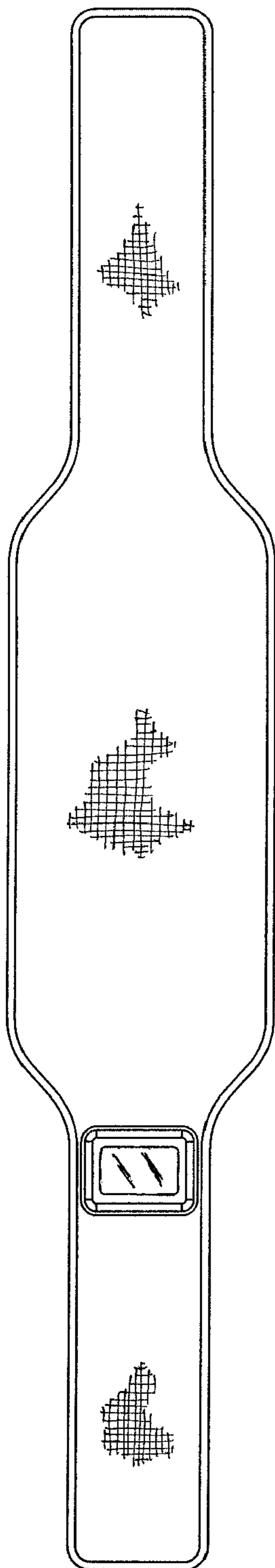

FIG. 2

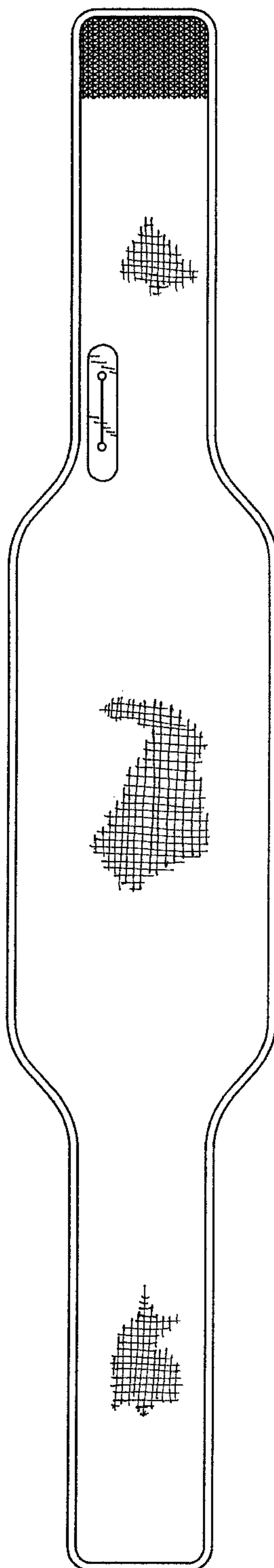

FIG. 3

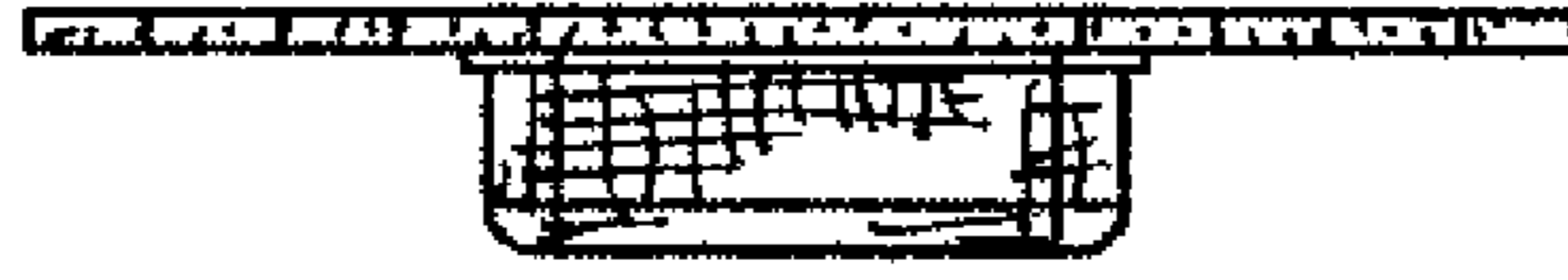

FIG. 4

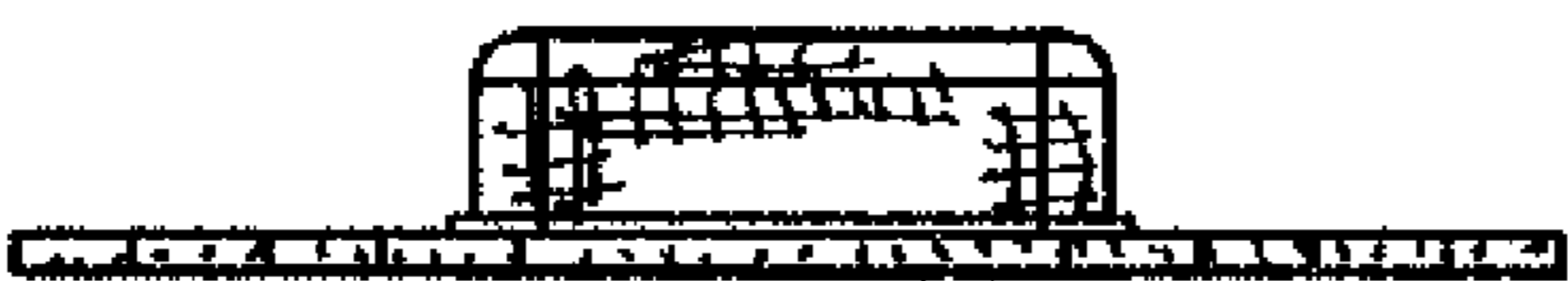

FIG. 5



FIG. 6



FIG. 7