



US00D598531S

(12) **United States Design Patent**  
**Irvin**

(10) **Patent No.:** **US D598,531 S**  
(45) **Date of Patent:** **\*\* Aug. 18, 2009**

(54) **SINGLE SCENT AIR FRESHENER**

(75) Inventor: **Aaron Irvin**, Salt Lake City, UT (US)  
(73) Assignee: **American Covers, Inc.**, Bluffdale, UT (US)  
(\*\*) Term: **14 Years**  
(21) Appl. No.: **29/331,515**  
(22) Filed: **Jan. 27, 2009**

(51) **LOC (9) Cl.** ..... **28-99**  
(52) **U.S. Cl.** ..... **D23/366**  
(58) **Field of Classification Search** ..... D23/355-369;  
261/DIG. 17, DIG. 42, DIG. 65, DIG. 88,  
261/DIG. 89; 239/34-37, 44, 45, 53, 54,  
239/57, 60, 136, 152, 302, 326; 392/386,  
392/390, 392, 394, 395; D28/5, 6  
See application file for complete search history.

(56) **References Cited**

**U.S. PATENT DOCUMENTS**

5,050,798	A	9/1991	Sullivan	
5,114,625	A	5/1992	Gibson	
5,234,162	A	8/1993	Sullivan	
D432,222	S *	10/2000	Rymer et al.	D23/366
6,325,475	B1	12/2001	Hayes et al.	
D496,720	S *	9/2004	Dudley	D23/365
6,885,811	B2	4/2005	He et al.	
D504,943	S *	5/2005	Dudley	D23/365
7,055,764	B1	6/2006	Martinez et al.	
D544,080	S *	6/2007	Carlson	D23/364
D565,162	S *	3/2008	Carlson	D23/364
7,344,123	B2	3/2008	Pankhurst et al.	
2004/0265164	A1	12/2004	Woo et al.	
2006/0078477	A1	4/2006	Althouse et al.	
2007/0160492	A1	7/2007	Spector	
2008/0128925	A1	6/2008	Pankhurst et al.	

**FOREIGN PATENT DOCUMENTS**

WO WO 2006/010282 2/2006

**OTHER PUBLICATIONS**

Scents & Sprays, www.scentsandsprays.com/ya . . . , Yankee Autumn Bounty Electric 2 Home Air Freshener, copyright 2001-2008 scentsandsprays.com, accessed Oct. 2, 2008, 1 page.  
ecrater, www.ecrater.com/product.php? . . . , Yankee Candle Selects Two Scents Electric Fragrance Unit Macintosh/Home Sweet Home, accessed Oct. 2, 2008, 1 page.  
Aromate E-News, Innovatio nin Novelty Fragrance, http://209.85.173.104/seasrch?q=cach . . . , accessed Oct. 8, 2008, 2 pages.  
About.Com Housekeeping, http://housekeeping.about.com/od/pr . . . affresh, Febreze Noticeables, accessed Oct. 2, 2008, 2 pages.  
Irvin, Aaron, U.S. Appl. No. 29/331,512, filed Jan. 27, 2009.

\* cited by examiner

*Primary Examiner*—Sandra Snapp  
(74) *Attorney, Agent, or Firm*—Thorpe North and Western, LLP

(57) **CLAIM**

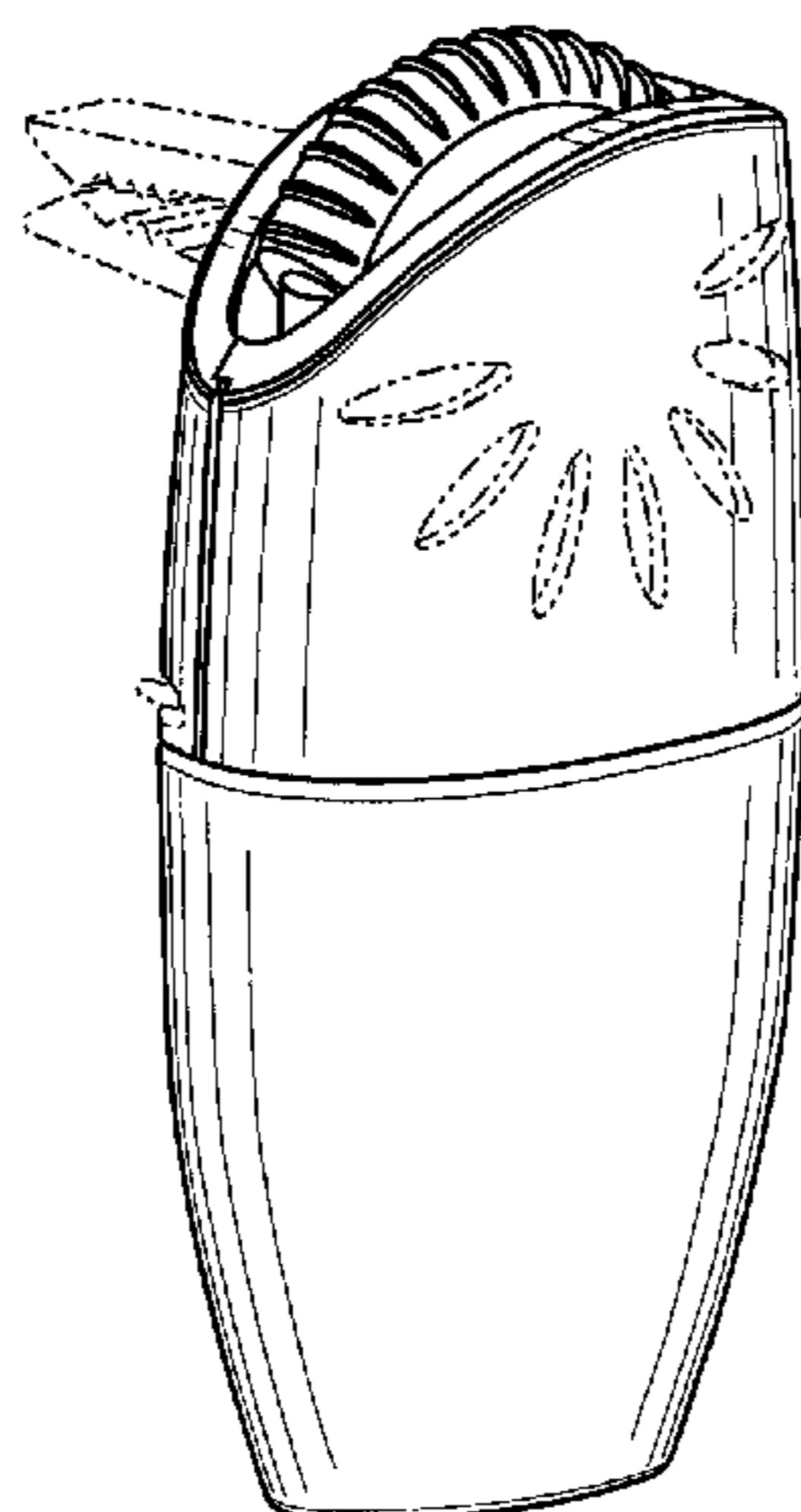
The ornamental design for the single scent air freshener, as shown and described.

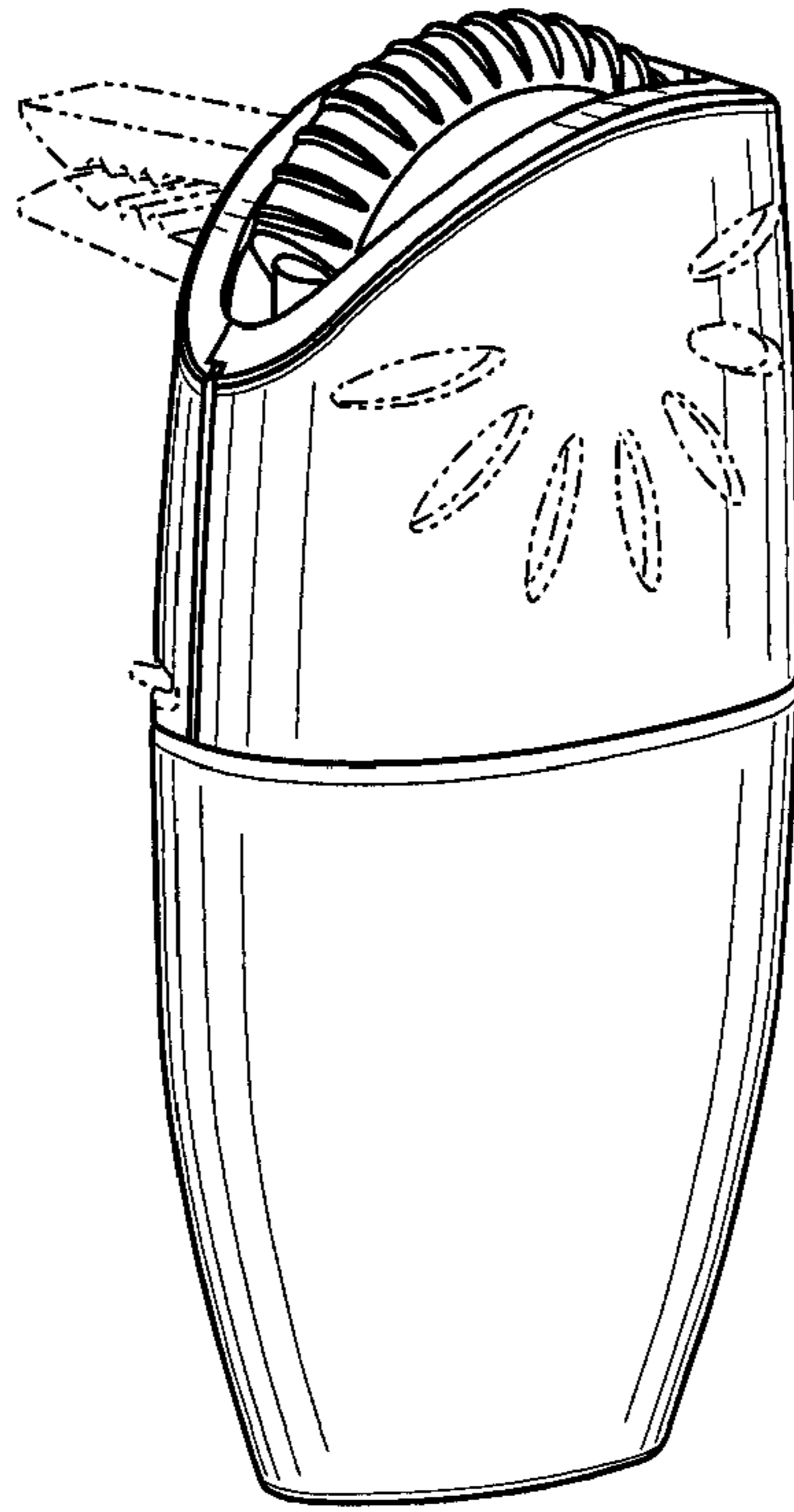
**DESCRIPTION**

FIG. 1 is an elevated, perspective view of the single scent air freshener in accordance with my invention;  
FIG. 2 is a front view thereof;  
FIG. 3 is a rear view thereof;  
FIG. 4 is a left side view thereof;  
FIG. 5 is a right side view thereof;  
FIG. 6 is a top view thereof; and,  
FIG. 7 is a bottom view thereof.

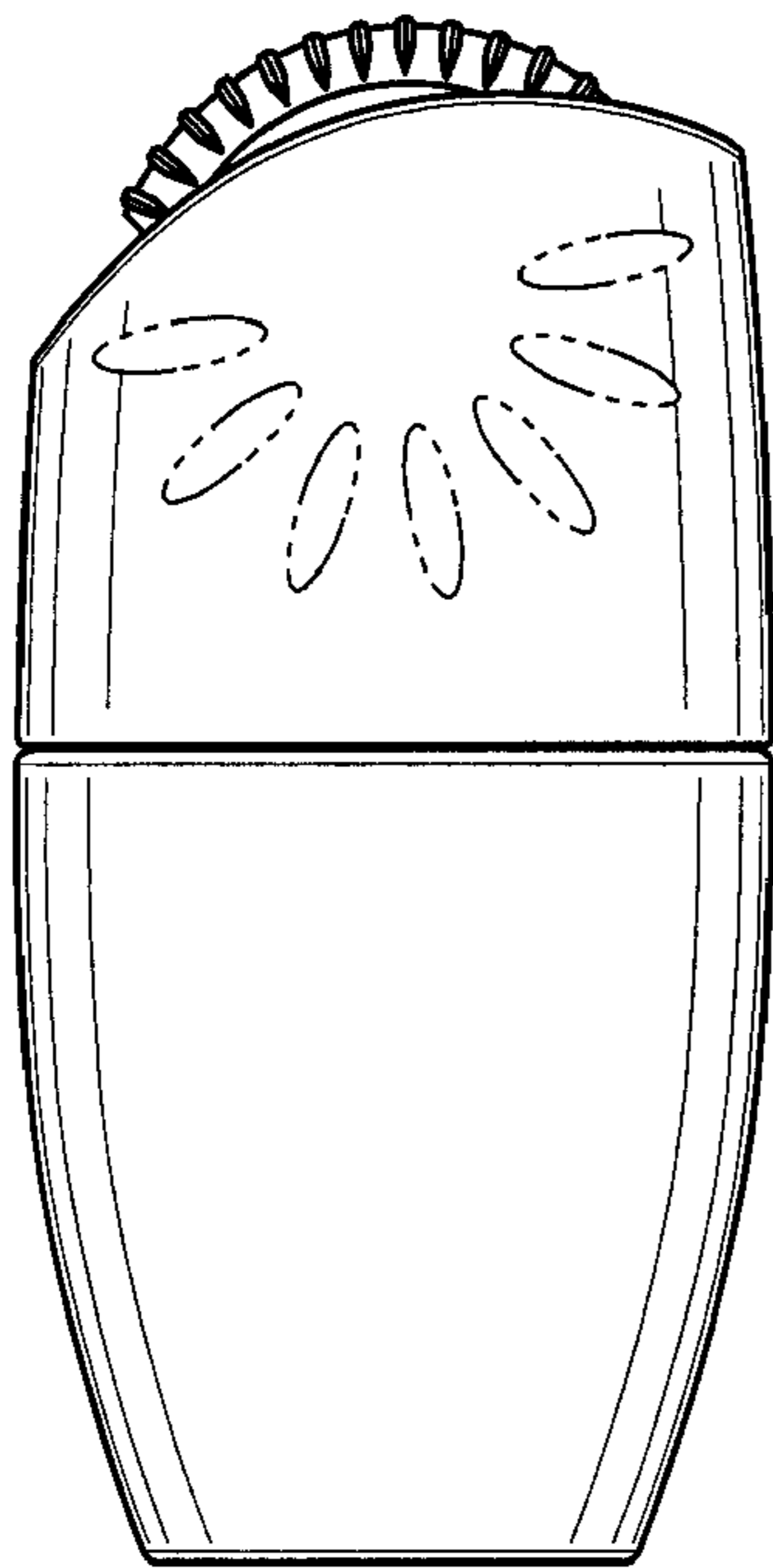
The broken lines shown in FIGS. 1-7 are for illustrative purposes only and form no part of the claimed design.

**1 Claim, 2 Drawing Sheets**

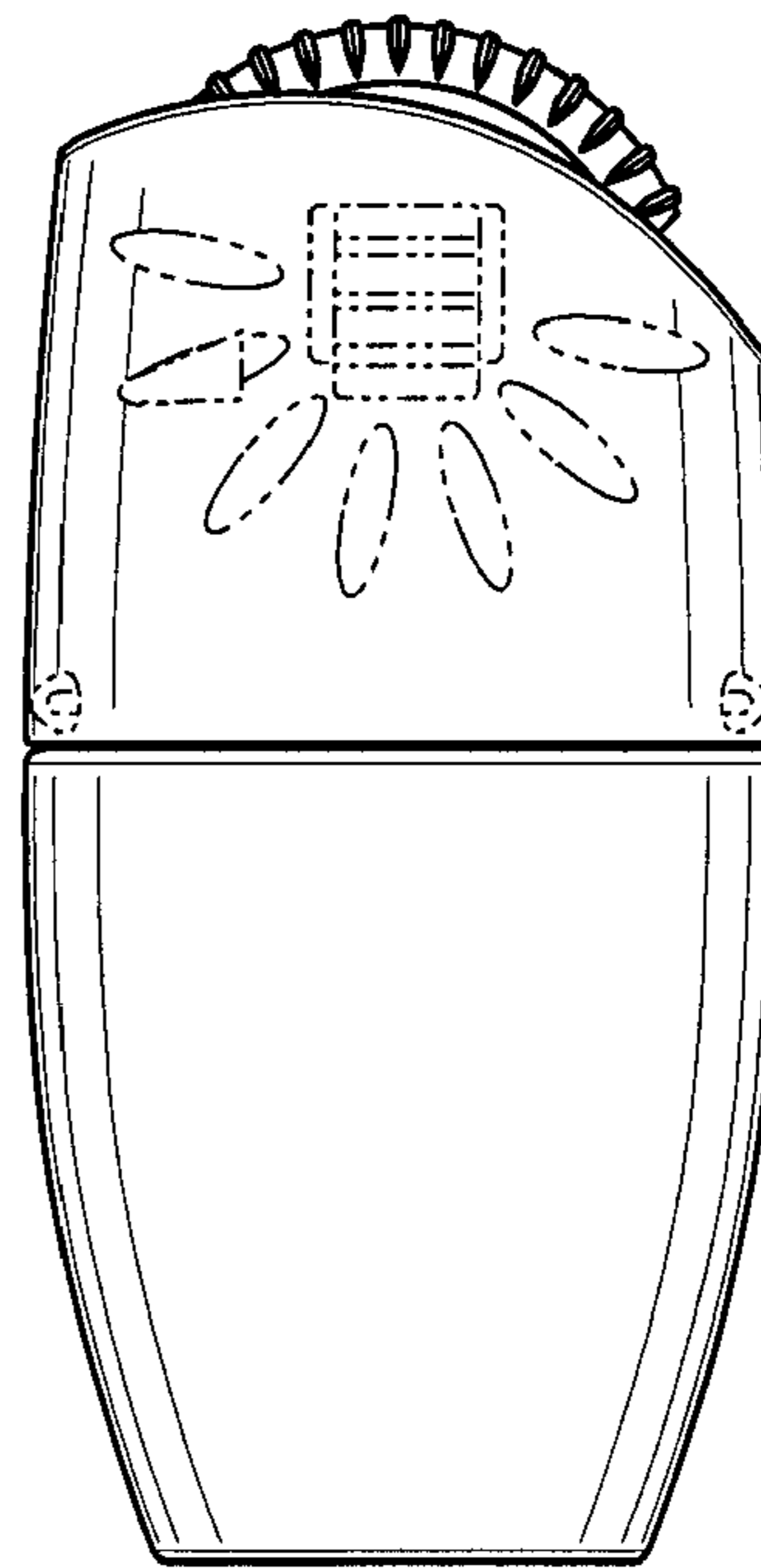




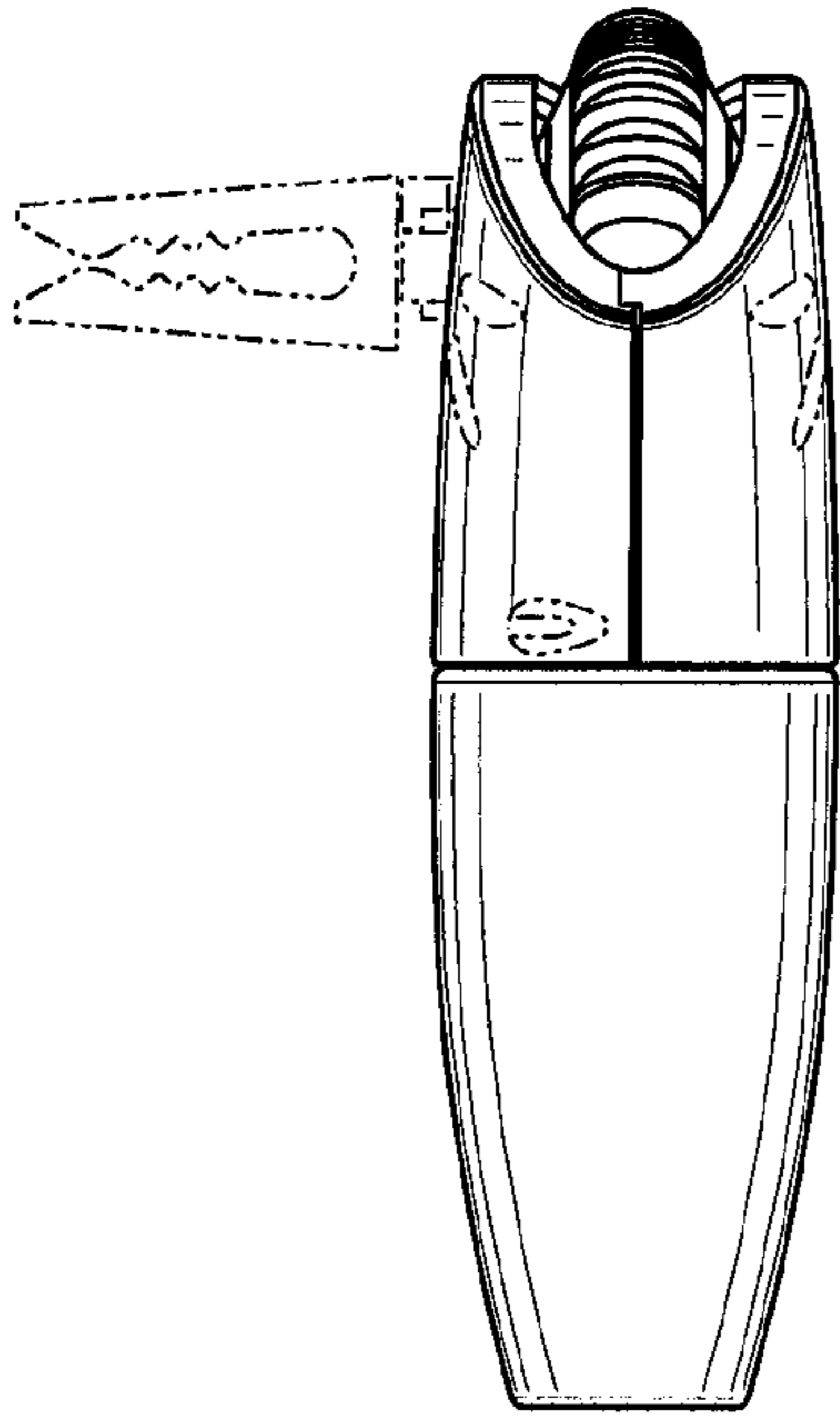
**FIG. 1**



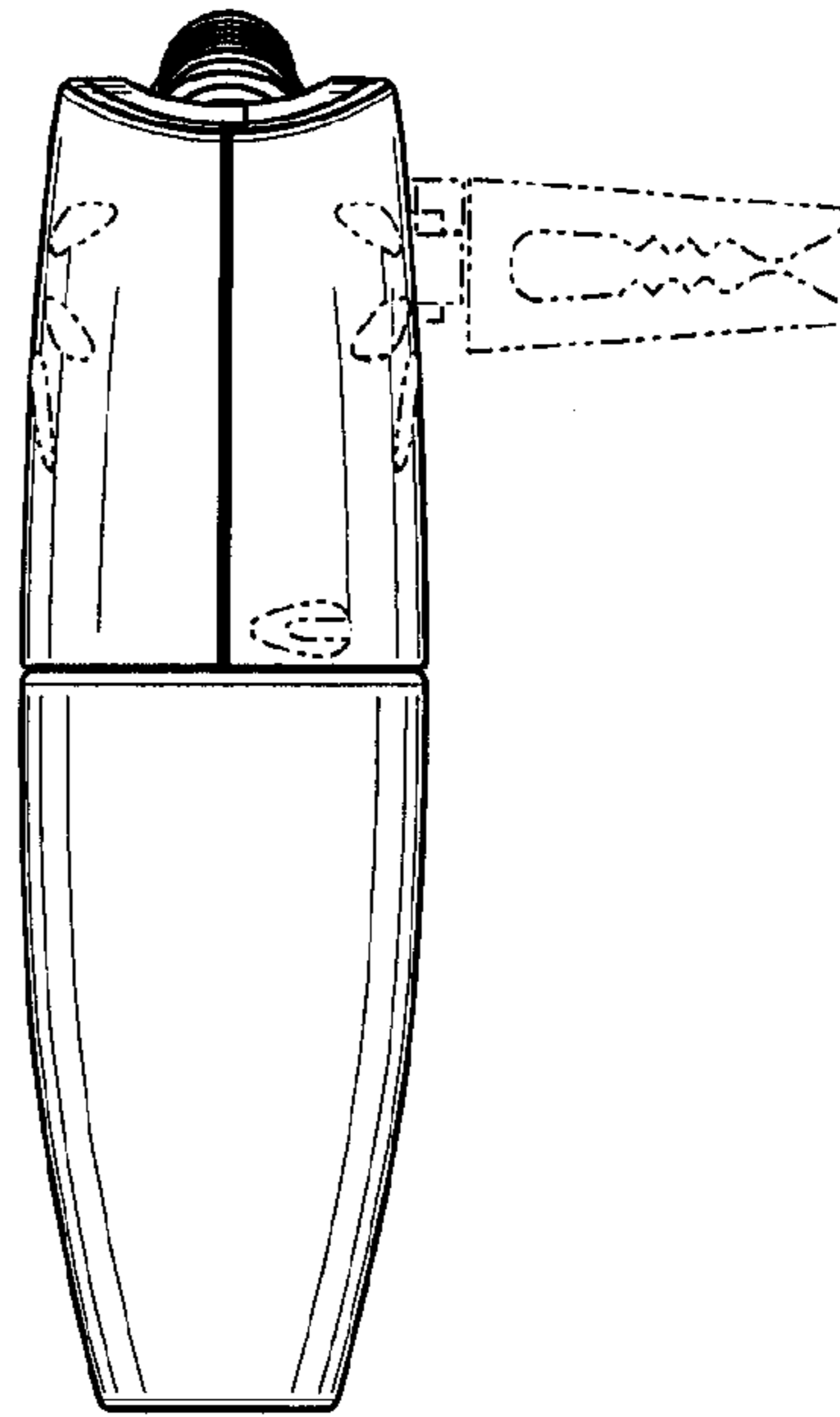
**FIG. 2**



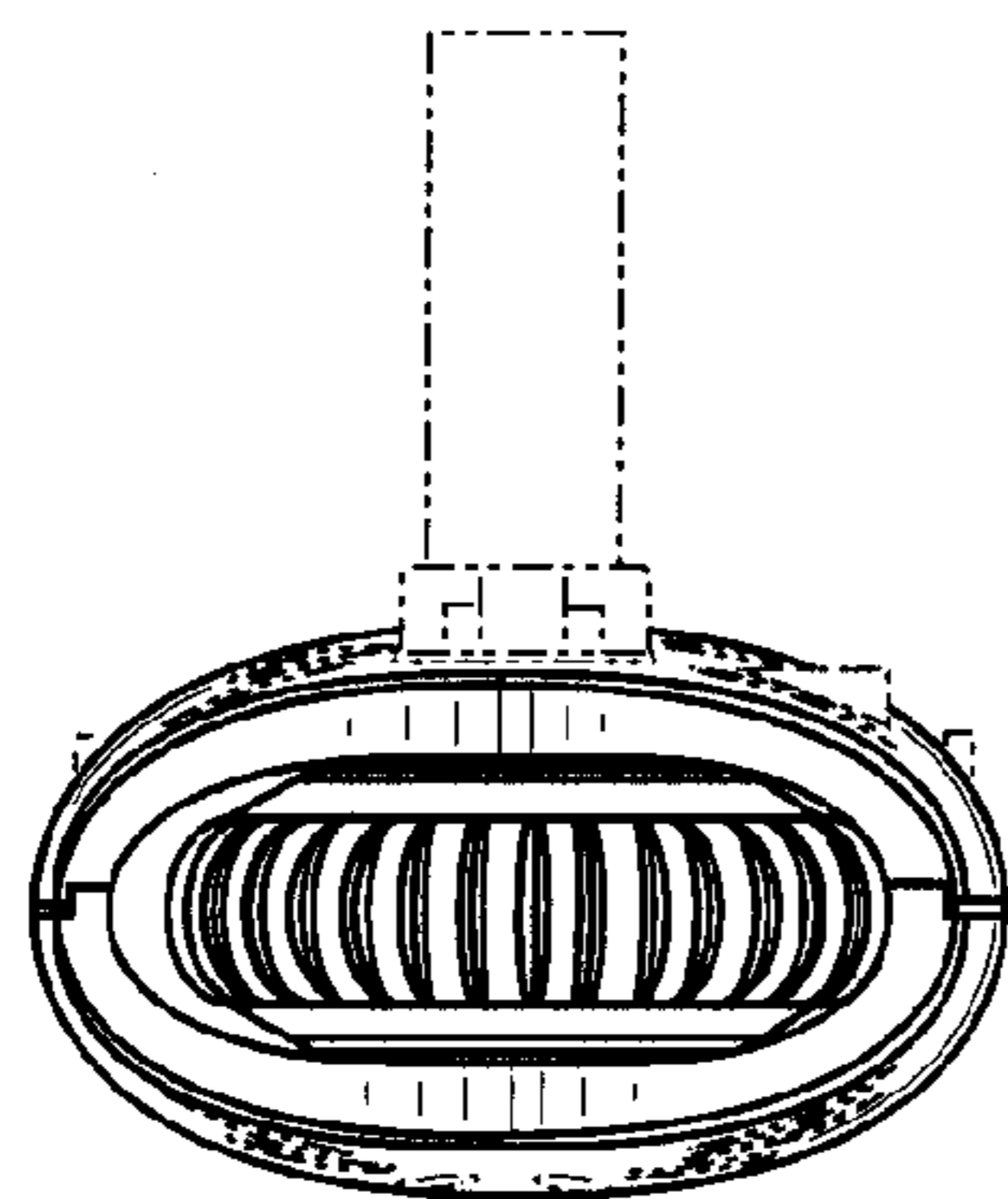
**FIG. 3**



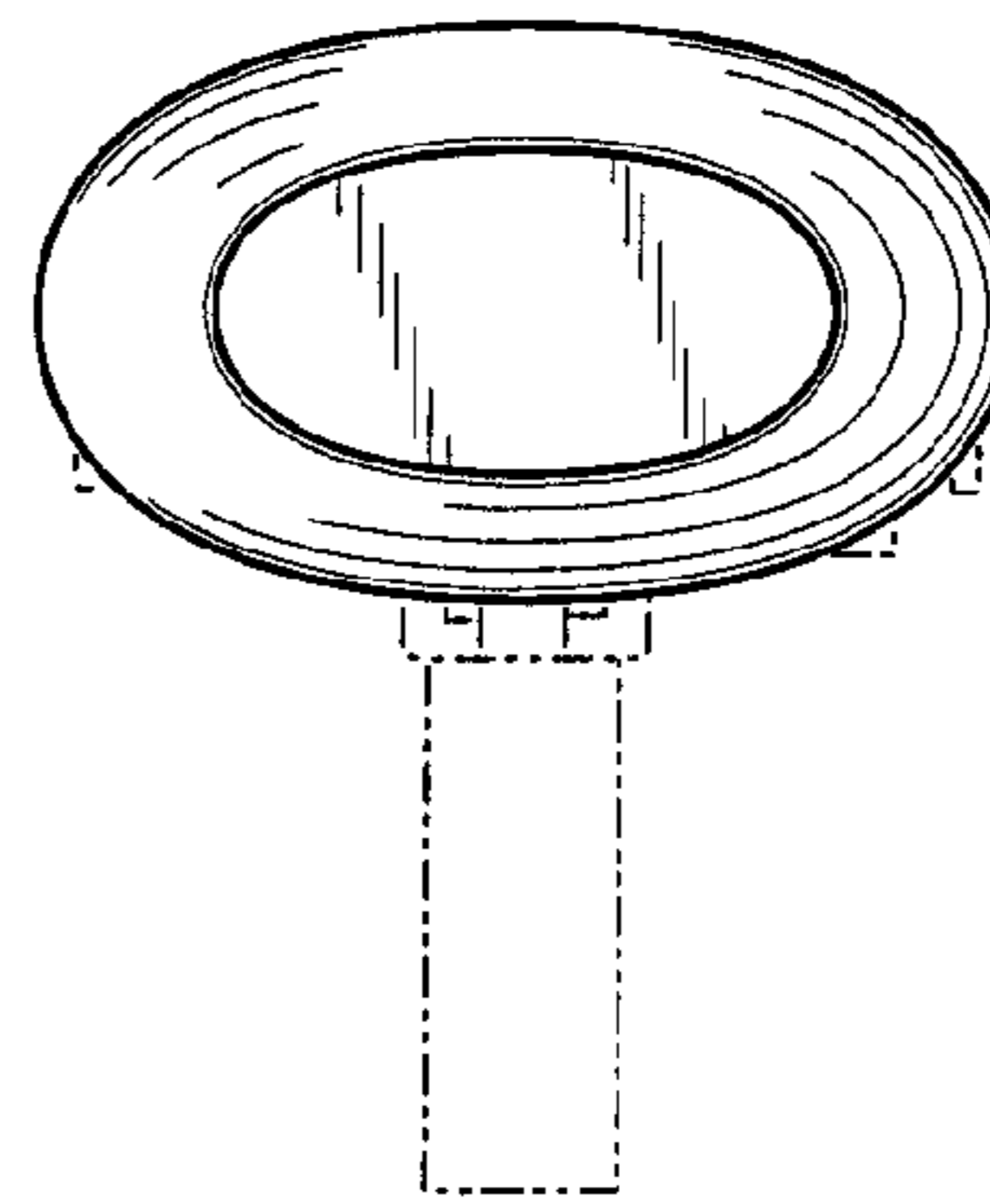
**FIG. 4**



**FIG. 5**



**FIG. 6**



**FIG. 7**