



US00D598528S

(12) **United States Design Patent**
Choi et al.

(10) **Patent No.:** **US D598,528 S**

(45) **Date of Patent:** **** Aug. 18, 2009**

(54) **DEHUMIDIFIER**

(75) Inventors: **Hwan Woong Choi**, Seoul (KR); **Ji Hyeoung Lee**, Seoul (KR)

(73) Assignee: **Samsung Electronics Co., Ltd.**, Suwon (KR)

(**) Term: **14 Years**

(21) Appl. No.: **29/330,420**

(22) Filed: **Jan. 7, 2009**

(51) **LOC (9) Cl.** **23-04**

(52) **U.S. Cl.** **D23/359**

(58) **Field of Classification Search** D23/359,
D23/356, 364, 355, 360, 366, 369, 332, 333,
D23/335, 342, 351; 422/120, 122; 55/356,
55/473, 504; 96/97; 261/DIG. 17, DIG. 65,
261/DIG. 88, DIG. 31

See application file for complete search history.

(56) **References Cited**

U.S. PATENT DOCUMENTS

- D368,770 S * 4/1996 Tanner et al. D23/359
- D395,705 S * 6/1998 Ediger et al. D23/364
- D402,746 S * 12/1998 Clark et al. D23/364
- D416,614 S * 11/1999 Bellil et al. D23/364
- D425,609 S * 5/2000 Hyon D23/359

- D442,270 S * 5/2001 Campbell et al. D23/364
- D465,567 S * 11/2002 Choi D23/364
- D503,221 S * 3/2005 Miller et al. D23/333
- D518,563 S * 4/2006 Blateri D23/335
- D551,747 S * 9/2007 Liu D23/359
- D553,229 S * 10/2007 Song et al. D23/359
- D564,646 S * 3/2008 Chen D23/351
- D573,241 S * 7/2008 Chiu D23/359

* cited by examiner

Primary Examiner—T. Chase Nelson

Assistant Examiner—David G Muller

(74) *Attorney, Agent, or Firm*—Ladas and Parry LLP

(57) **CLAIM**

The ornamental design for a dehumidifier, as shown.

DESCRIPTION

FIG. 1 is a front/right side/top perspective view of a dehumidifier showing our new design;

FIG. 2 is a front elevation view thereof;

FIG. 3 is a rear elevation view thereof;

FIG. 4 is a left side elevation view thereof;

FIG. 5 is a right side elevation view thereof;

FIG. 6 is a top plan view thereof; and,

FIG. 7 is a bottom plan view thereof.

1 Claim, 6 Drawing Sheets

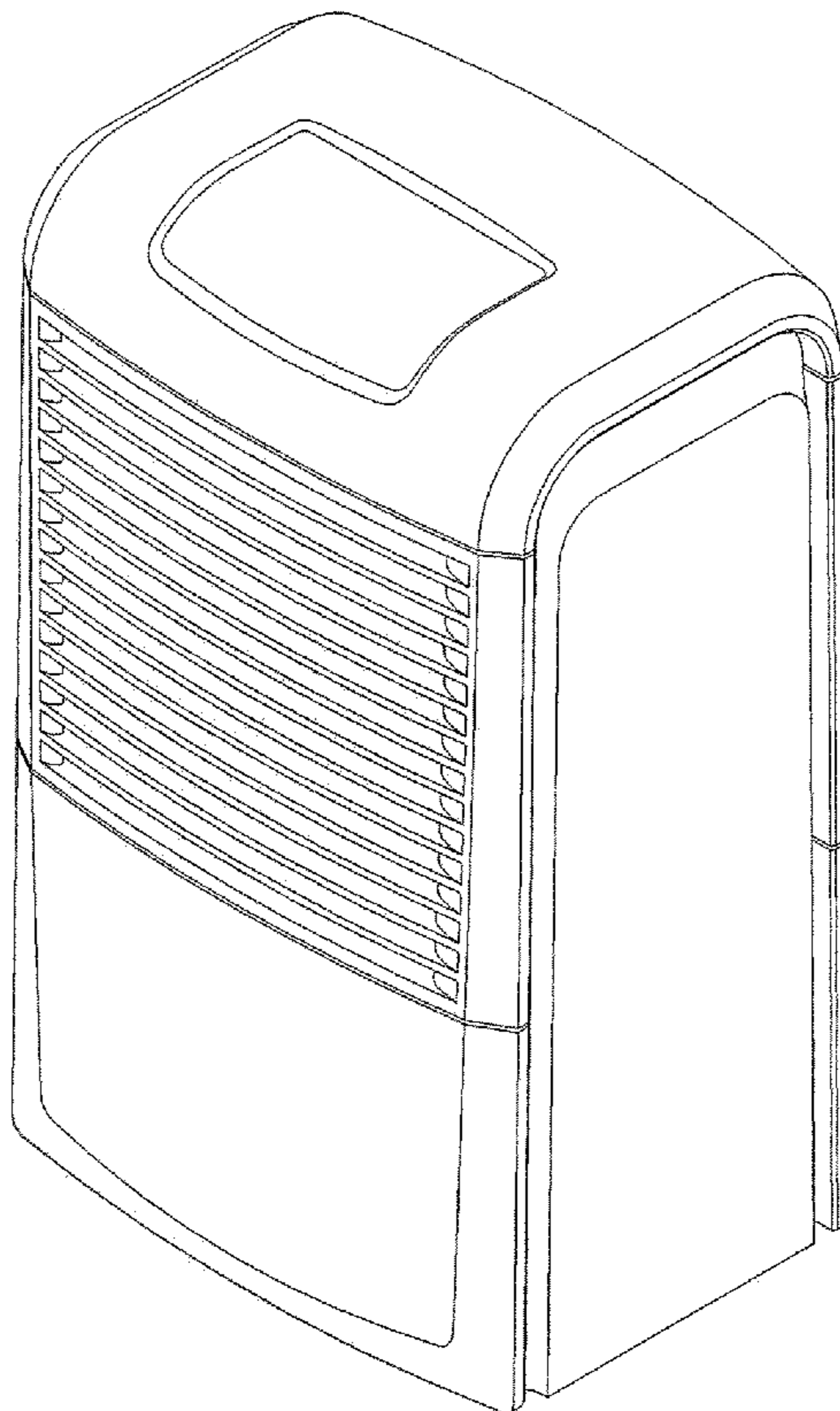

FIG. 1

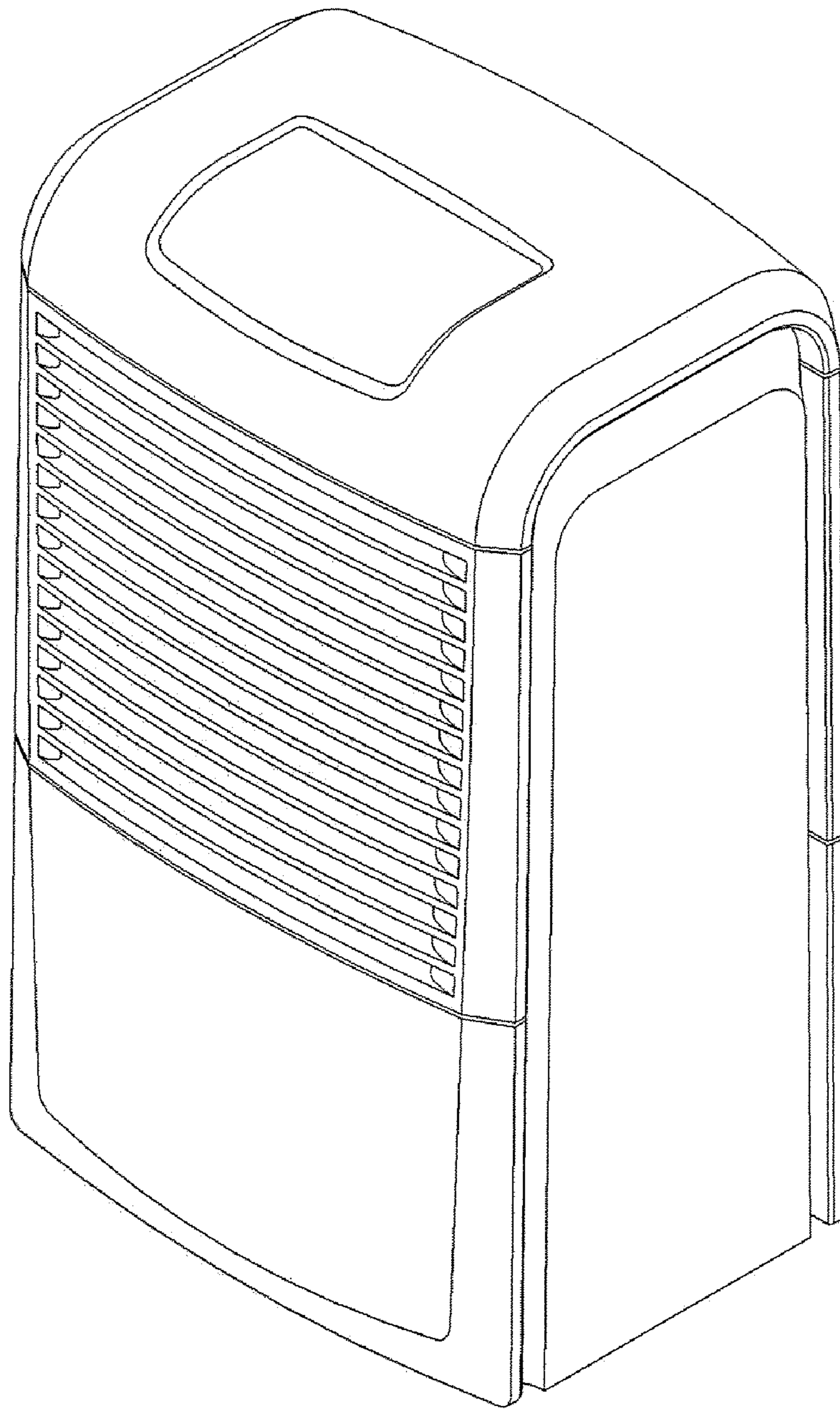

FIG. 2

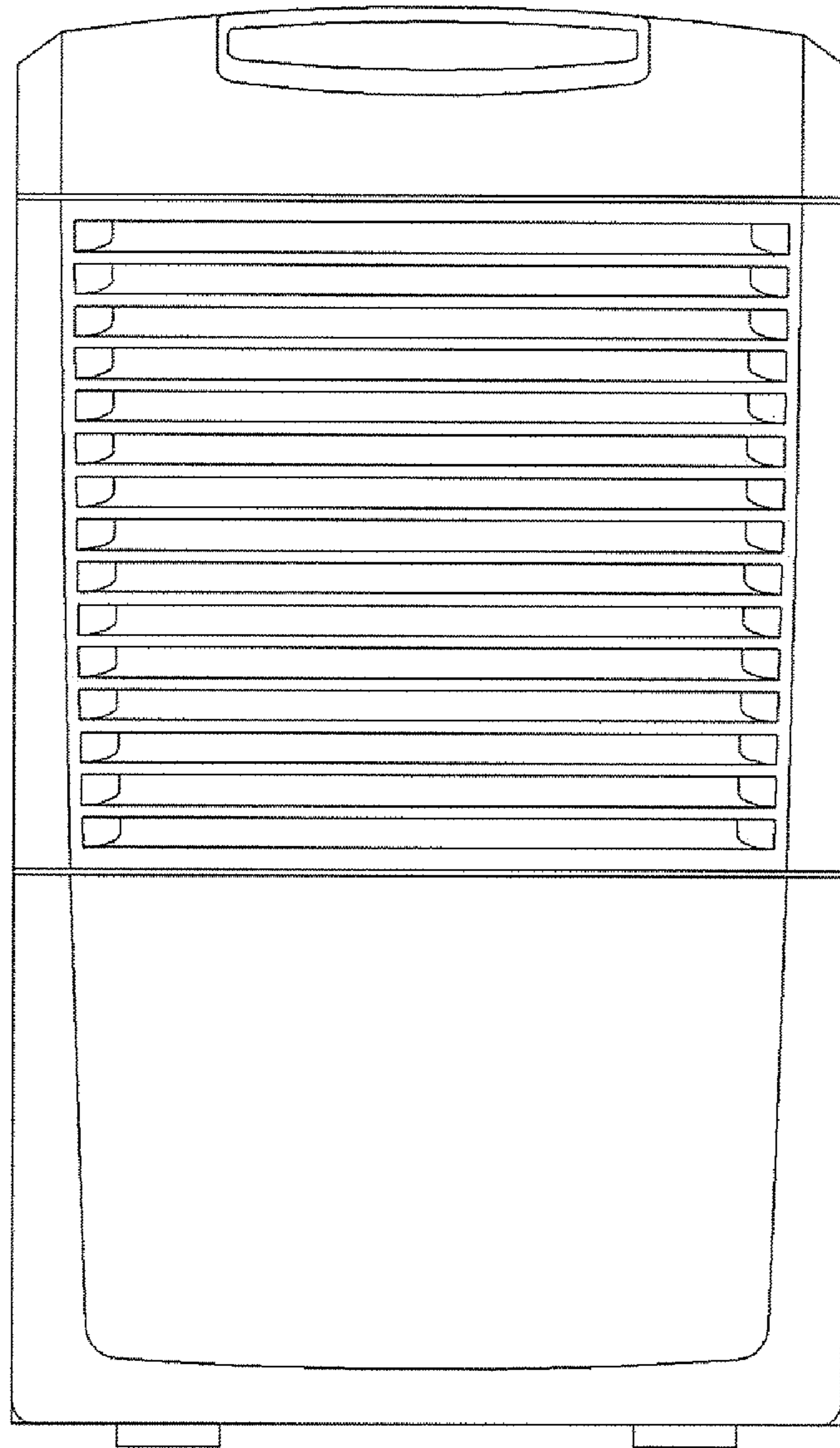

FIG. 3

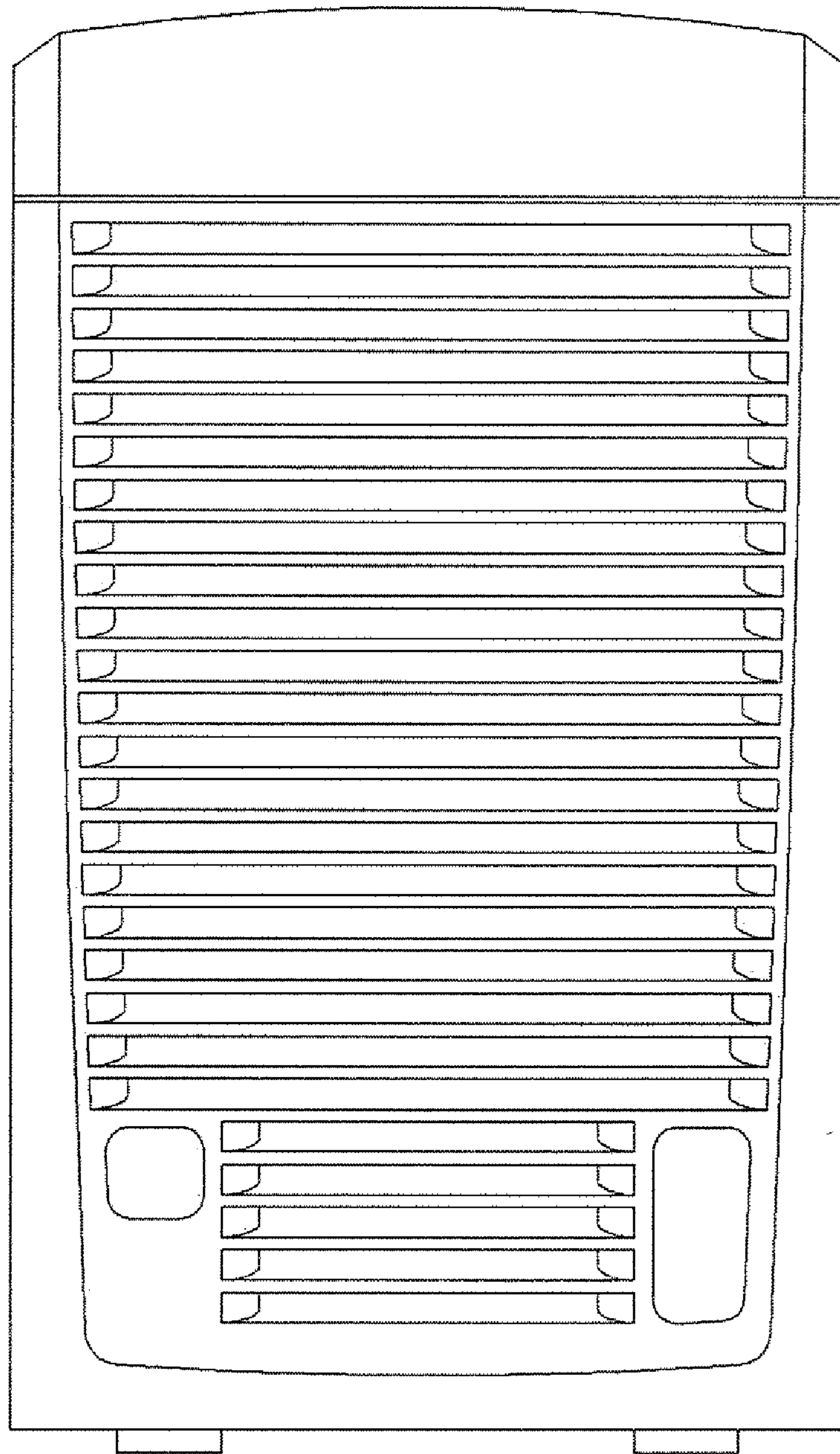

FIG. 4

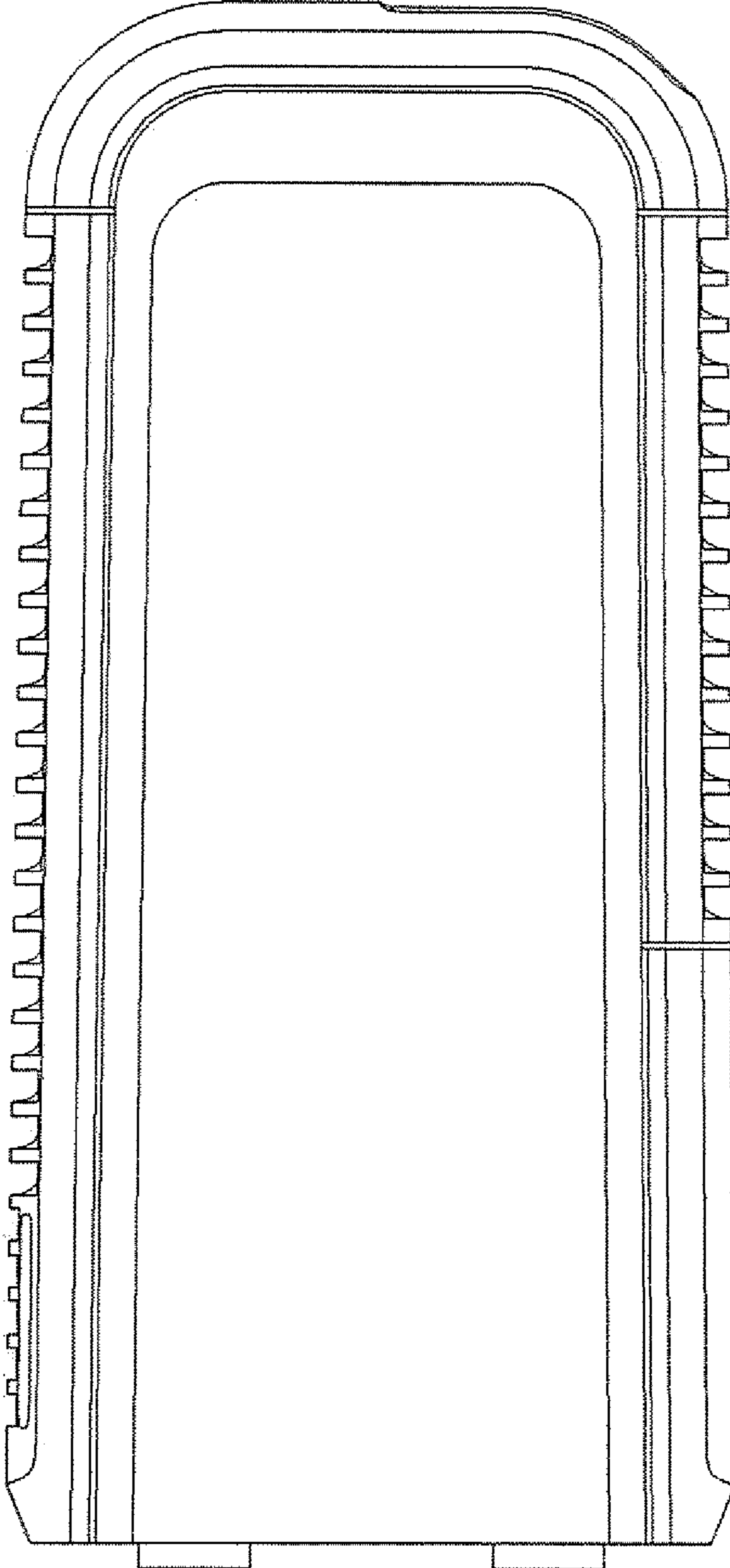

FIG. 5

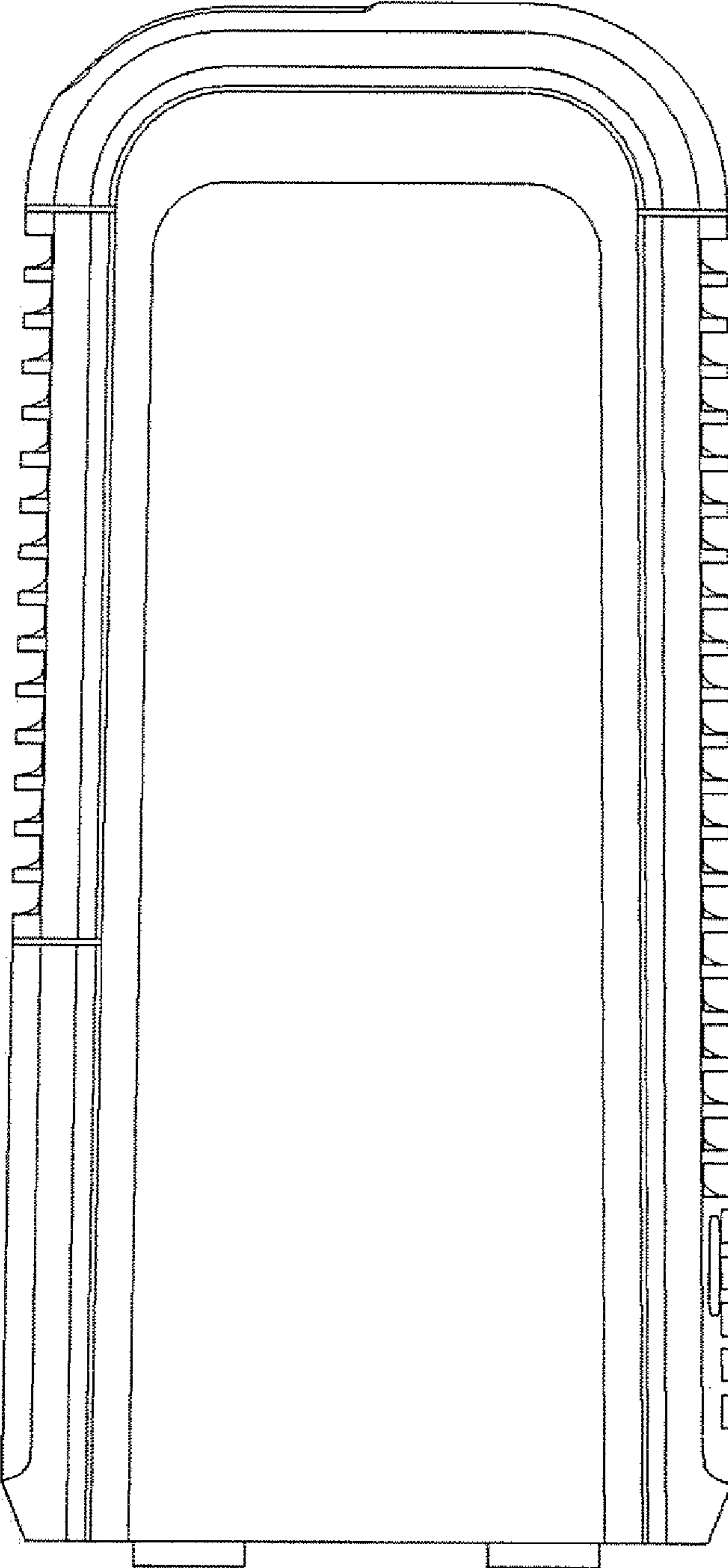

FIG. 6

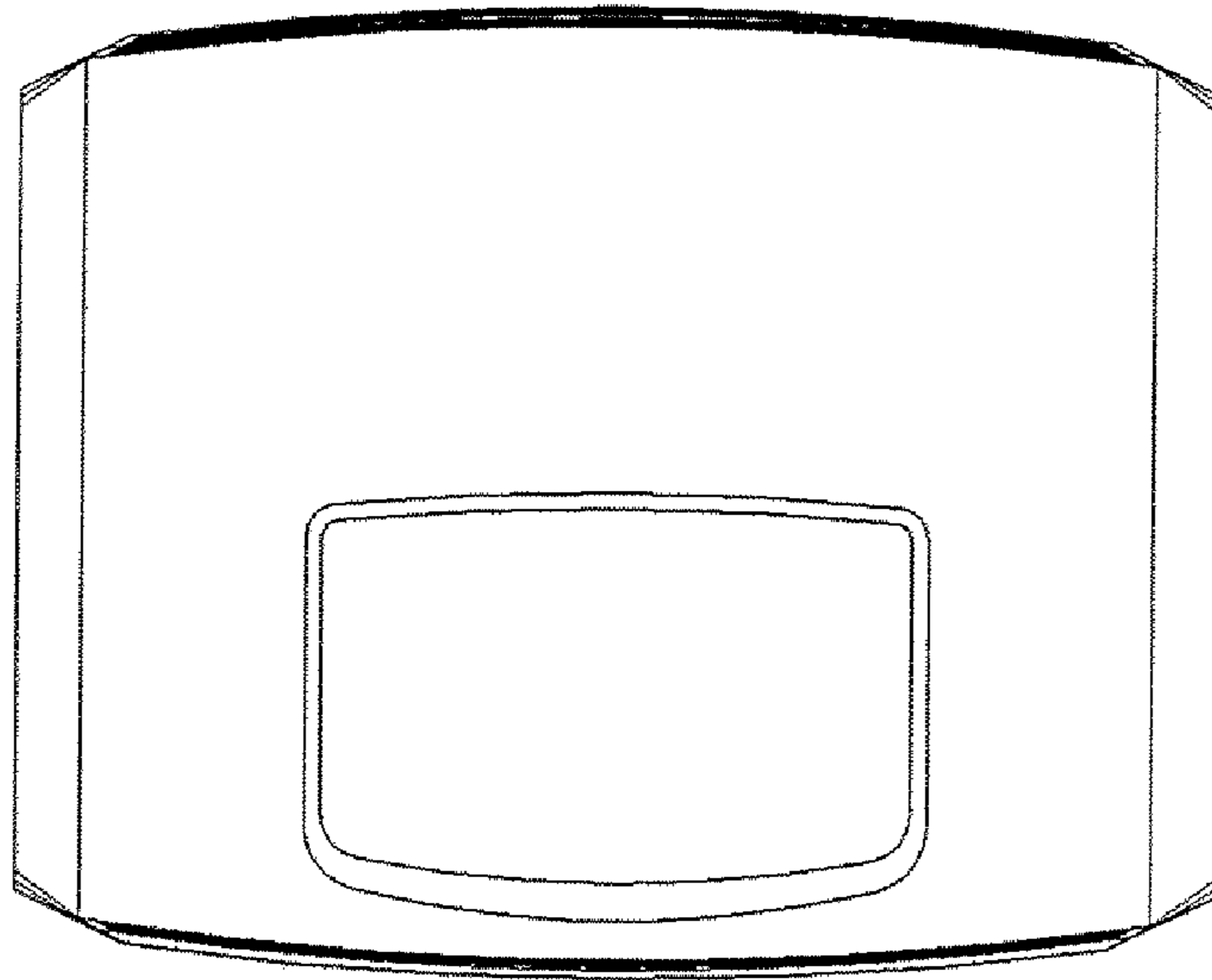

FIG. 7

