



US00D598239S

(12) **United States Design Patent**  
**Mah et al.**

(10) **Patent No.:** **US D598,239 S**

(45) **Date of Patent:** **\*\* Aug. 18, 2009**

(54) **LEG SUPPORTED FOOD PROCESSOR**

4,546,928 A \* 10/1985 Suzuki ..... 241/95  
5,445,332 A \* 8/1995 Shimizu et al. .... 241/100  
D564,829 S \* 3/2008 Cohen et al. .... D7/384

(75) Inventors: **Pat Y. Mah**, Kowloon (HK); **Alexander Joseph Kalogroulis**, Coulsdon (GB)

\* cited by examiner

(73) Assignee: **Daka Research Inc. (Br. Virg. Isl Corp.) Offshore Incorporation**, Tortolla (VG)

*Primary Examiner*—Caron Veynar

*Assistant Examiner*—Ricky Pham

(\*\*) Term: **14 Years**

(74) *Attorney, Agent, or Firm*—Curtis L. Harrington; Kathy E. Harrington; Harrington & Harrington

(21) Appl. No.: **29/307,654**

(57) **CLAIM**

(22) Filed: **May 1, 2008**

The ornamental design for a leg supported food processor, as shown and described.

**Related U.S. Application Data**

**DESCRIPTION**

(63) Continuation-in-part of application No. 29/294,614, filed on Jan. 17, 2008, now abandoned.

FIG. 1 is a perspective view of the leg supported food processor, showing our new design;

(51) **LOC (9) Cl.** ..... **31-00**

(52) **U.S. Cl.** ..... **D7/384**

FIG. 2 is a rear view;

(58) **Field of Classification Search** ..... D7/317-318,

D7/356, 376-386, 392, 412-415, 665; D9/449;

99/348, 509-511; 241/30-37.5, 95, 100,

241/101.01-101.2, 166-169.1, 274-278.2,

241/285.1-285.3, 291; 366/64-67, 98, 192,

366/197-211, 205-206, 241-254, 279-292,

366/341-343

FIG. 3 is a front view;

FIG. 4 is a right side view;

FIG. 5 is a left side view;

FIG. 6 is a top view;

FIG. 7 is a bottom view; and,

See application file for complete search history.

FIG. 8 is a perspective view showing the legs removed and re-attached in an upward position with respect to the main portion to illustrate a storage configuration.

(56) **References Cited**

The broken lines shown in the drawings are for illustrative purposes only and form no part of the claimed design.

**U.S. PATENT DOCUMENTS**

D250,568 S \* 12/1978 Belinkoff ..... D7/384

D267,538 S \* 1/1983 Steinkamp et al. .... D7/386

**1 Claim, 6 Drawing Sheets**

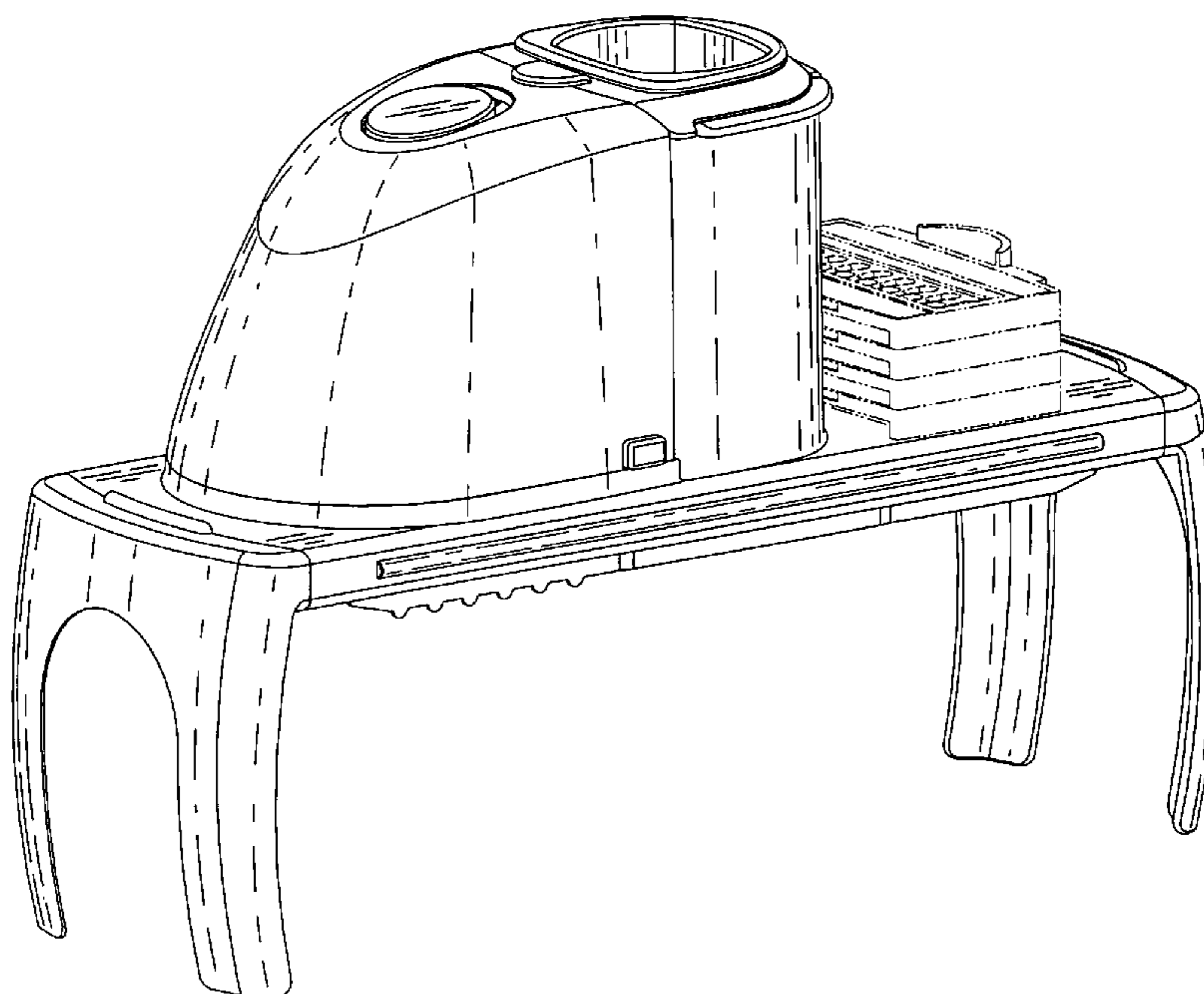

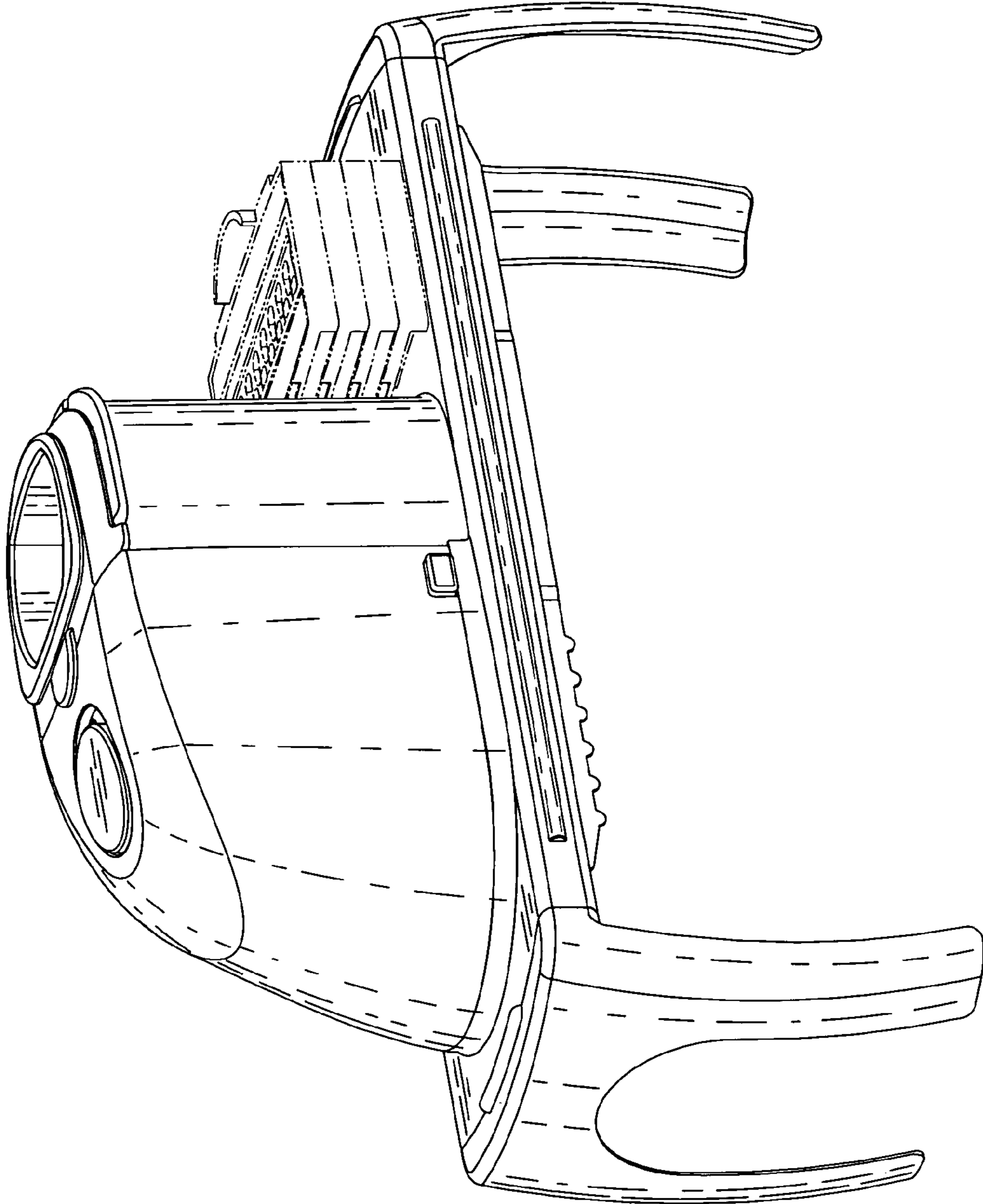

Fig. 1

Fig. 3

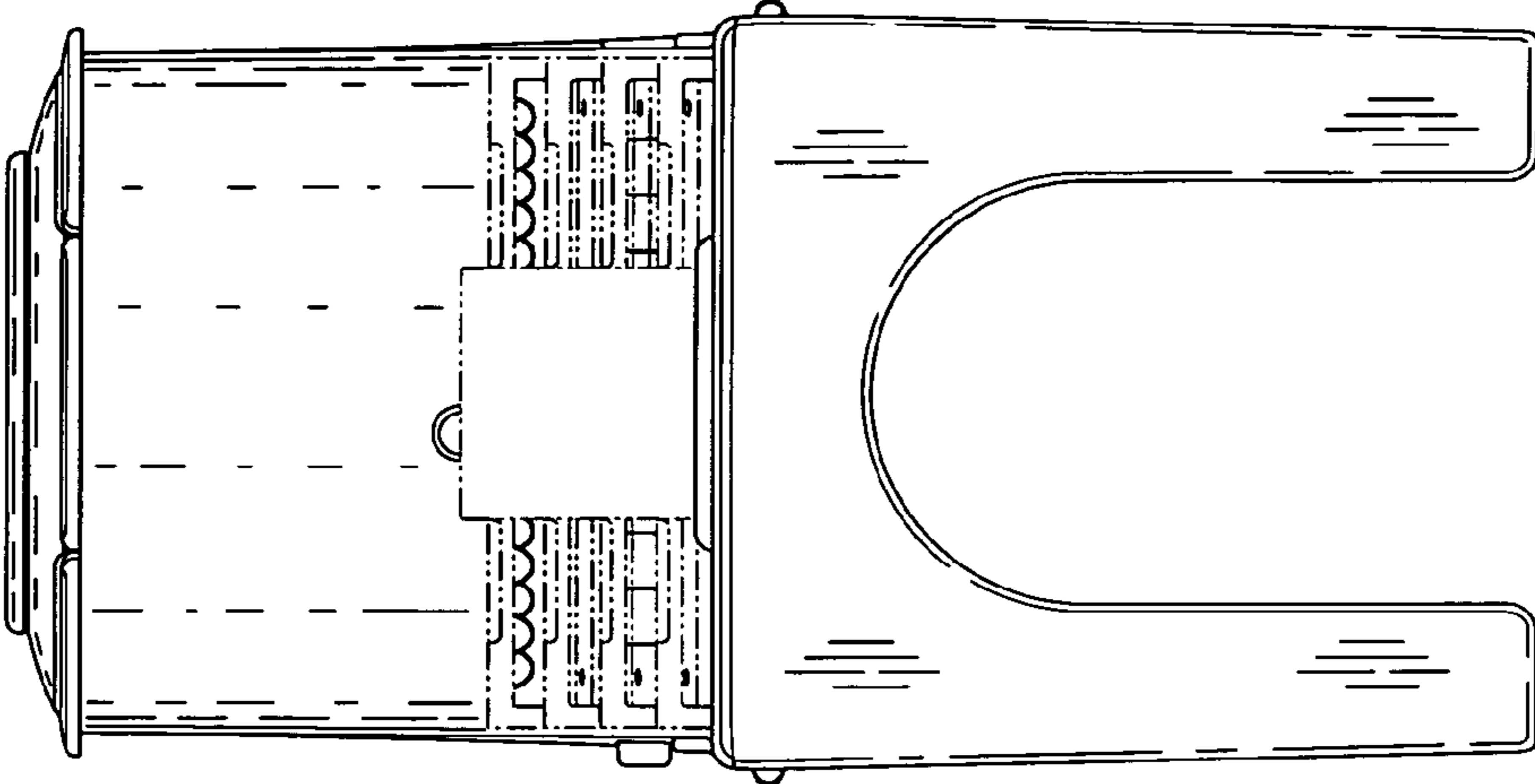
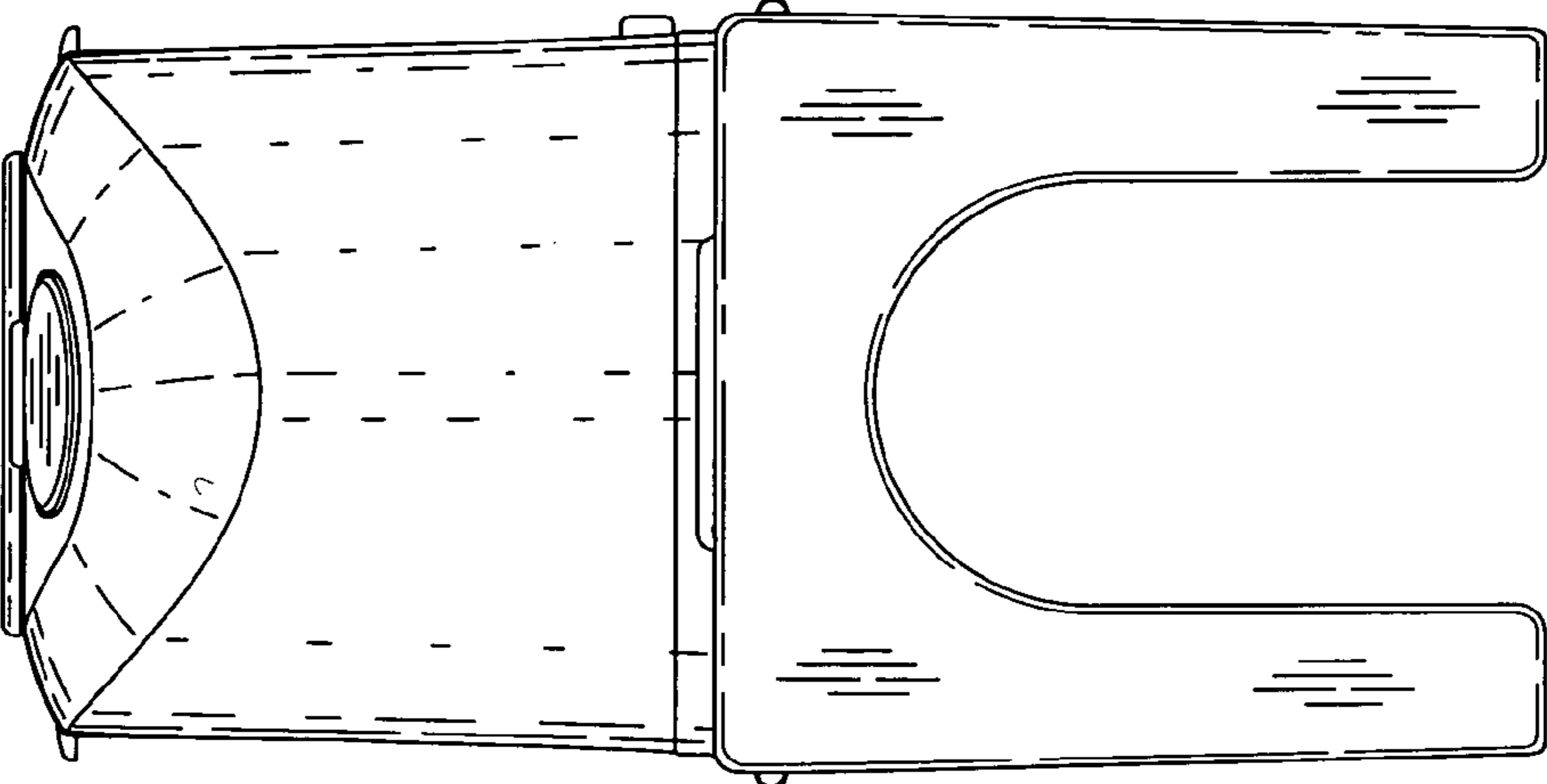

Fig. 2



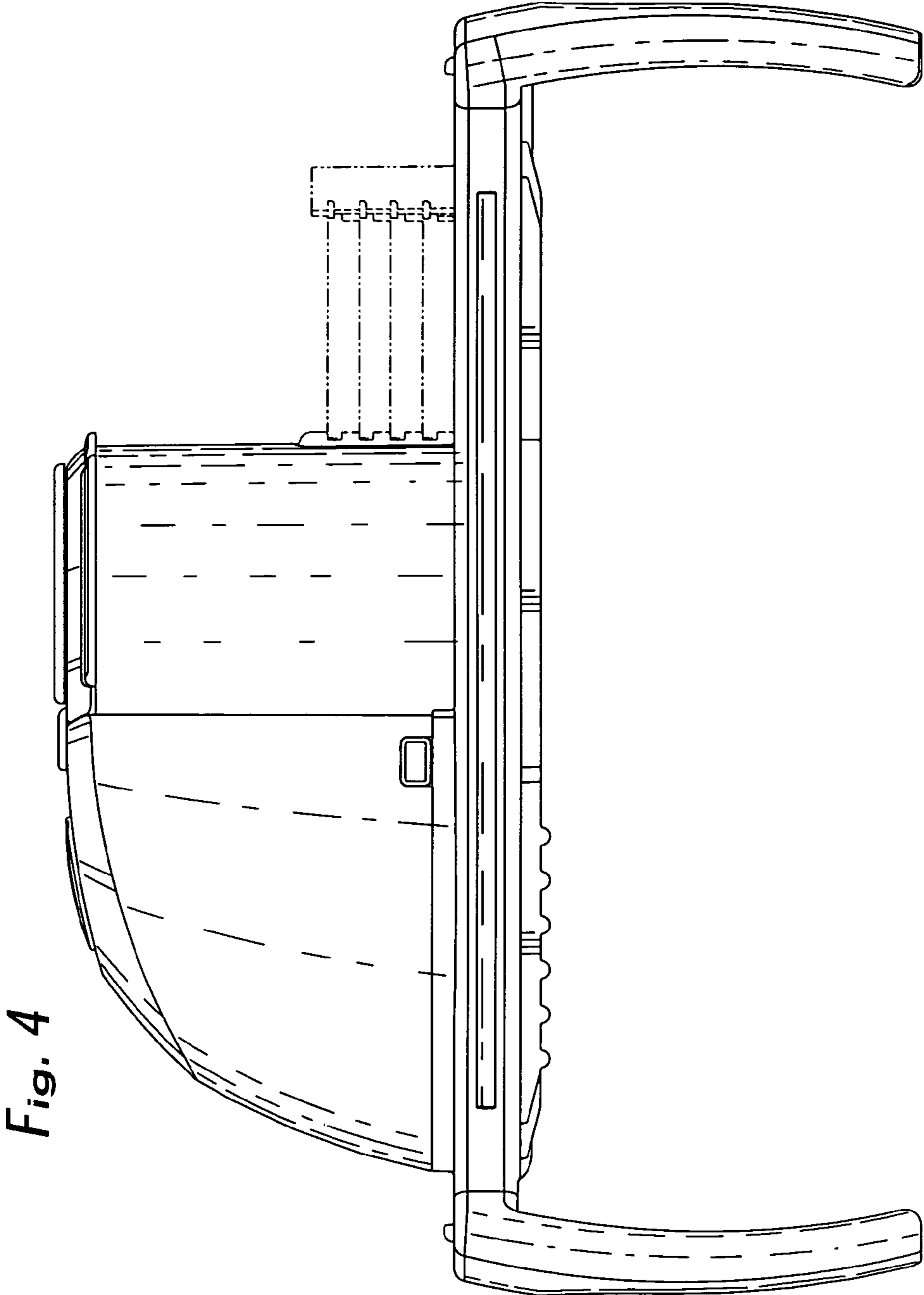

Fig. 4

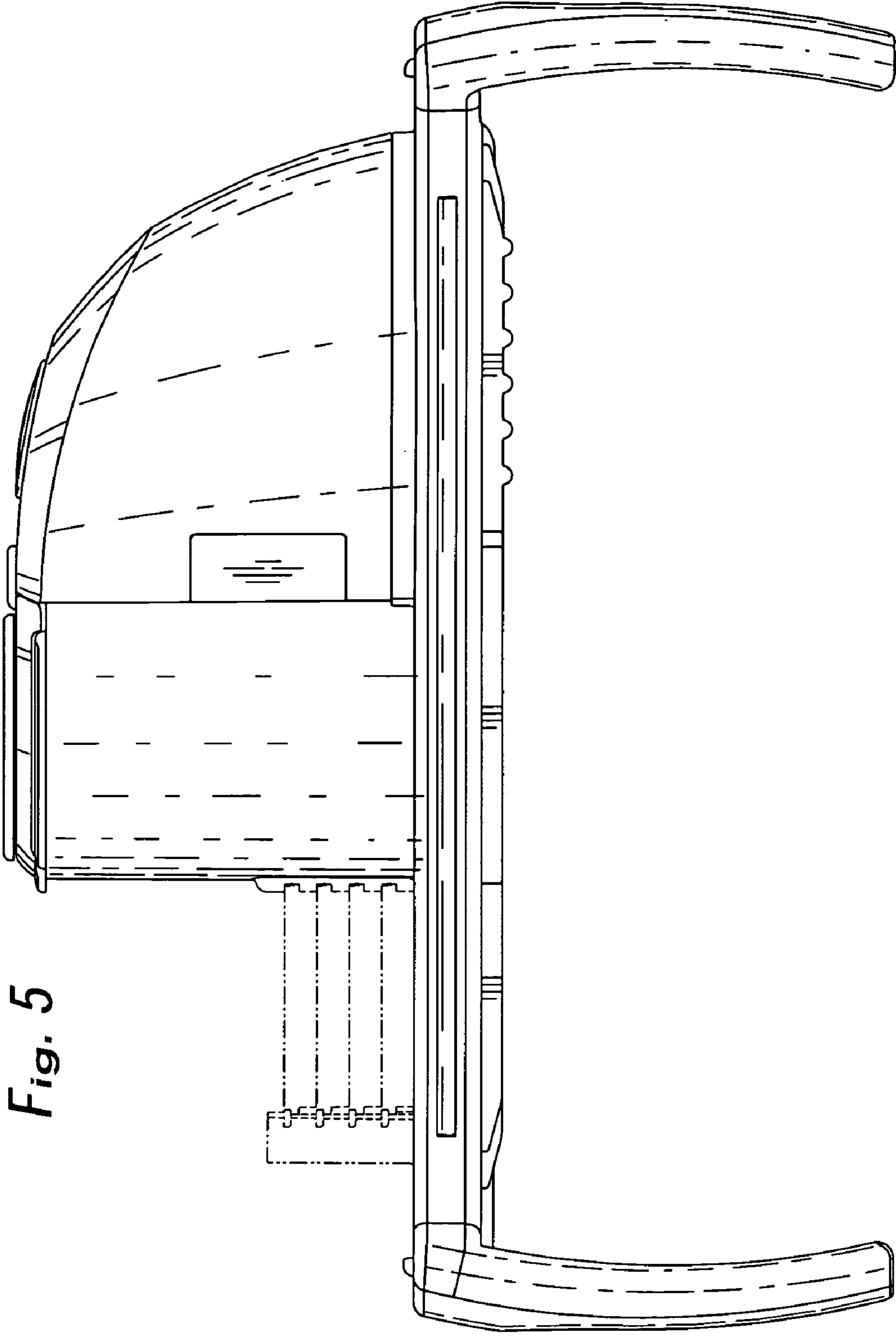
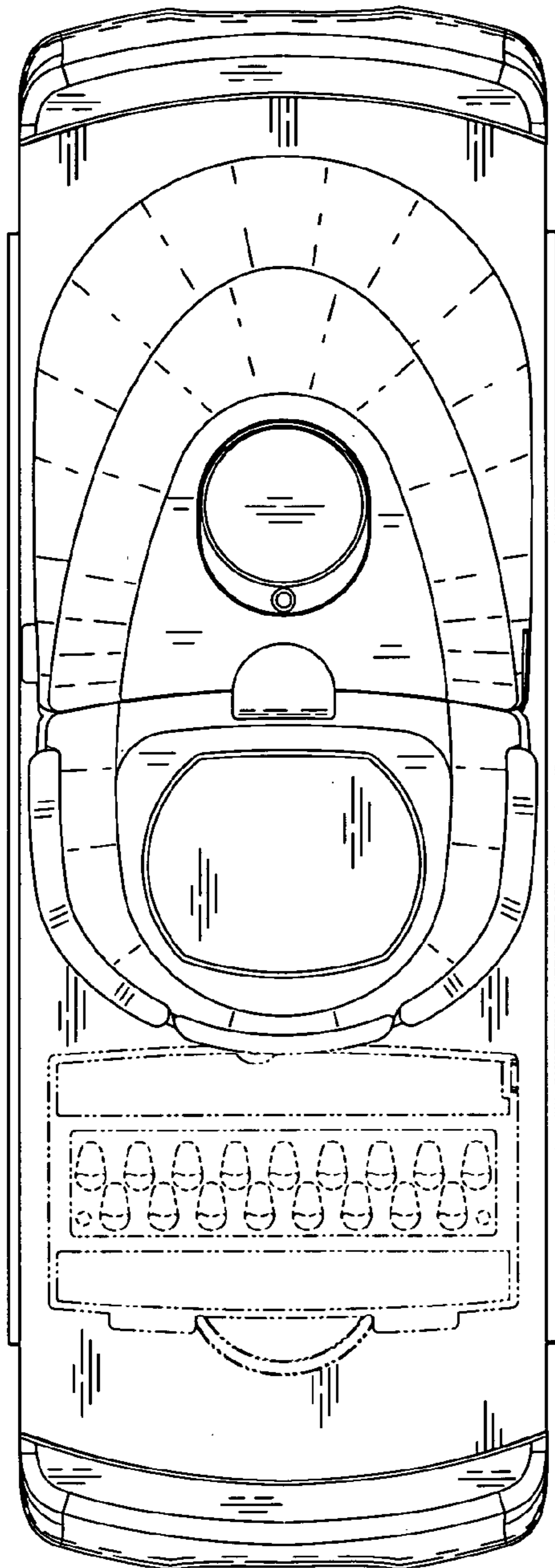
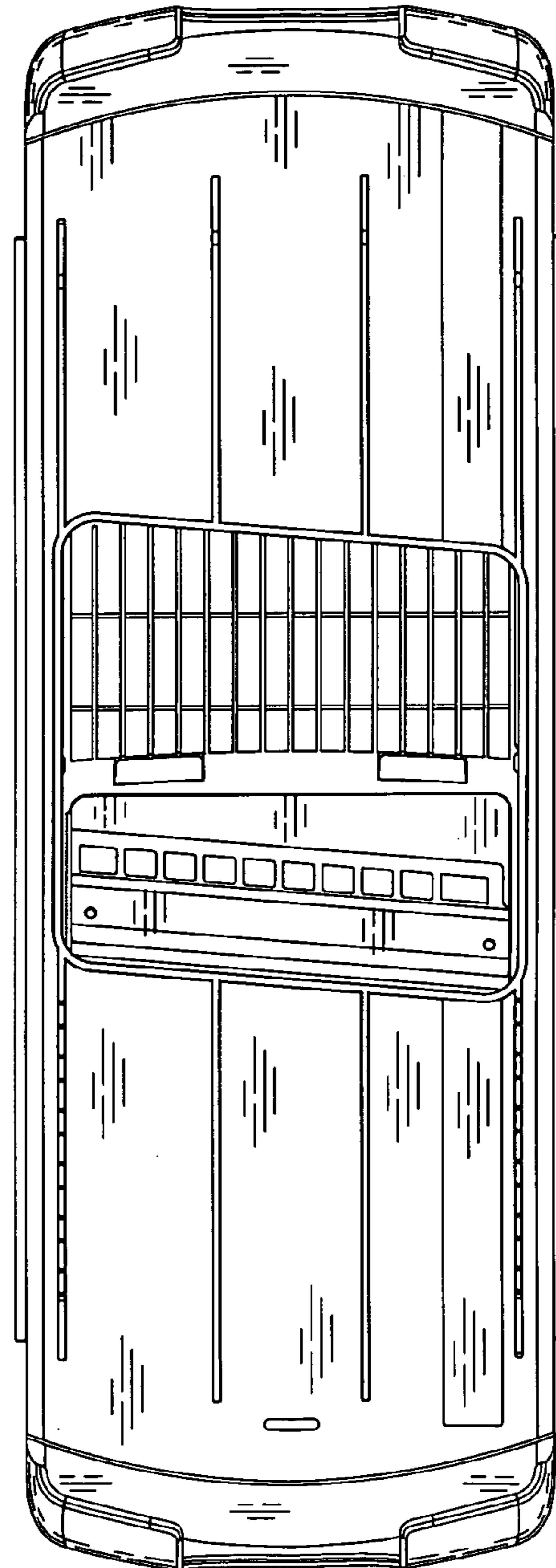

Fig. 5

*Fig. 6*



*Fig. 7*





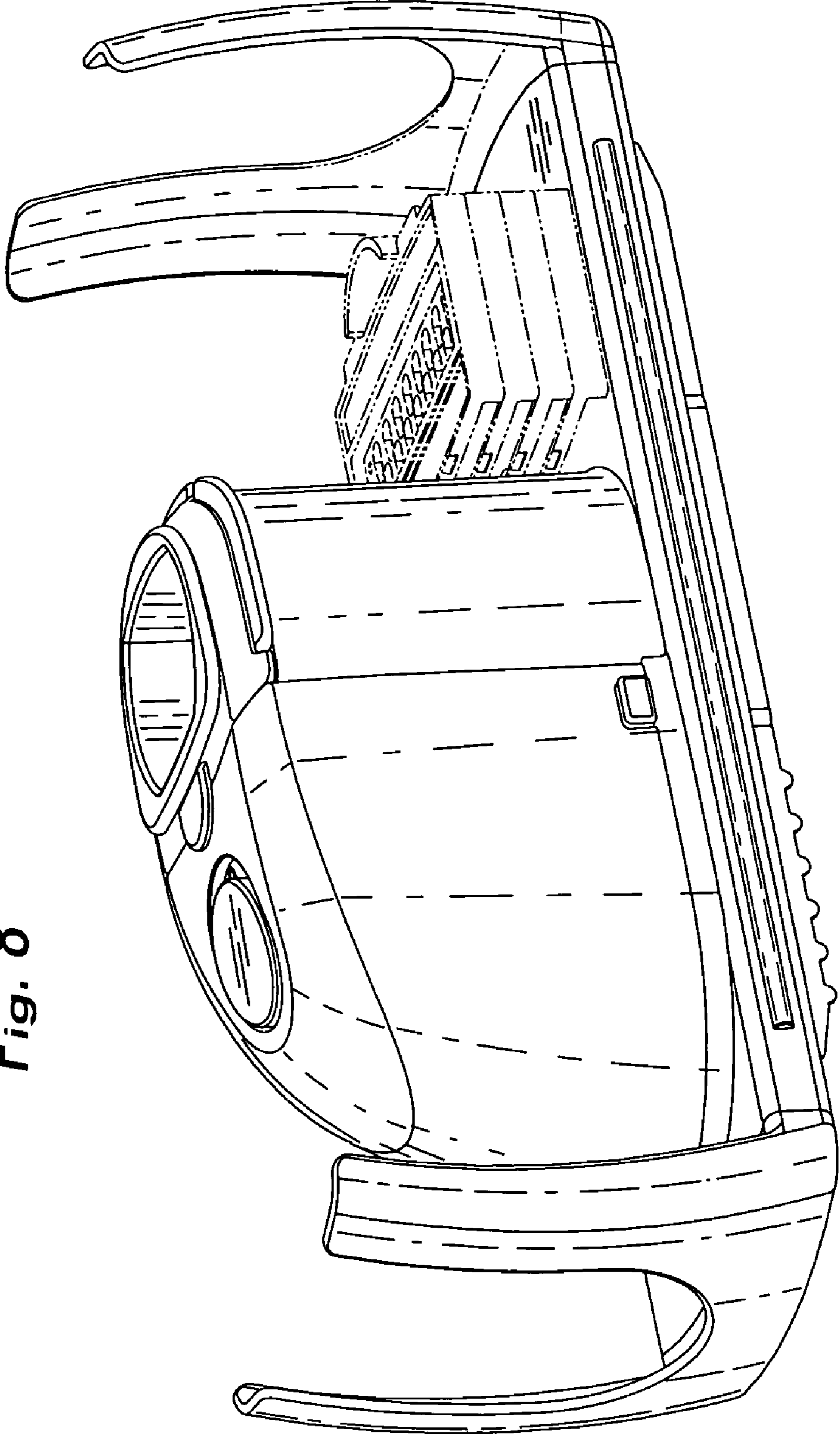

Fig. 8