



US00D598165S

(12) **United States Design Patent**
Platek

(10) **Patent No.:** **US D598,165 S**

(45) **Date of Patent:** **** Aug. 11, 2009**

(54) **COMBINED EPILATOR WITH INTEGRATED TWEEZERS**

(75) Inventor: **Avner Platek**, Tokyo (JP)

(73) Assignee: **K.I.S., Ltd.**, Hungghom, Kowloon (HK)

(**) Term: **14 Years**

(21) Appl. No.: **29/319,725**

(22) Filed: **Jun. 13, 2008**

(51) **LOC (9) Cl.** **28-03**

(52) **U.S. Cl.** **D28/44.1; D28/55**

(58) **Field of Classification Search** 30/34.05,
30/34.1, 34.2, 43-43.92, 44-45, 526, 527;
D28/44, 44.1, 49-54, 55; 606/131, 133

See application file for complete search history.

(56) **References Cited**

U.S. PATENT DOCUMENTS

D175,259 S *	8/1955	Johnson	D28/55
D367,947 S *	3/1996	Kip et al.	D28/51
D397,513 S *	8/1998	Tu et al.	D28/51
D423,720 S *	4/2000	Nielsen et al.	D28/53
D447,282 S *	8/2001	Yiu	D28/44.1
D499,842 S *	12/2004	Yiu	D28/44.1
D537,208 S *	2/2007	Shaljian	D28/55
2007/0239174 A1 *	10/2007	Yiu	606/133

* cited by examiner

Primary Examiner—Jennifer Rivard

(74) *Attorney, Agent, or Firm*—White & Case LLP

(57) **CLAIM**

The ornamental design for a combined epilator and integrated tweezers, as shown and described.

DESCRIPTION

FIG. 1 is a left side view of the epilator illustrating the new design, wherein the head of the epilator is covered by a

housing cap, and the accompanying tweezers are installed in the epilator body to form an integrated unit;

FIG. 2 is a front view thereof;

FIG. 3 is a right side view thereof;

FIG. 4 is a rear view thereof;

FIG. 5 is a front perspective view thereof;

FIG. 6 is a rear perspective view thereof, and

FIG. 7 is a bottom perspective view thereof.

FIG. 8 is a left side view of the epilator illustrating the new design, wherein the housing cap has been removed from the epilator head and the accompanying tweezers are placed adjacent to the epilator.

FIG. 9 is a front view thereof;

FIG. 10 is a right side view thereof; and

FIG. 11 is a rear view thereof.

FIG. 12 is a front perspective view of the epilator illustrating the new design, wherein the housing cap has been removed from the epilator head and positioned above the epilator, and the accompanying tweezers are placed adjacent to the epilator.

FIG. 13 is a rear perspective view thereof; and

FIG. 14 is a second perspective view thereof showing the upper portion of the epilator.

FIG. 15 is a front view of the epilator illustrating the new design, wherein the housing cap has been removed from the epilator head, and the accompanying tweezers are partly withdrawn from the epilator body; and

FIG. 16 is a right side view thereof; and,

FIG. 17 is a front perspective view of the epilator illustrating the new design, wherein the housing cap has been removed from the epilator head and positioned above the epilator, and the accompanying tweezers are partly withdrawn from the epilator body.

The housing cap has been removed in FIGS. 8-11, 15, and 16 for convenience of illustration.

The epilating head portion of the epilator is shown in broken lines for illustrative purposes only and forms no part of the claimed design.

1 Claim, 6 Drawing Sheets

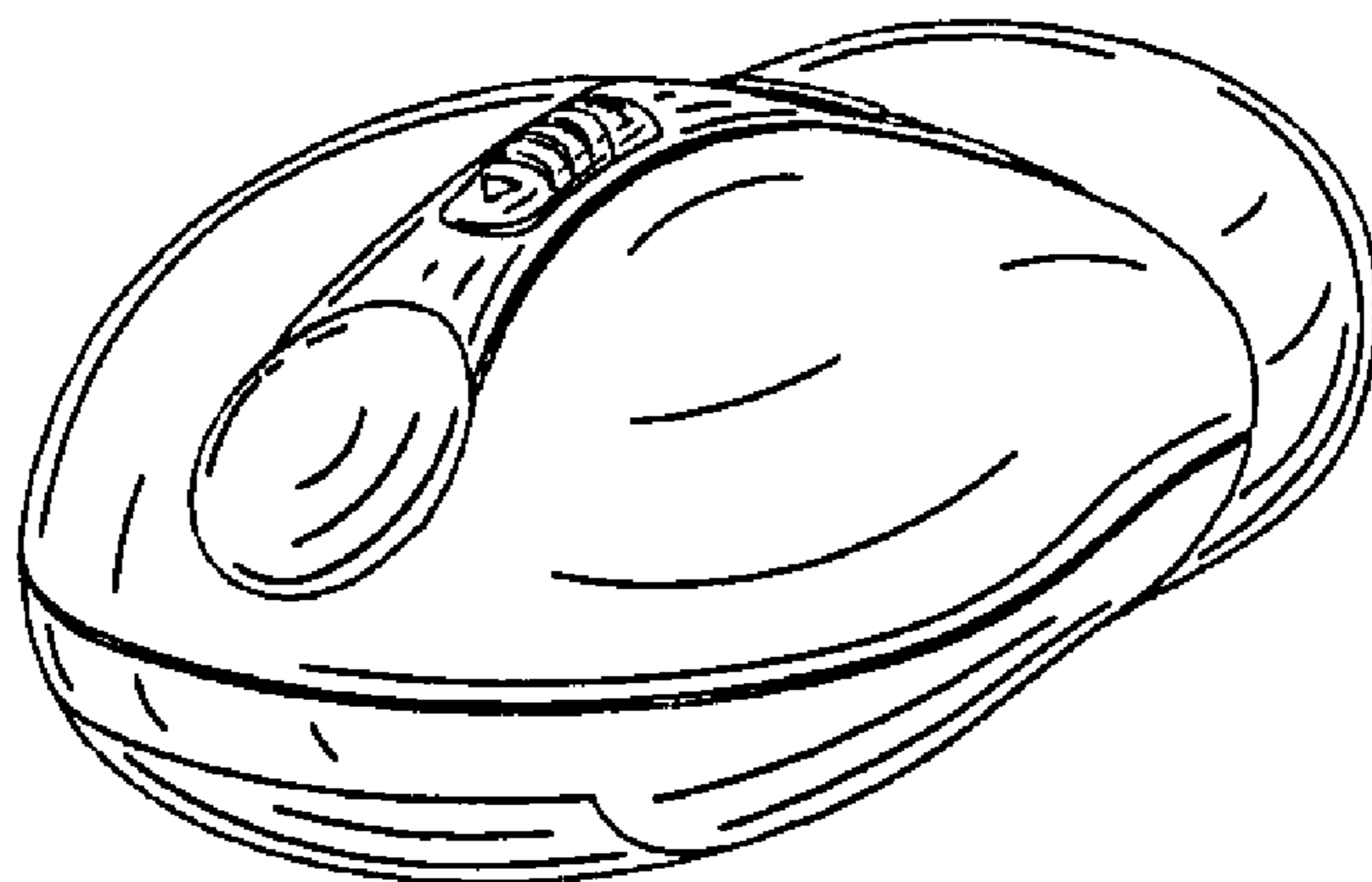

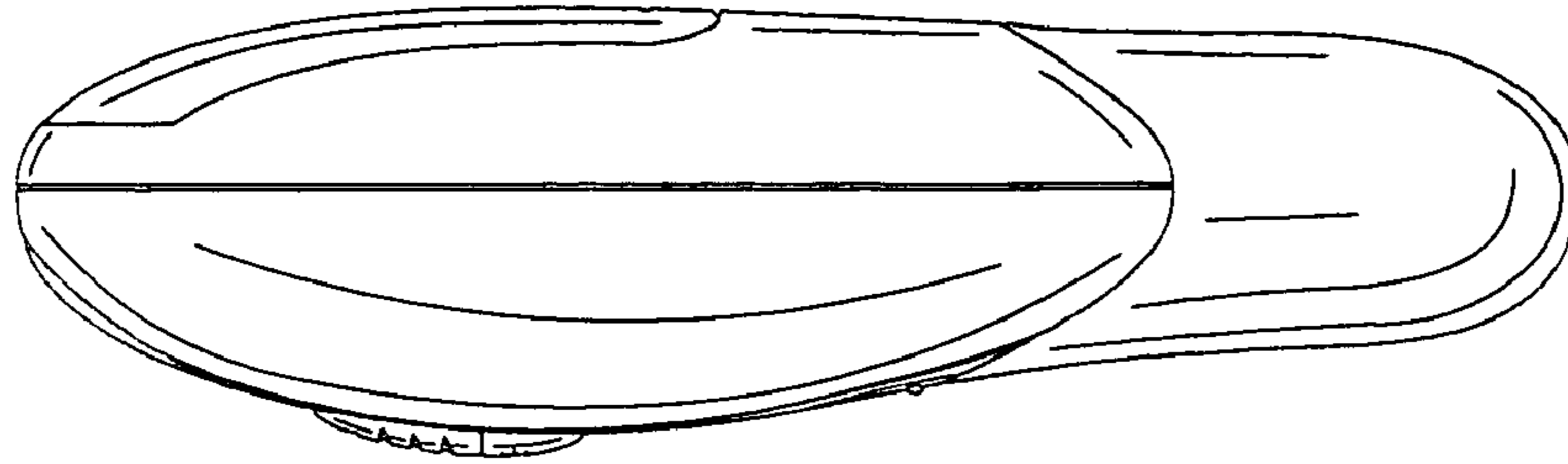

FIG. 1

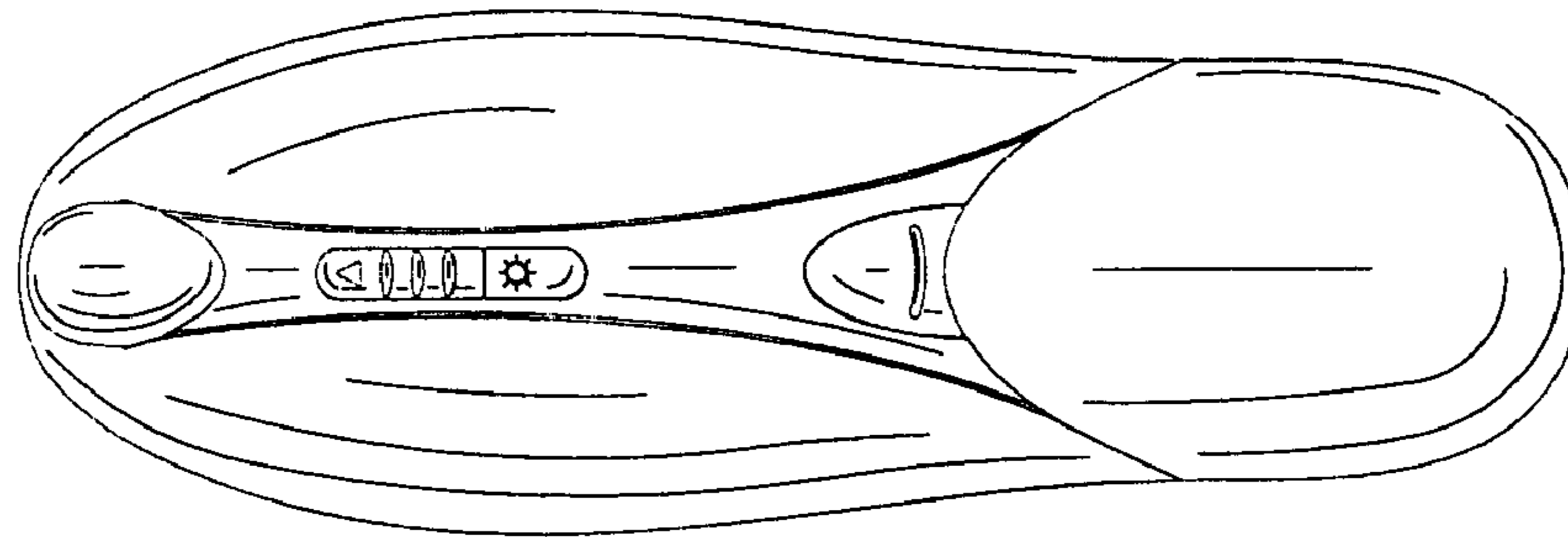

FIG. 2

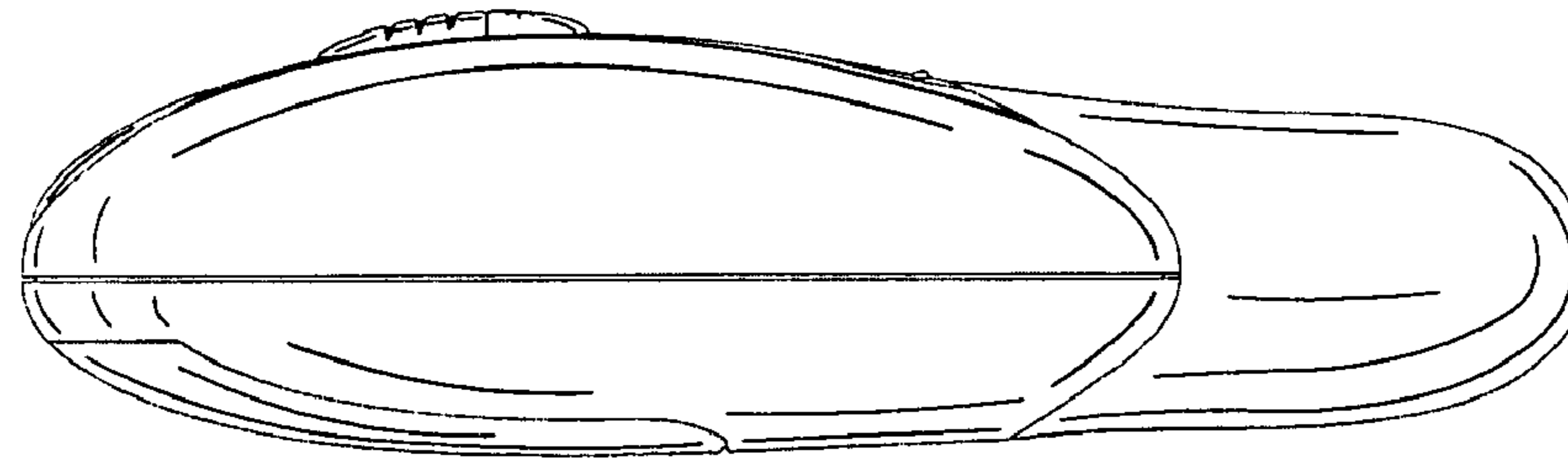

FIG. 3

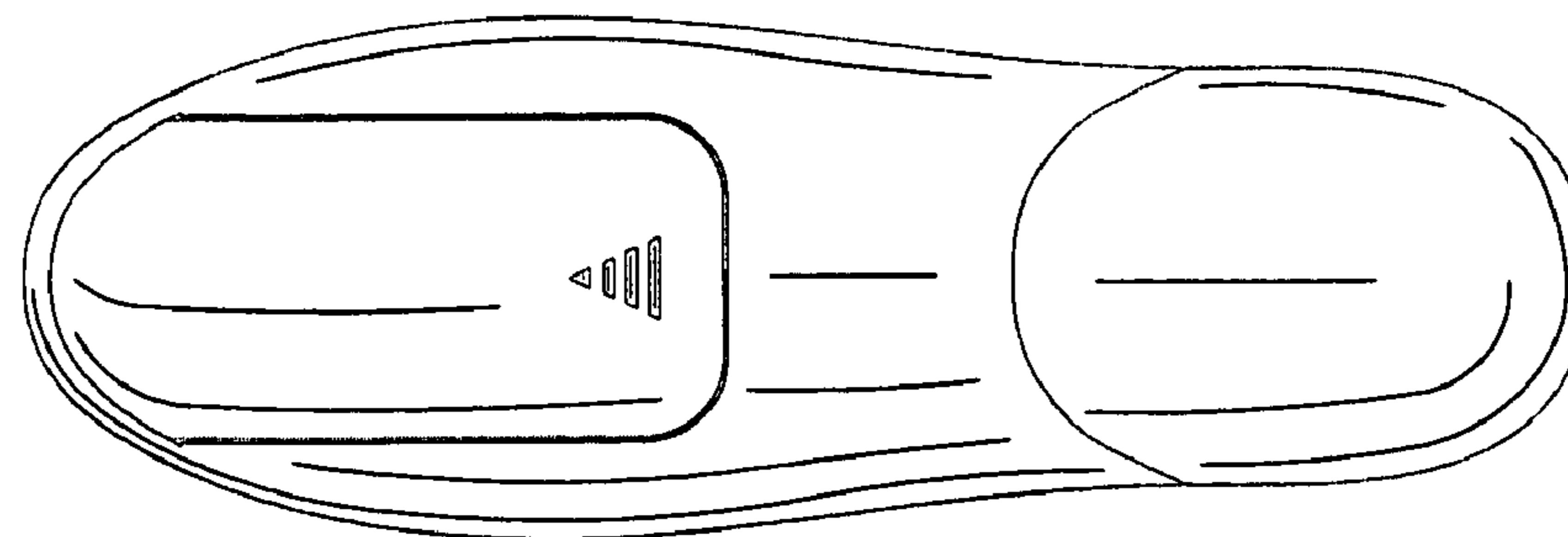

FIG. 4

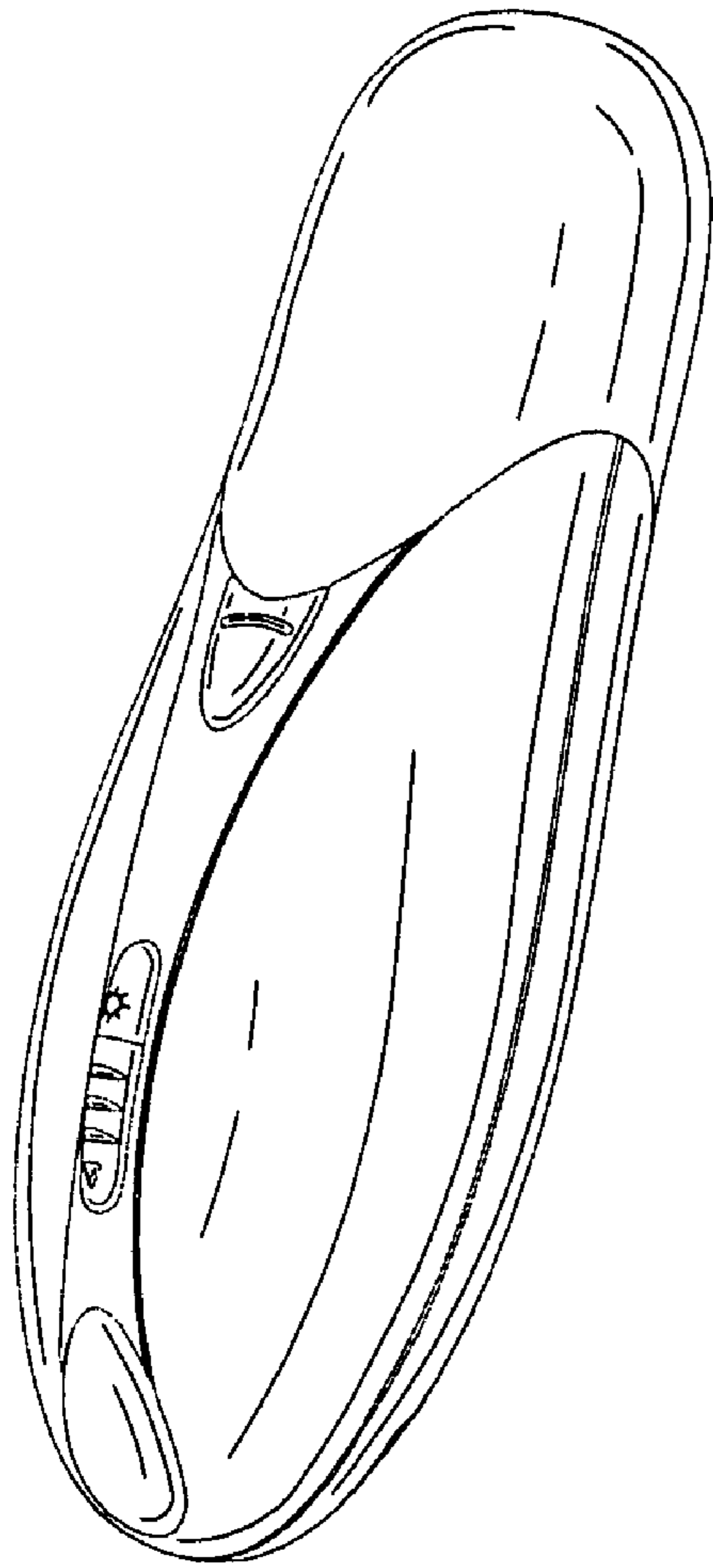

FIG. 5

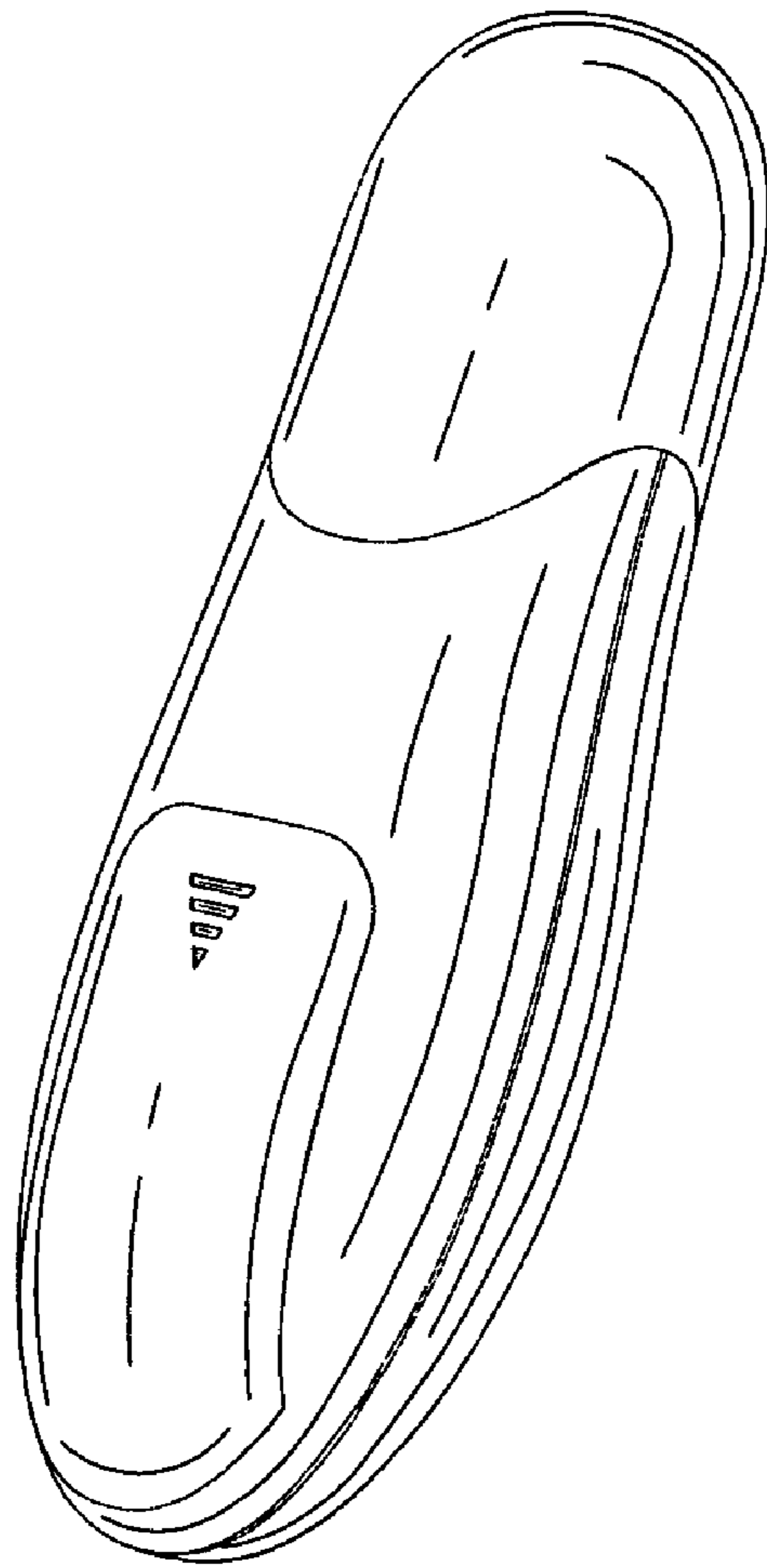

FIG. 6

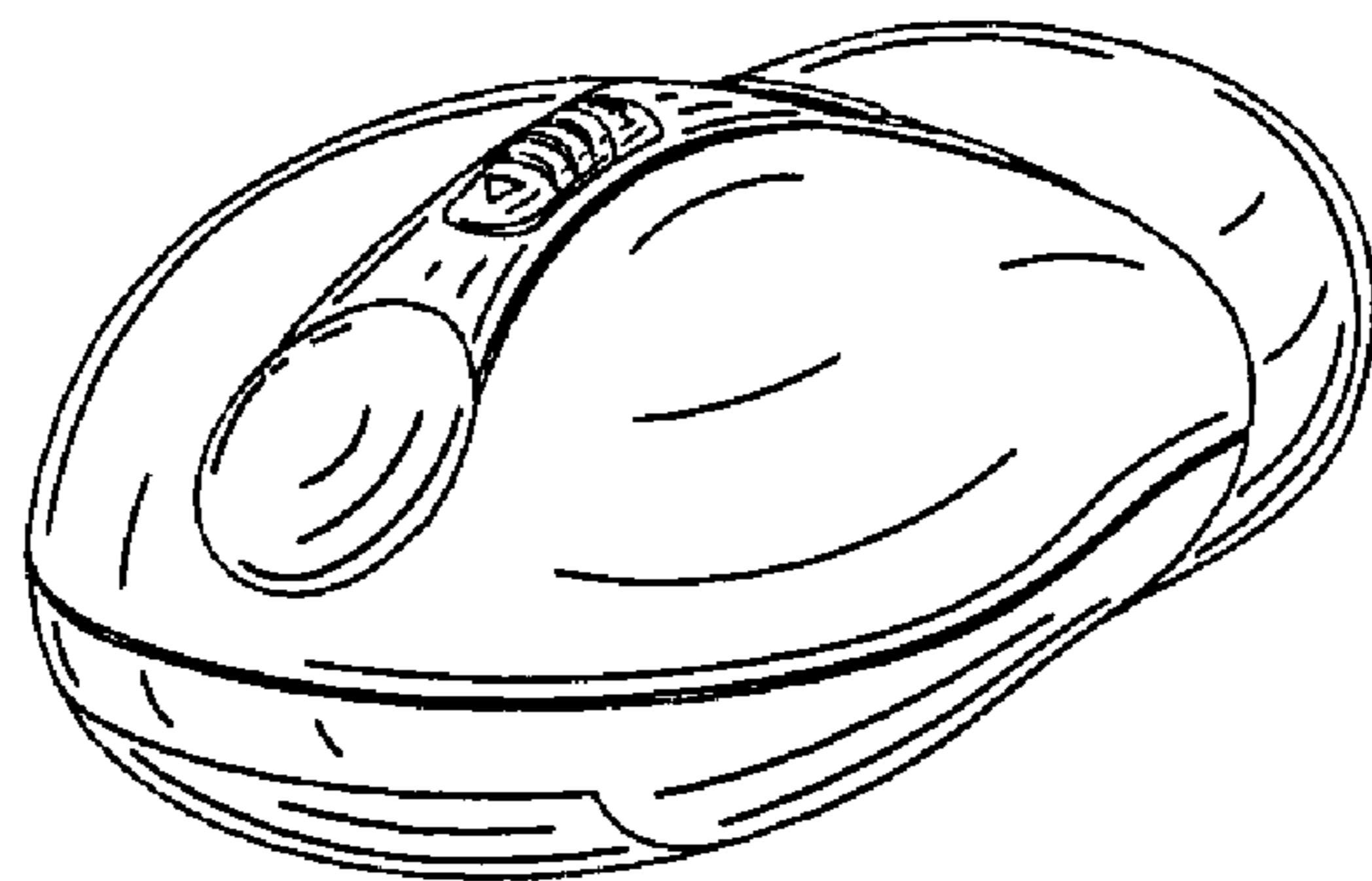

FIG. 7

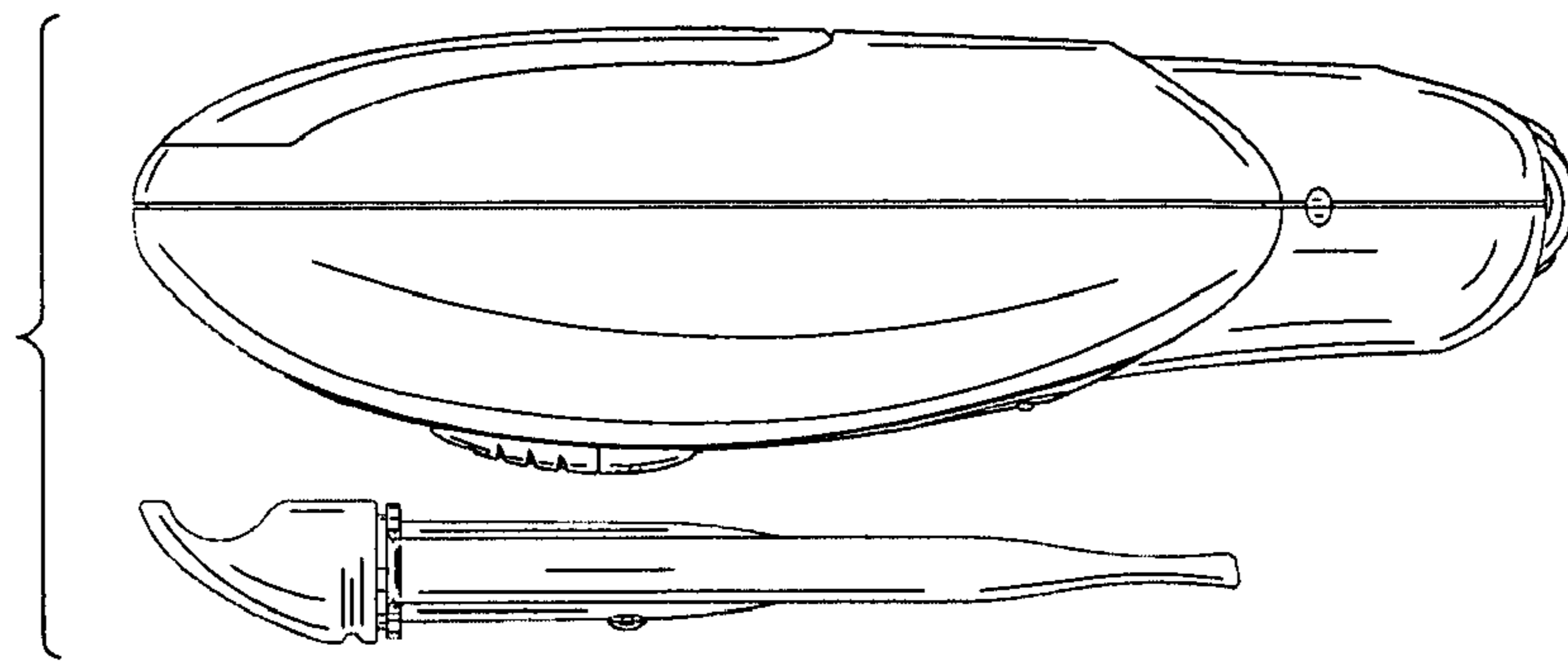

FIG. 8

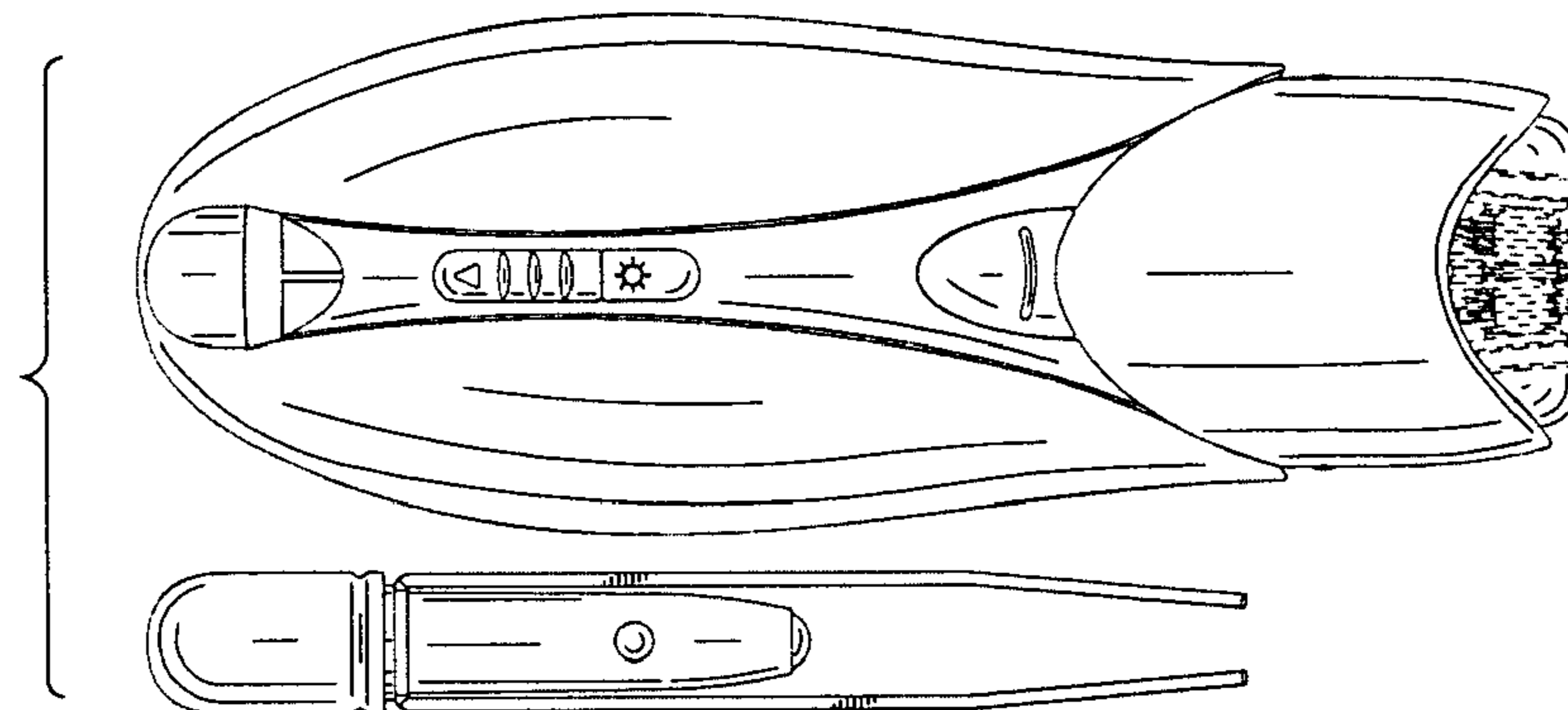

FIG. 9

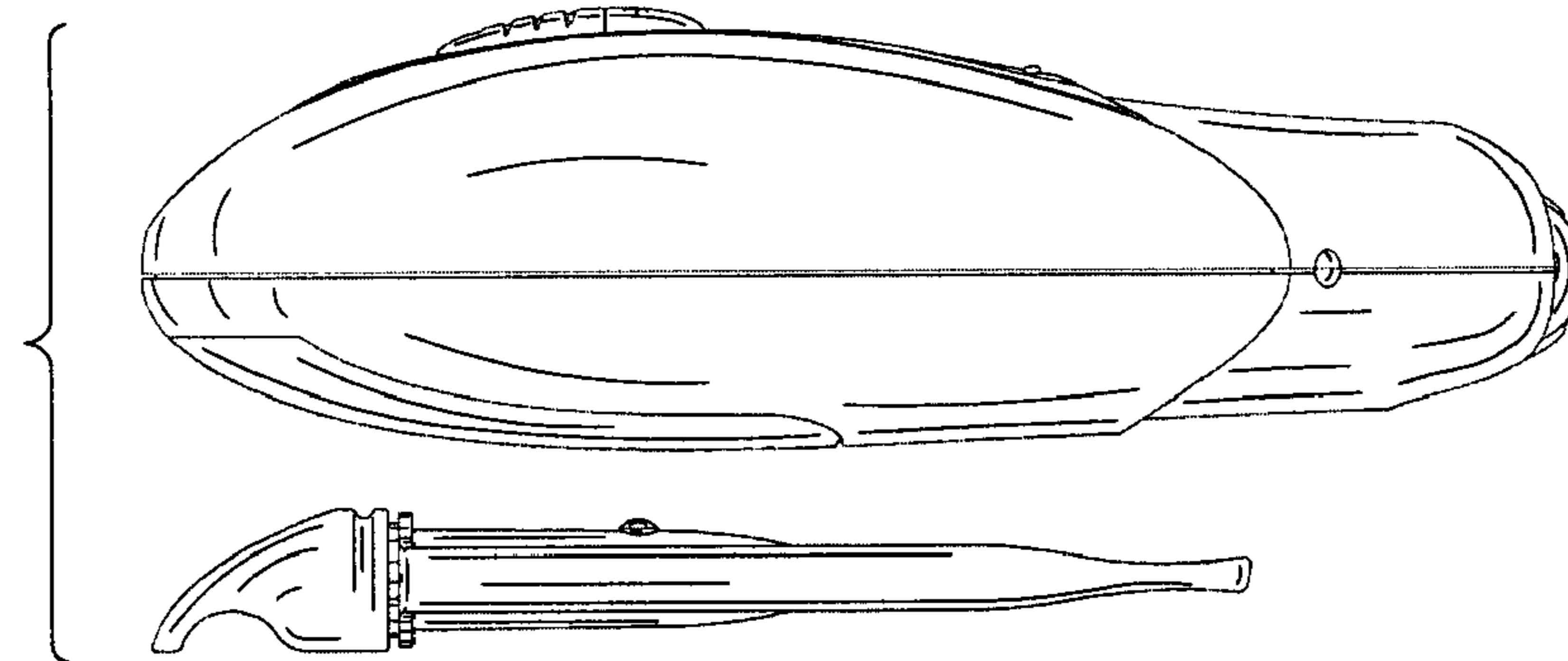

FIG. 10

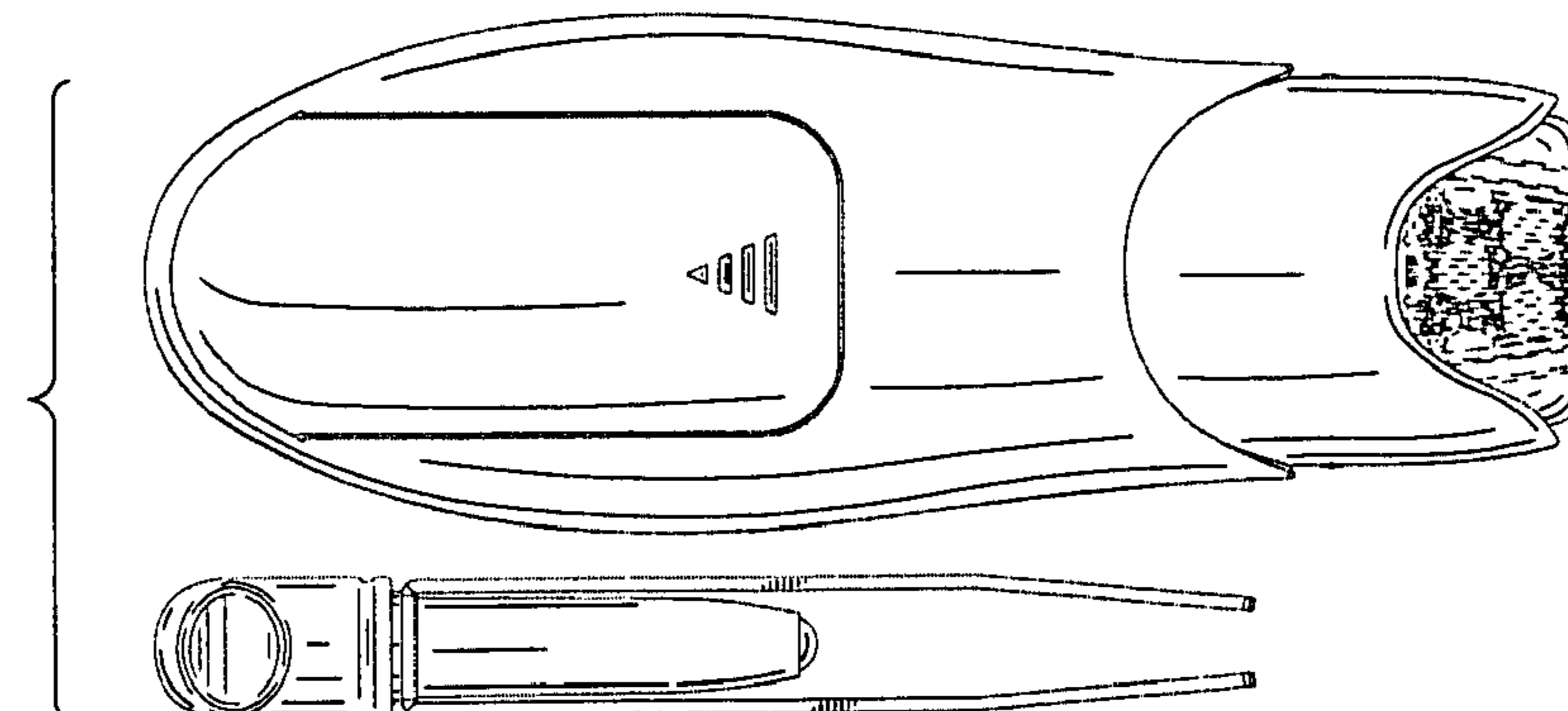

FIG. 11

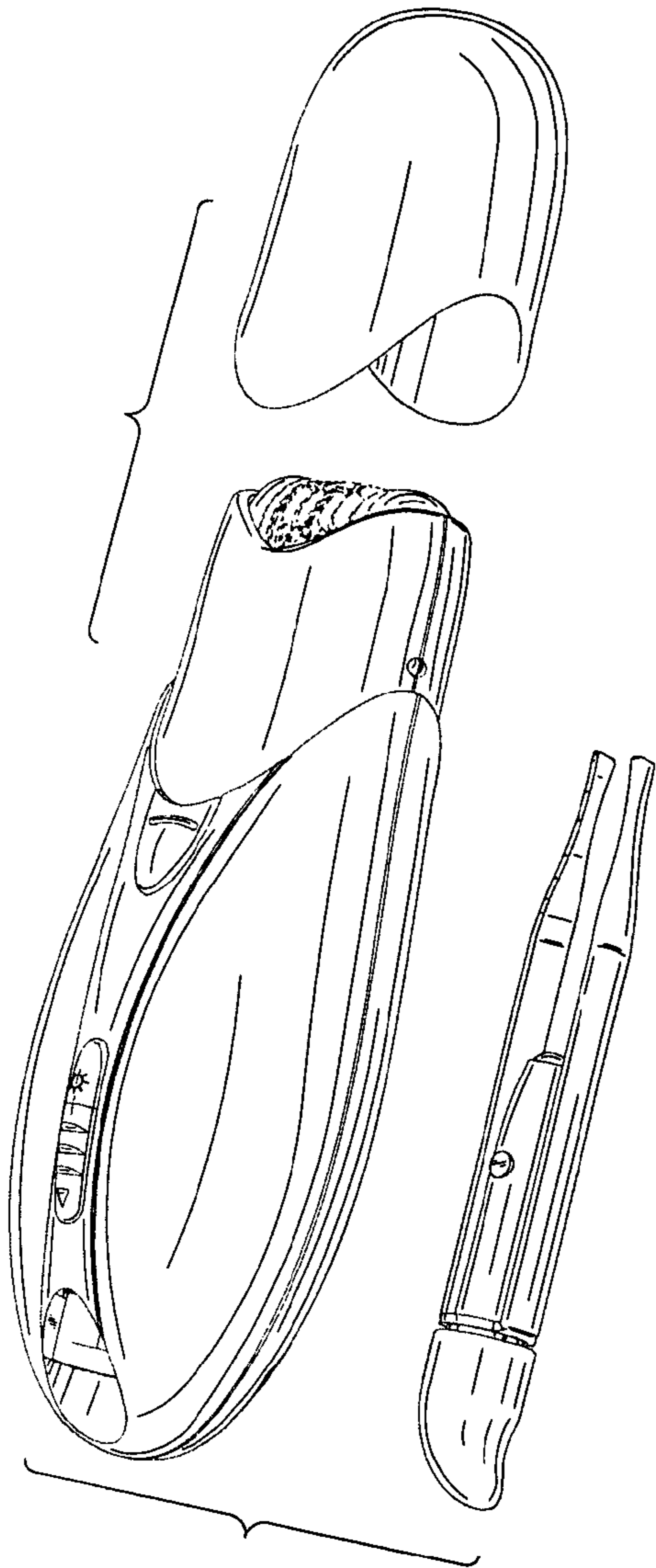

FIG. 12

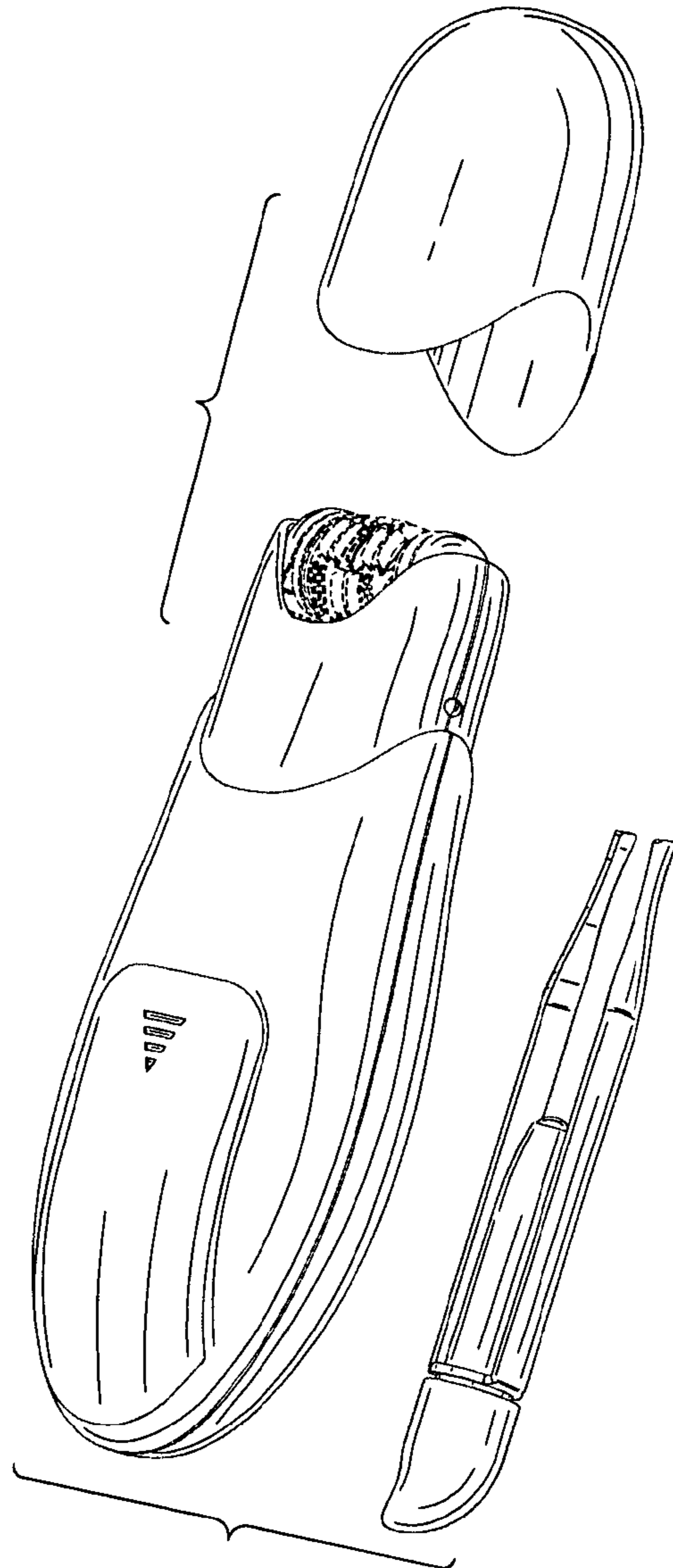

FIG. 13

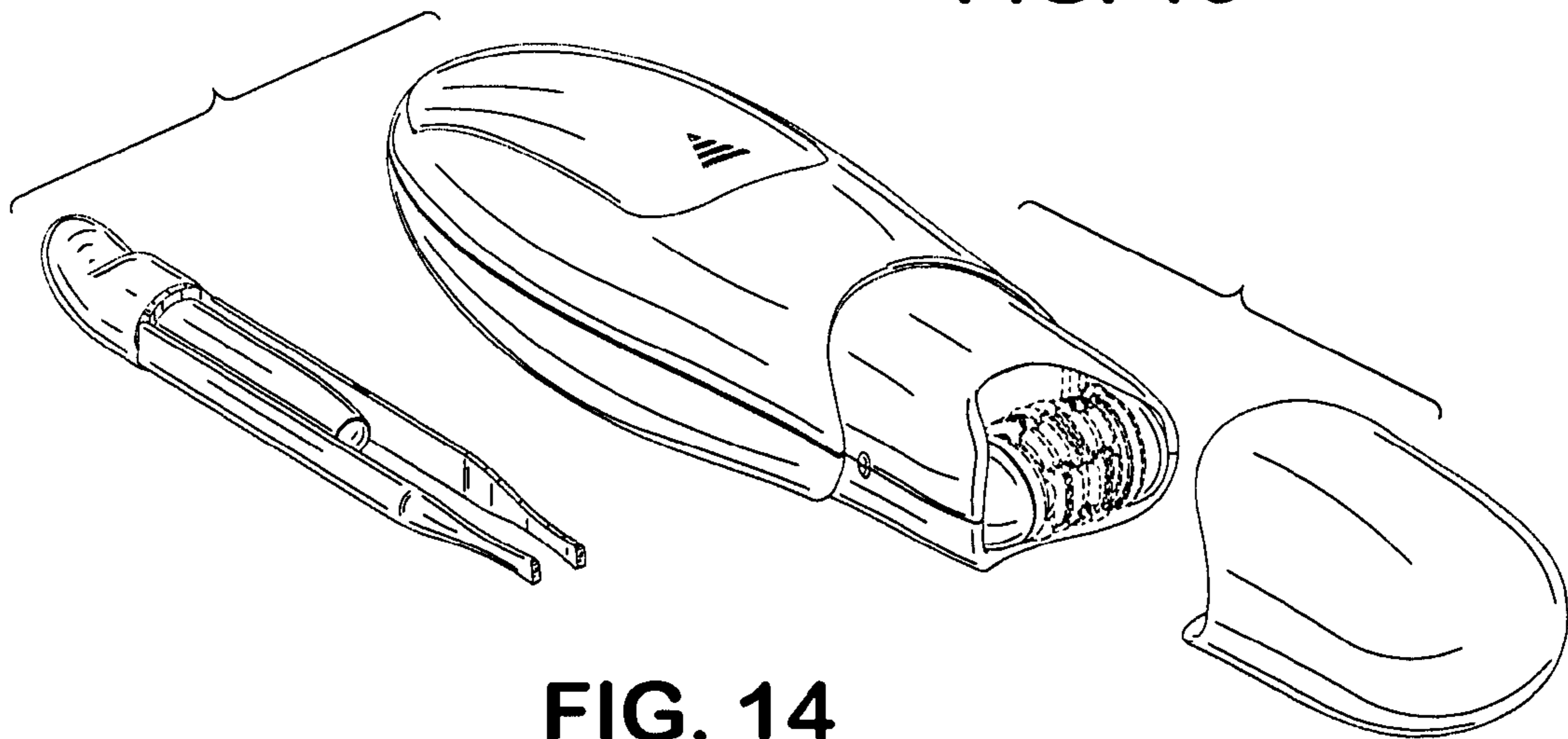

FIG. 14

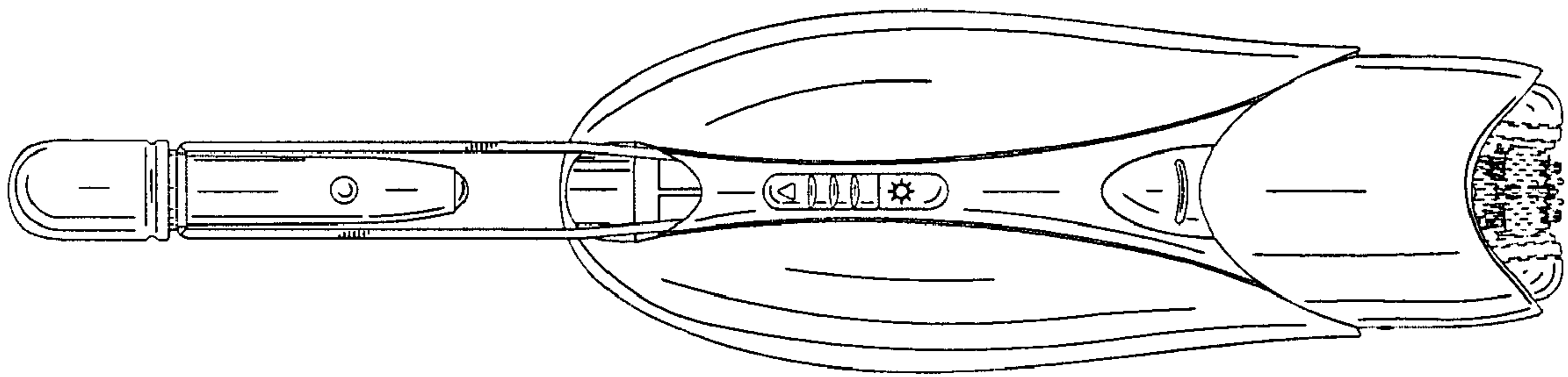

FIG. 15

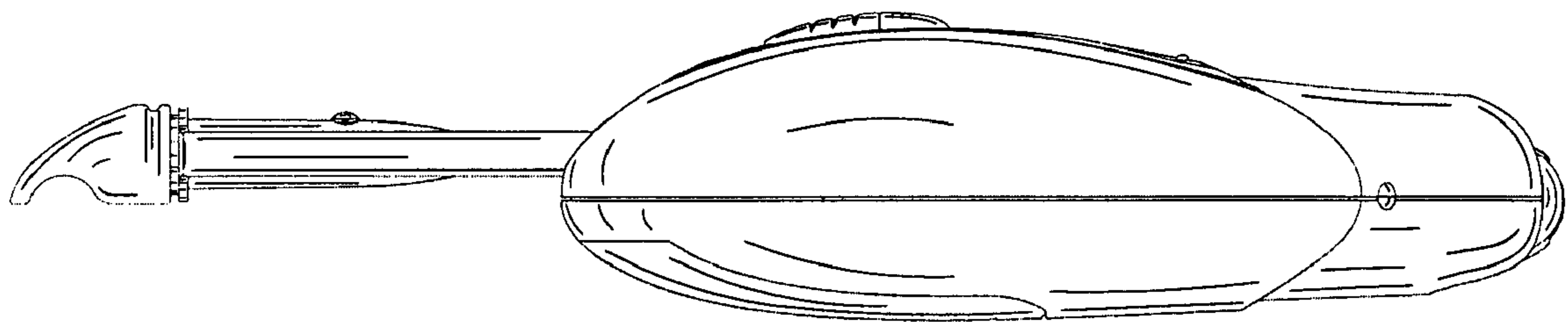

FIG. 16

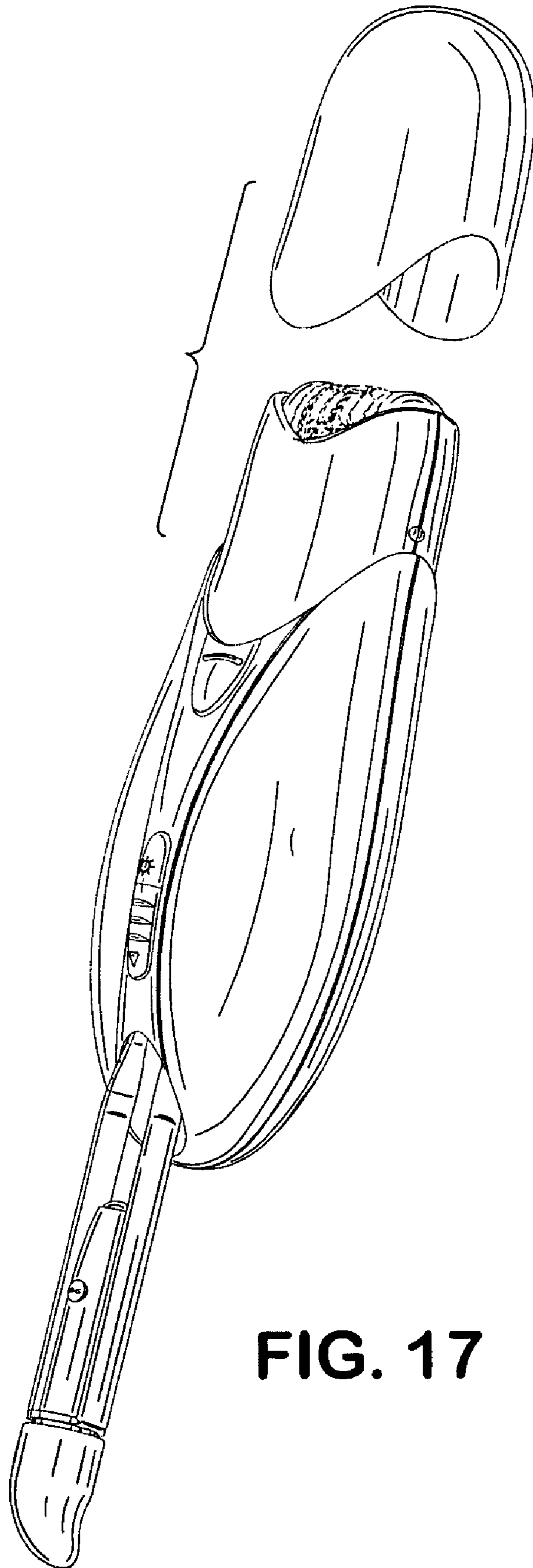

FIG. 17