

US00D598146S

(12) **United States Design Patent**
Amor et al.

(10) **Patent No.:** **US D598,146 S**

(45) **Date of Patent:** **** Aug. 11, 2009**

(54) **LIGHTING ASSEMBLY**

D581,069 S * 11/2008 Vanderhoek D26/28

* cited by examiner

(76) Inventors: **Grant Harold Amor**, Unit 4, 54 Siganto Drive, Helensvale QLD 4212 (AU); **Carl Denis Amor**, Unit 4, 54 Siganto Drive, Helensvale QLD 4212 (AU)

Primary Examiner—Marcus A. Jackson

(74) *Attorney, Agent, or Firm*—Schwegman, Lundberg & Woessner, P.A.

(**) Term: **14 Years**

(57) **CLAIM**

(21) Appl. No.: **29/323,324**

The ornamental design for a lighting assembly, as shown and described.

(22) Filed: **Aug. 22, 2008**

DESCRIPTION

(51) **LOC (9) Cl.** **26-06**

FIG. 1 is a front perspective view of a lighting assembly showing our new design;

(52) **U.S. Cl.** **D26/28**

FIG. 2 is a rear perspective view thereof;

(58) **Field of Classification Search** D26/28-36;
362/459-468, 475-478, 485-487

FIG. 3 is a front view thereof;

See application file for complete search history.

FIG. 4 is a rear view thereof;

(56) **References Cited**

U.S. PATENT DOCUMENTS

D564,110 S * 3/2008 Huang D26/31

D567,426 S * 4/2008 Chiu D26/85

D572,856 S * 7/2008 Kehl et al. D26/61

D578,685 S * 10/2008 Manus D26/28

FIG. 5 is a top plan view thereof;

FIG. 6 is a bottom view thereof;

FIG. 7 is a left side view thereof; and,

FIG. 8 is a right side view thereof.

1 Claim, 2 Drawing Sheets

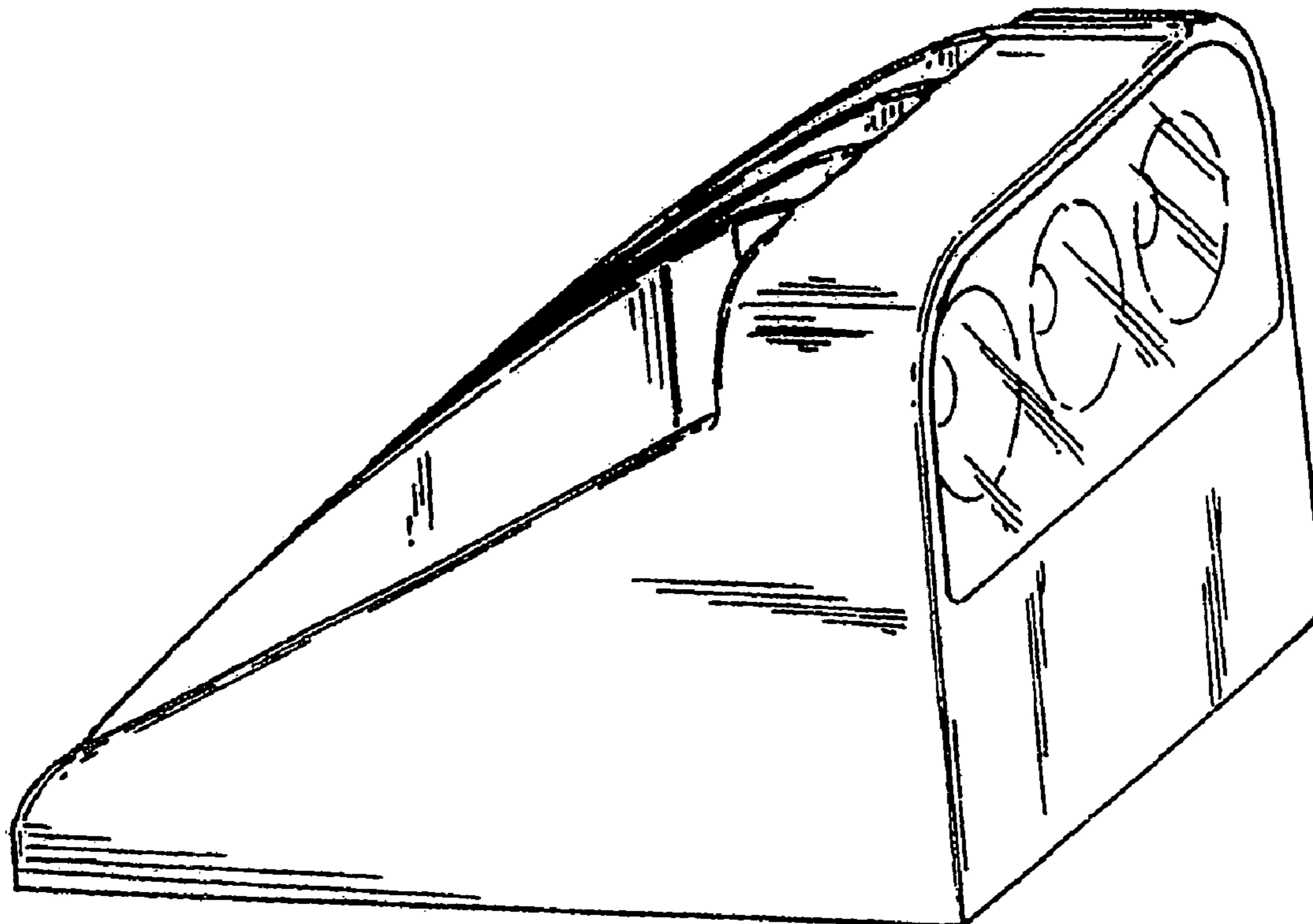

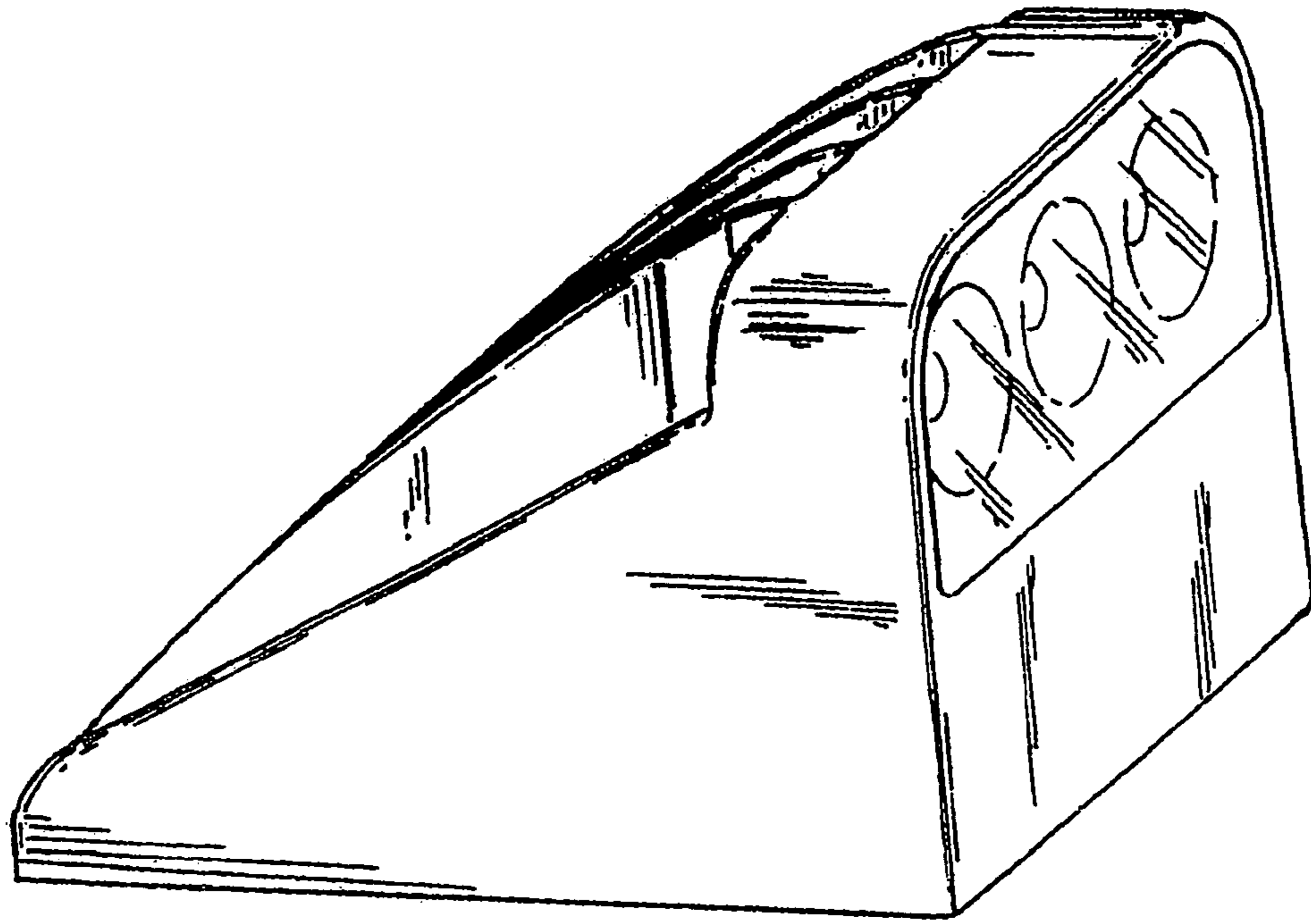

FIG. 1

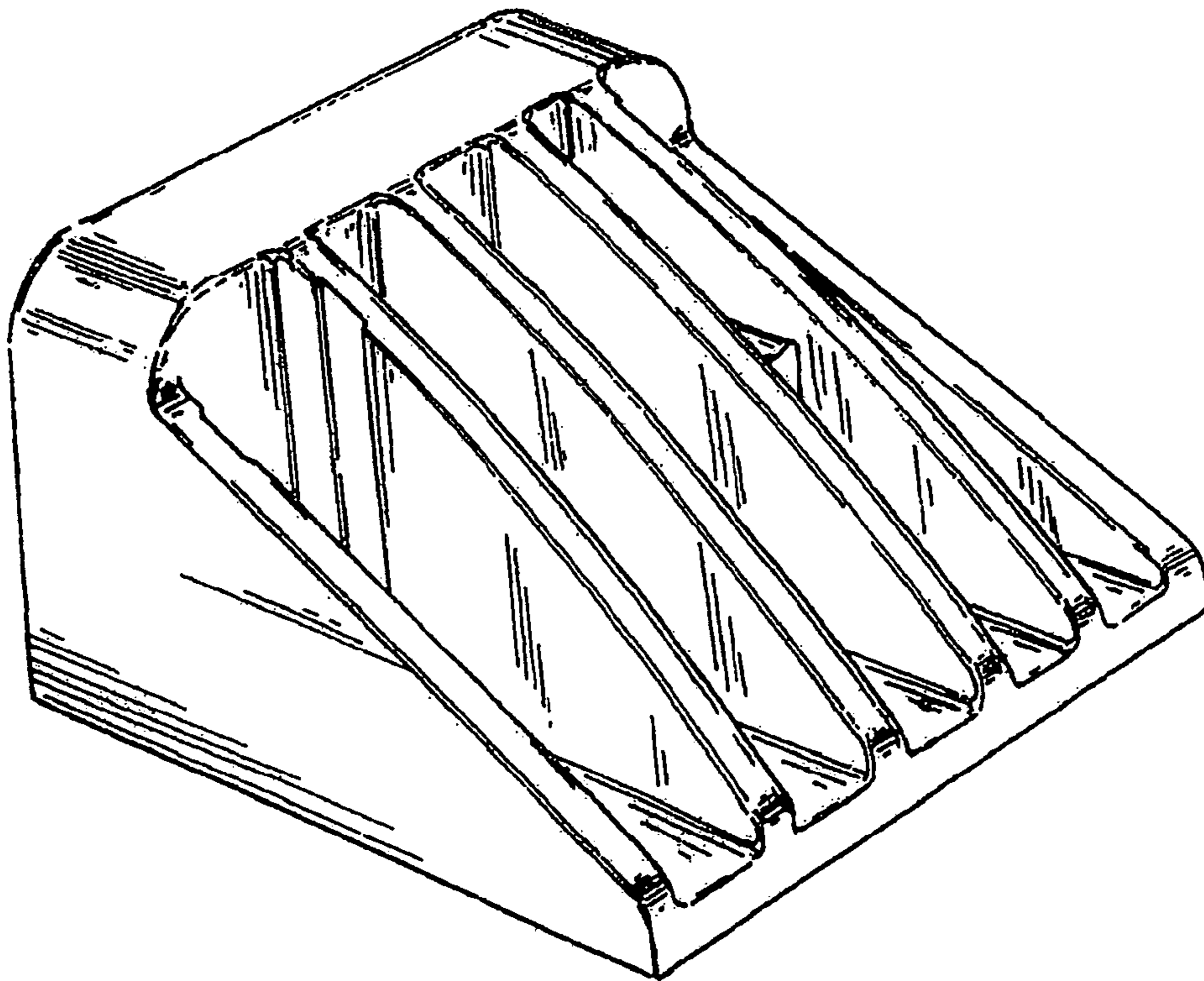

FIG. 2

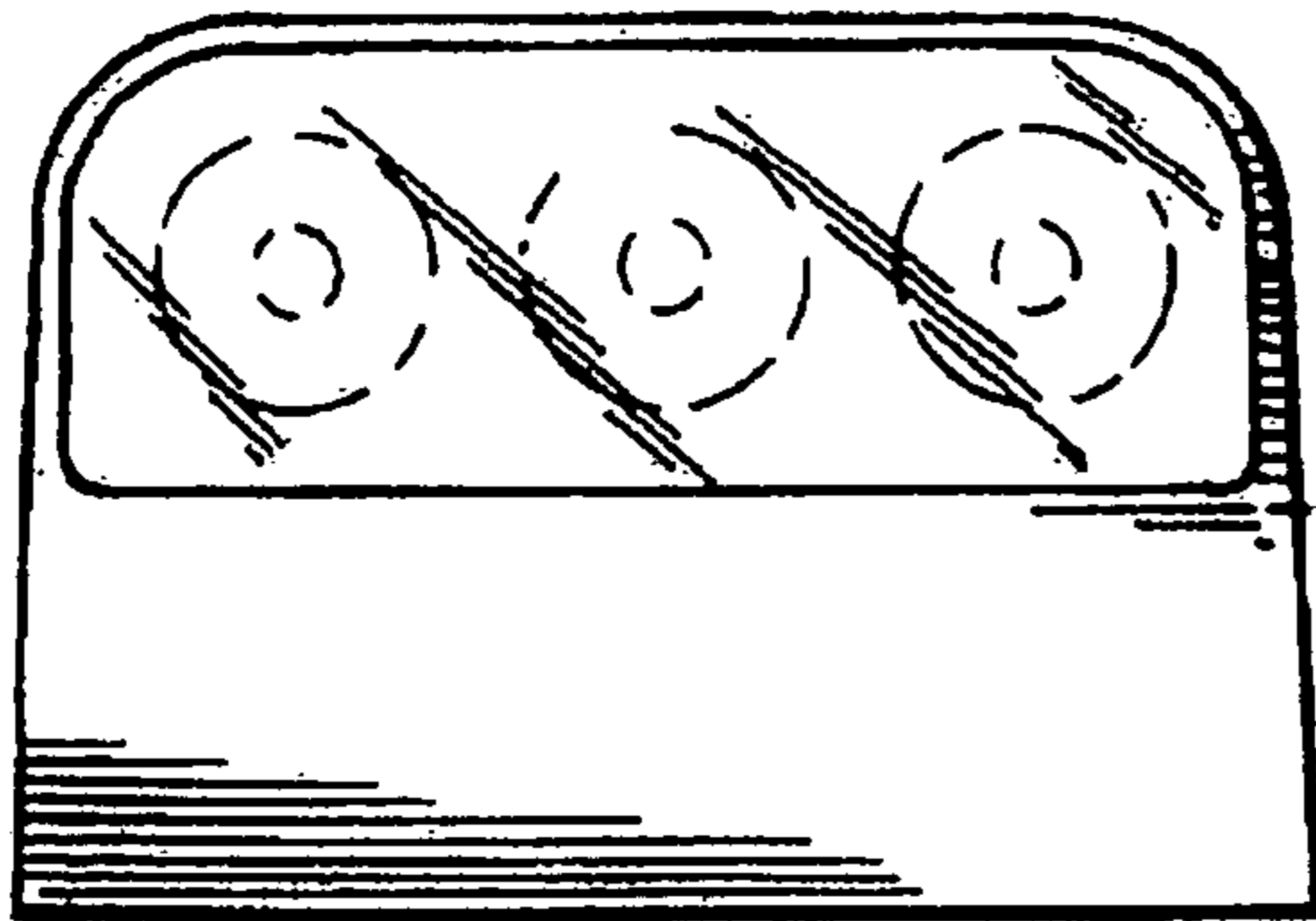

FIG. 3

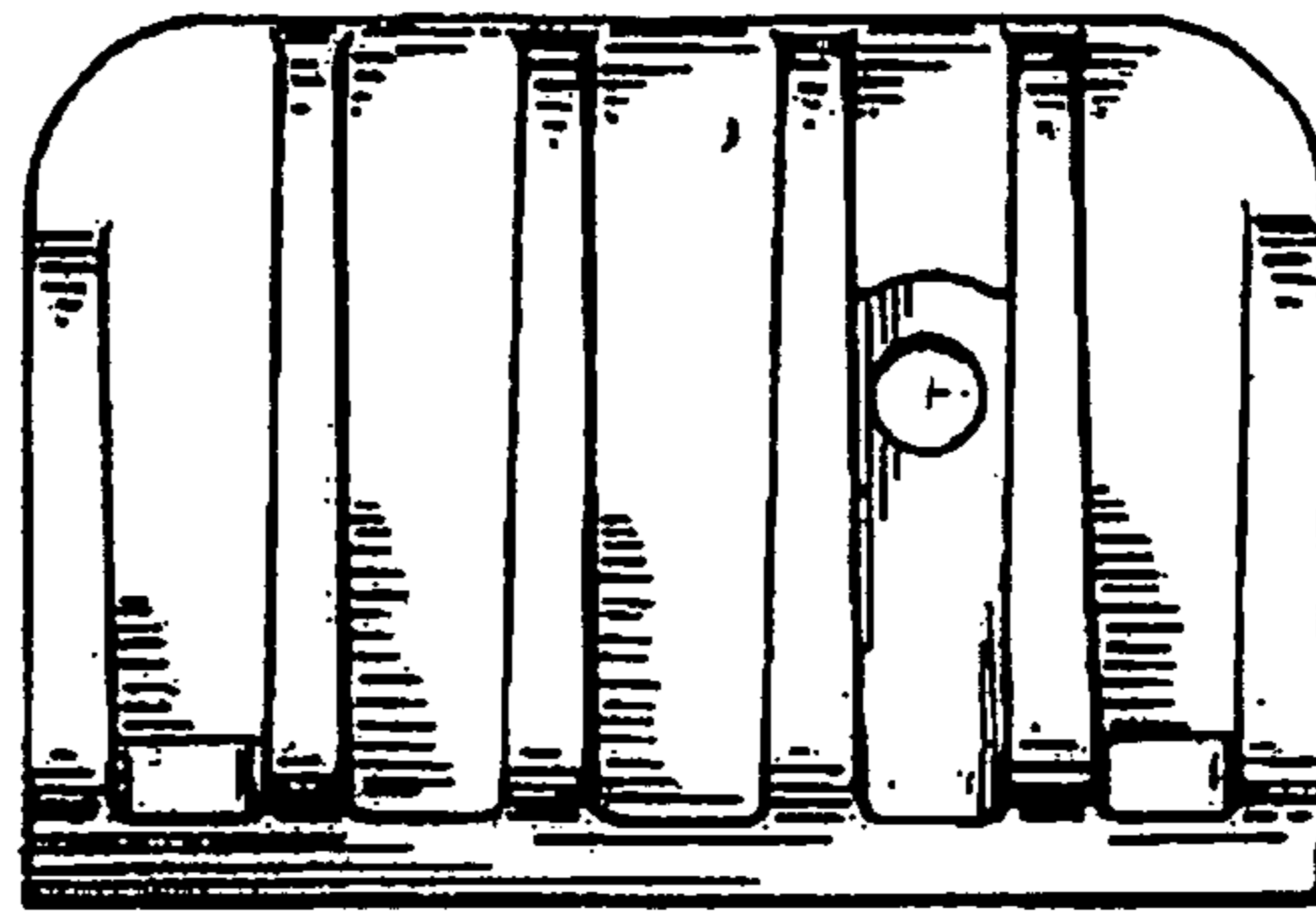

FIG. 4

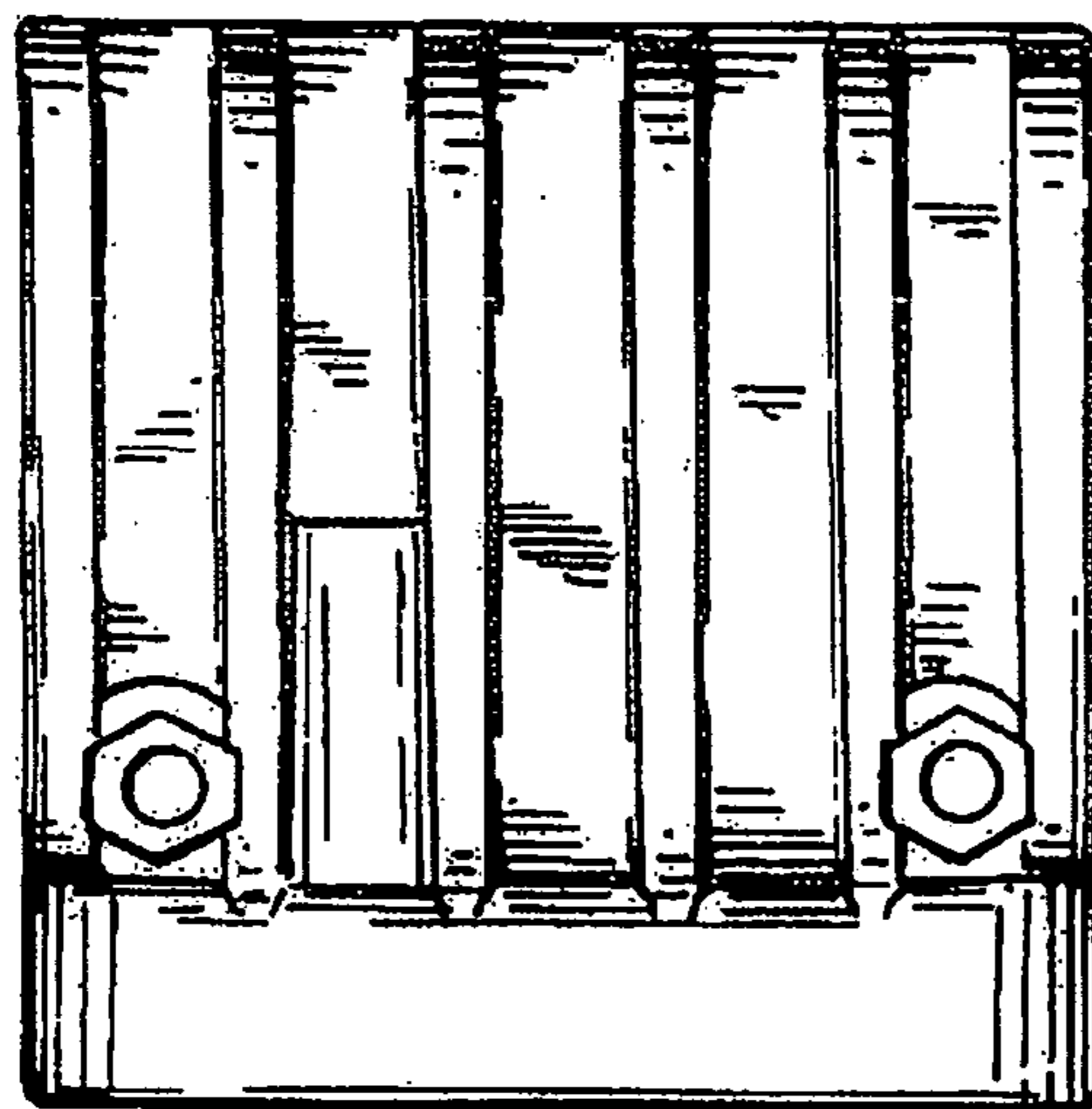

FIG. 5

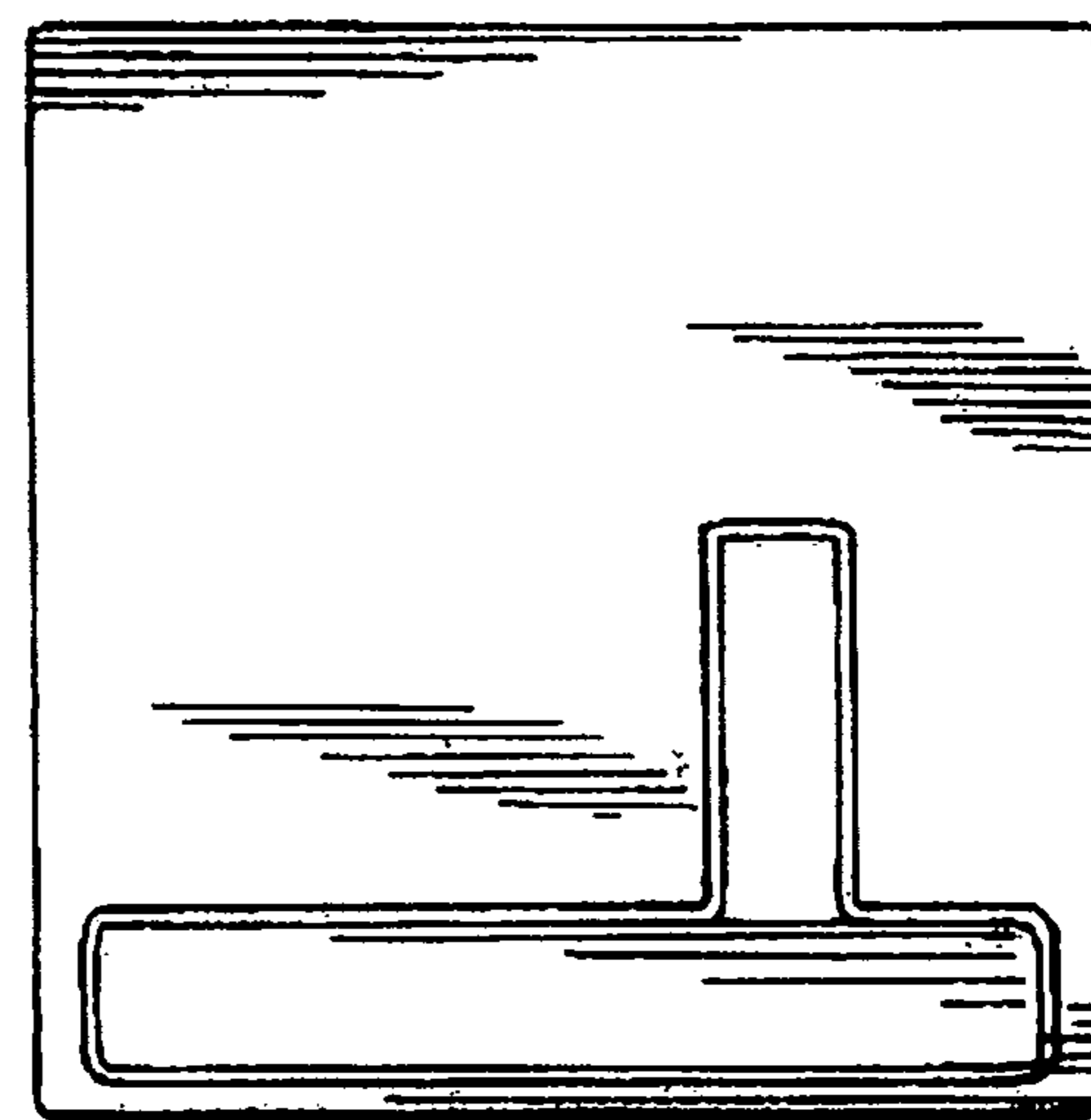

FIG. 6

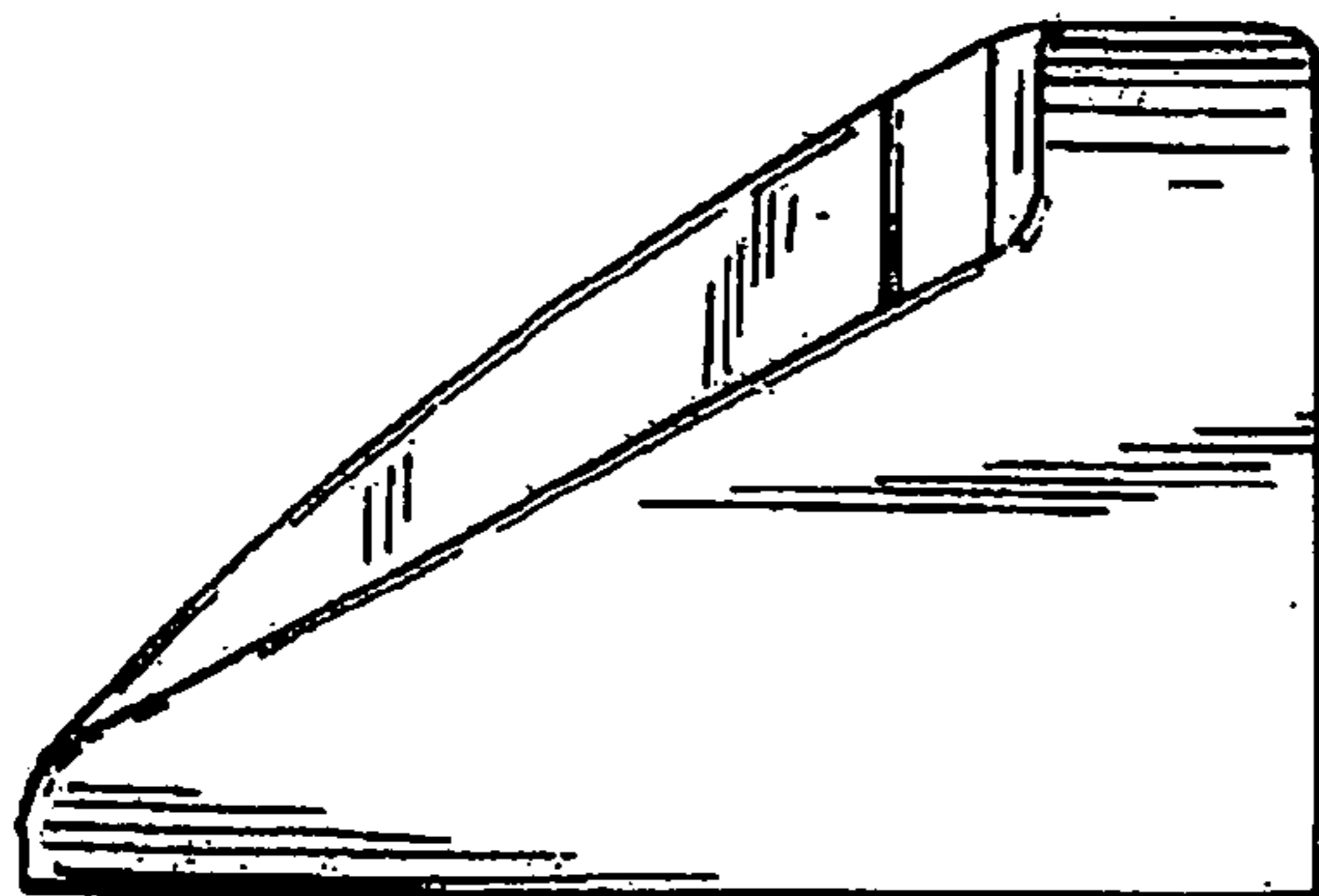

FIG. 7

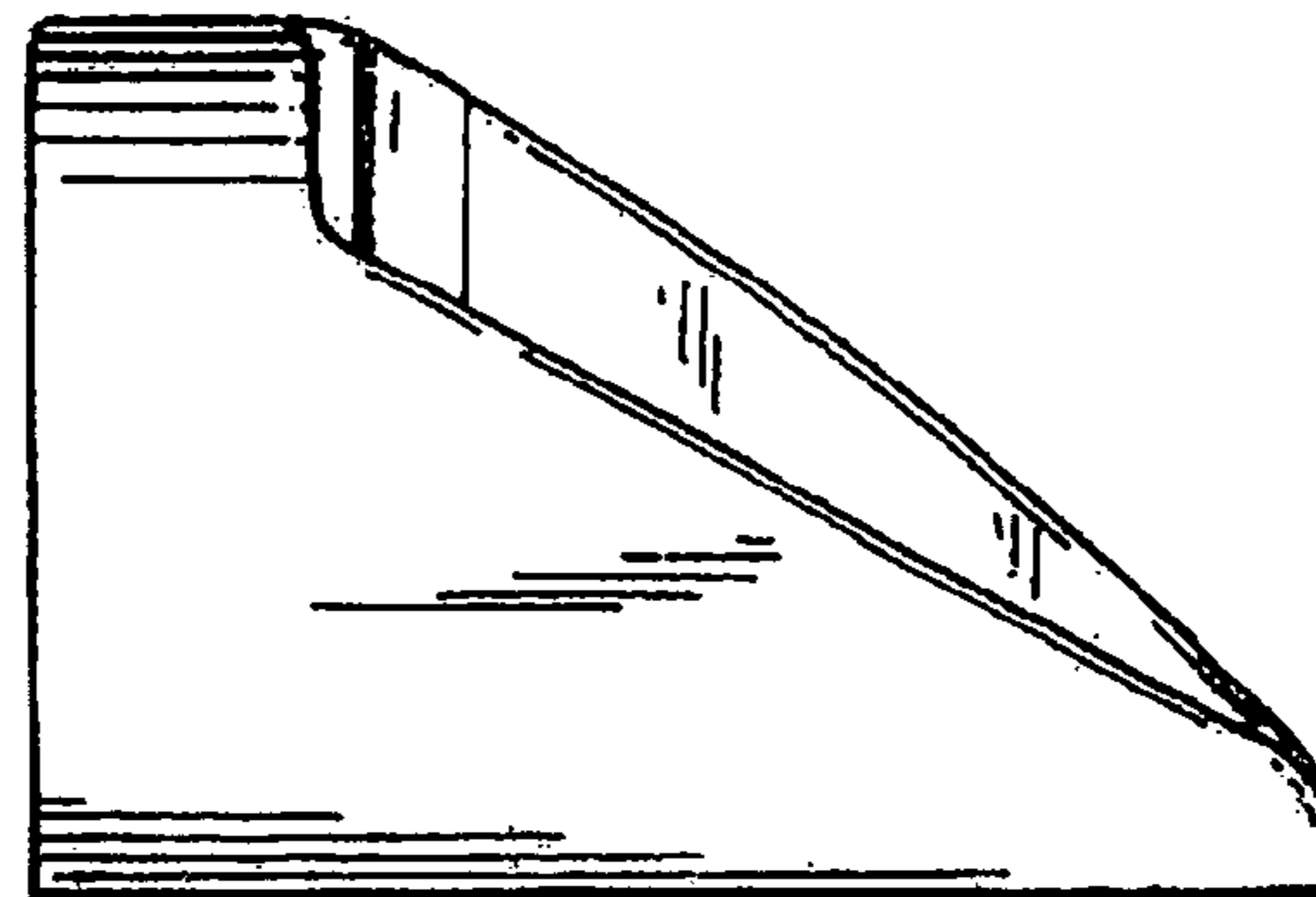

FIG. 8