

US00D598143S

(12) **United States Design Patent**
Gerritsen

(10) **Patent No.:** **US D598,143 S**

(45) **Date of Patent:** **** Aug. 11, 2009**

(54) **LAMP**

(75) Inventor: **Peter Gerritsen**, Eindhoven (NL)

(73) Assignee: **Koninklijke Philips Electronics N.V.**,
Eindhoven (NL)

(**) Term: **14 Years**

(21) Appl. No.: **29/332,495**

(22) Filed: **Feb. 18, 2009**

(51) **LOC (9) Cl.** **26-04**

(52) **U.S. Cl.** **D26/2**

(58) **Field of Classification Search** D26/1-4;
313/313, 315, 316, 317, 318, 493; 315/52,
315/53, 56, 57, 58

See application file for complete search history.

(56) **References Cited**

U.S. PATENT DOCUMENTS

D535,038 S * 1/2007 Egawa et al. D26/2

D541,440 S * 4/2007 Feit D26/2
D553,267 S * 10/2007 Yuen D26/2
D582,577 S * 12/2008 Yuen D26/2
D584,838 S * 1/2009 To et al. D26/2

* cited by examiner

Primary Examiner—Marcus A. Jackson

(57) **CLAIM**

The ornamental design for a lamp, as shown.

DESCRIPTION

FIG. 1 is a perspective view showing my design;
FIG. 2 is a front elevational view thereof;
FIG. 3 is a rear elevational view thereof;
FIG. 4 is a right side elevational view thereof;
FIG. 5 is a left side elevational view thereof;
FIG. 6 is a top plan view thereof; and,
FIG. 7 is a bottom plan view thereof.

1 Claim, 3 Drawing Sheets

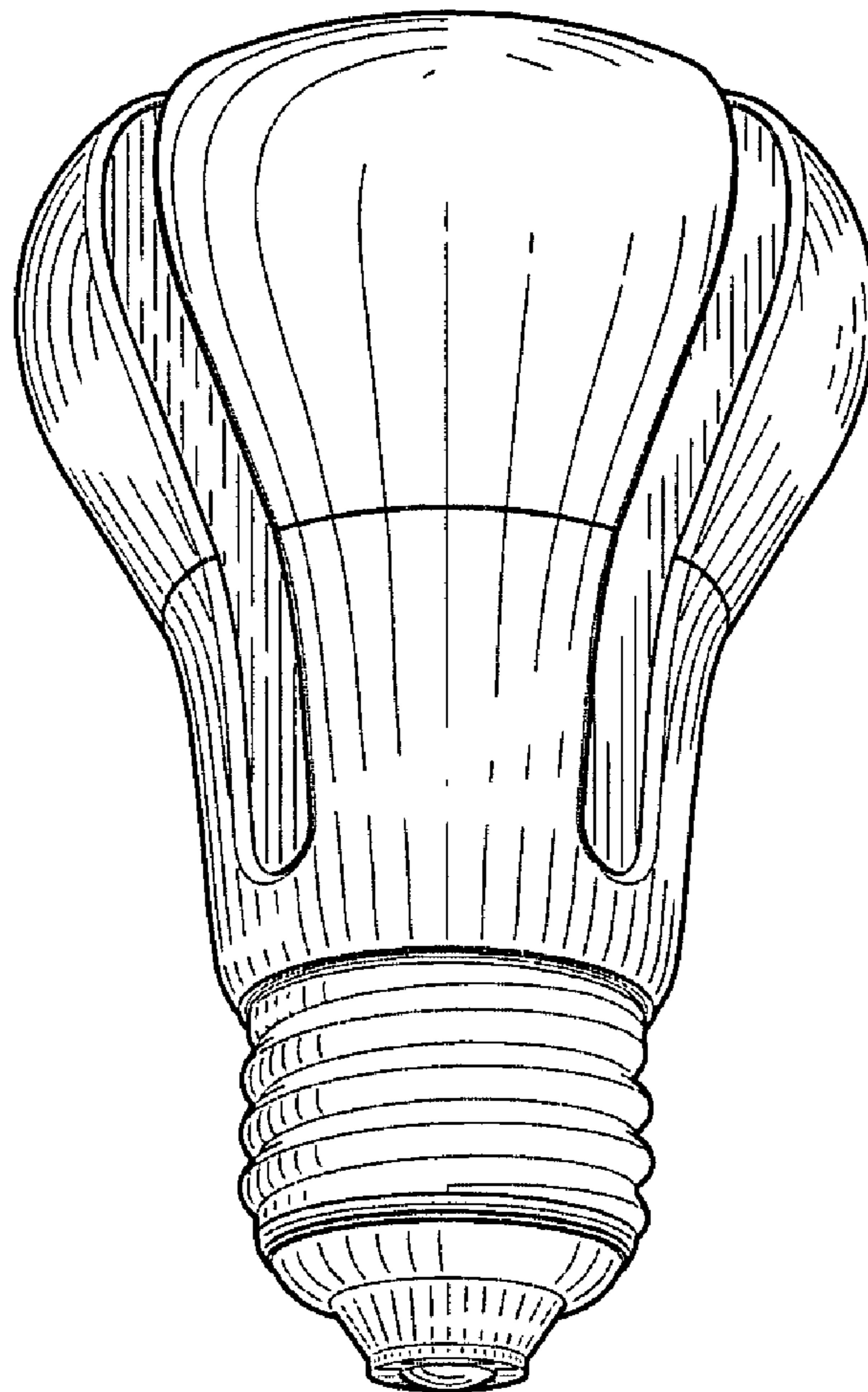

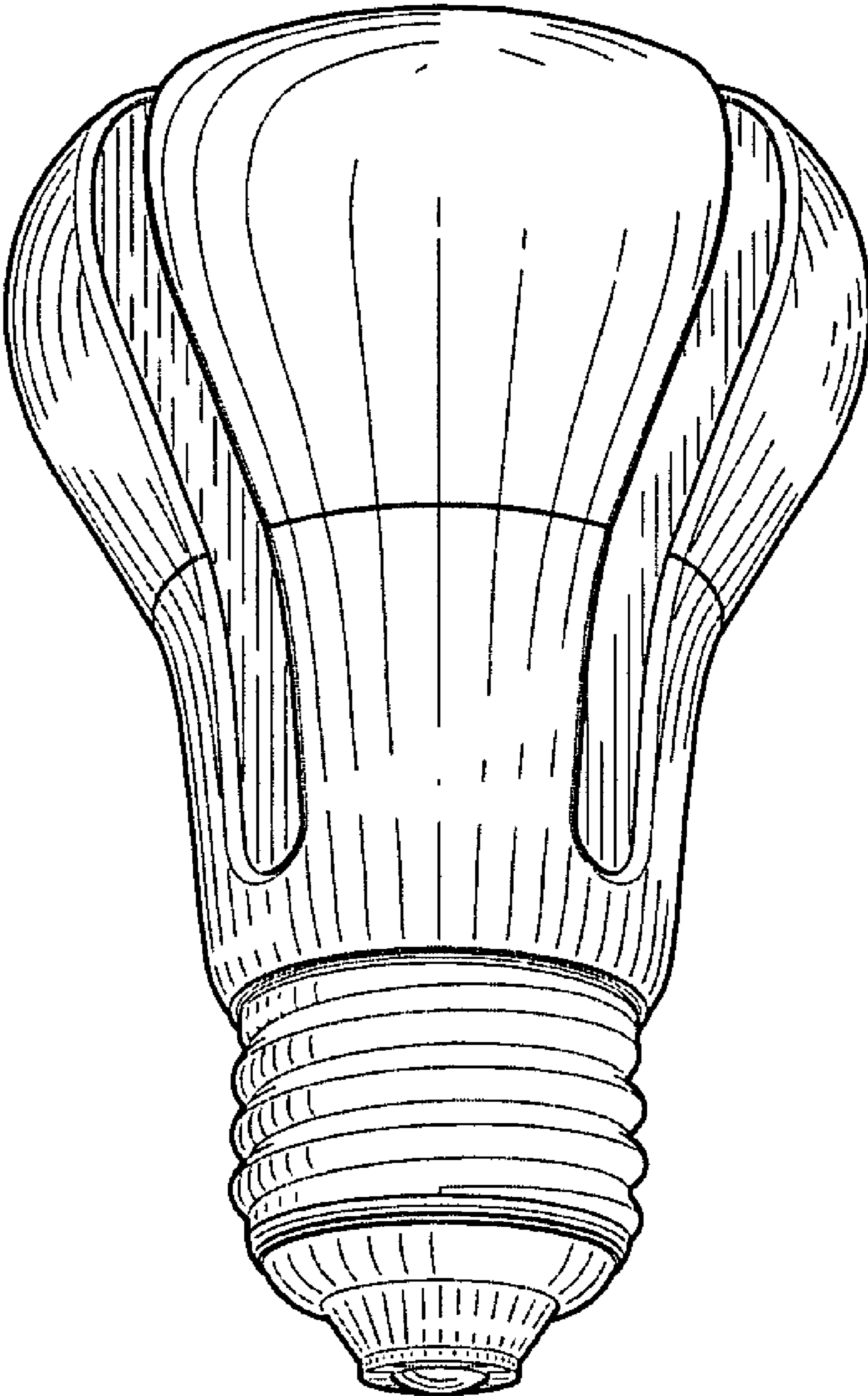

FIG. 1

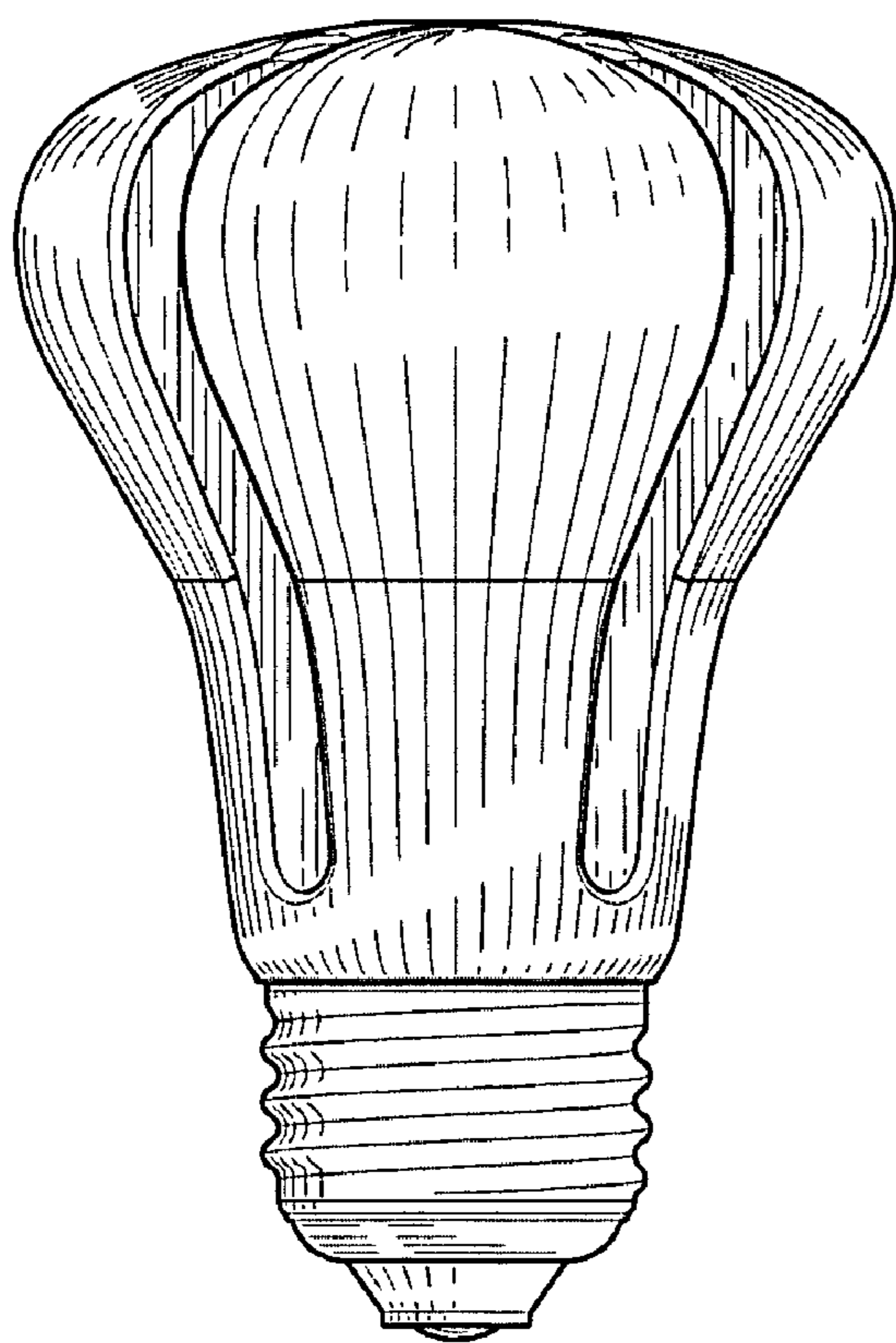

FIG. 2

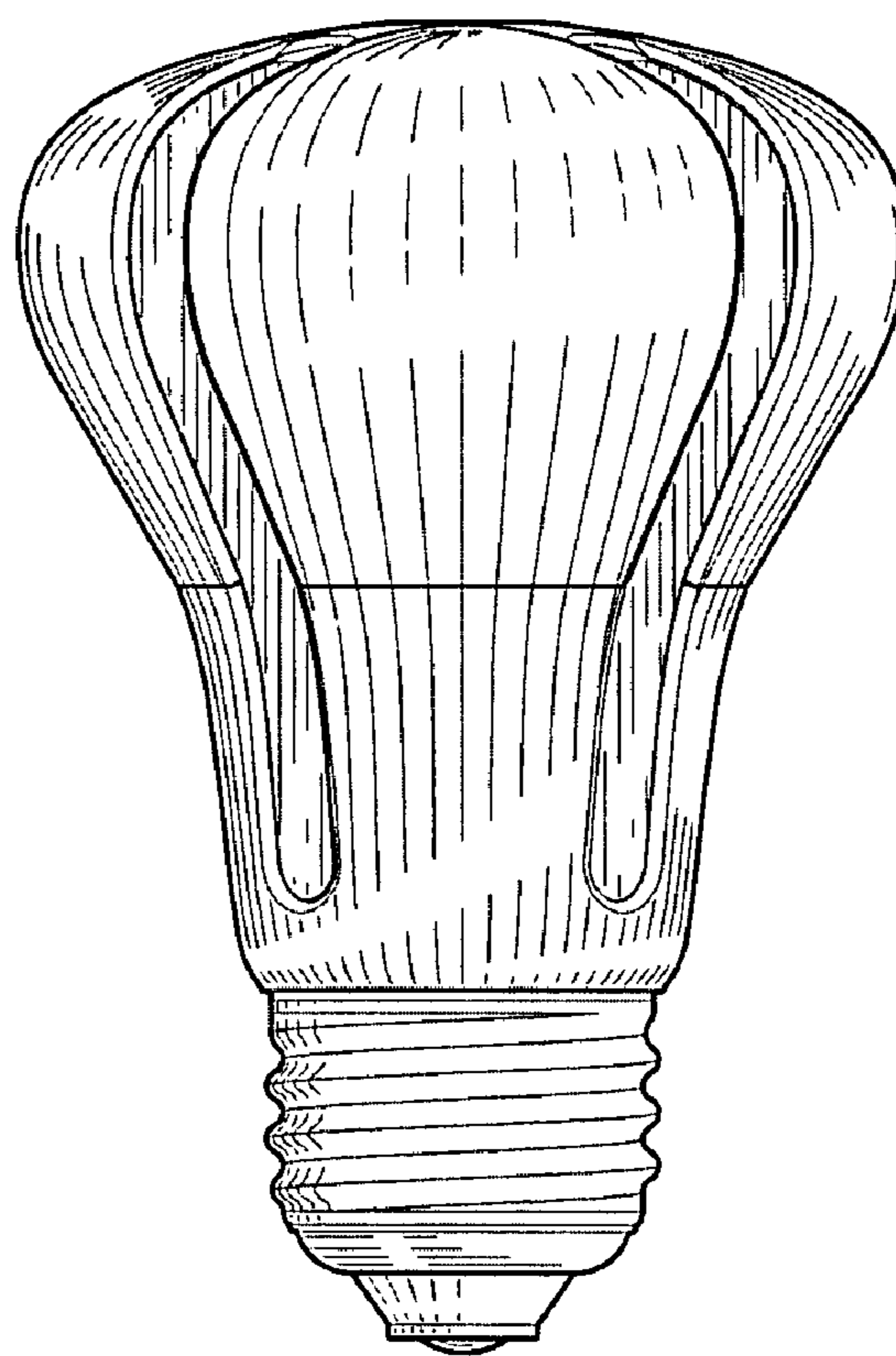

FIG. 3

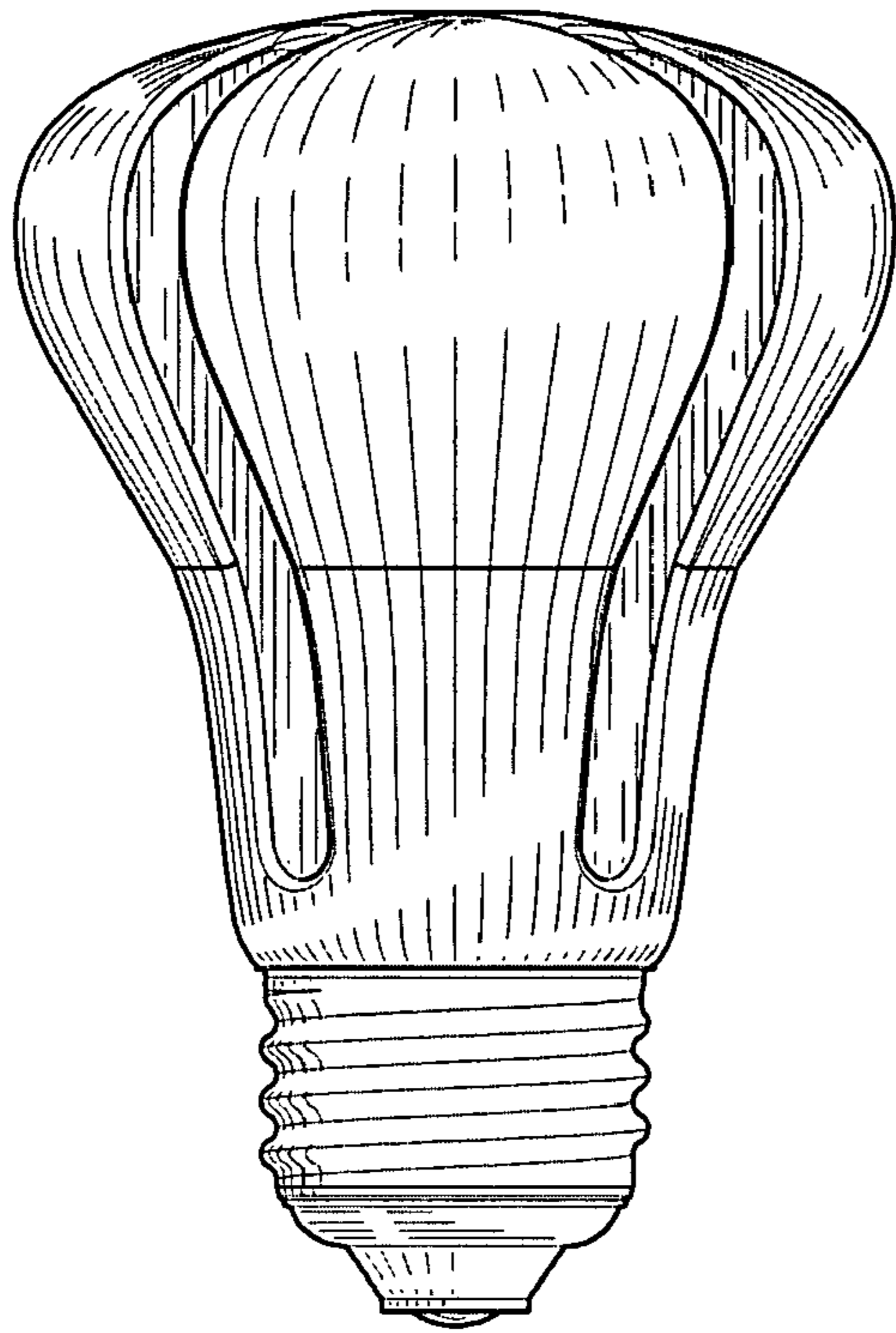

FIG. 4

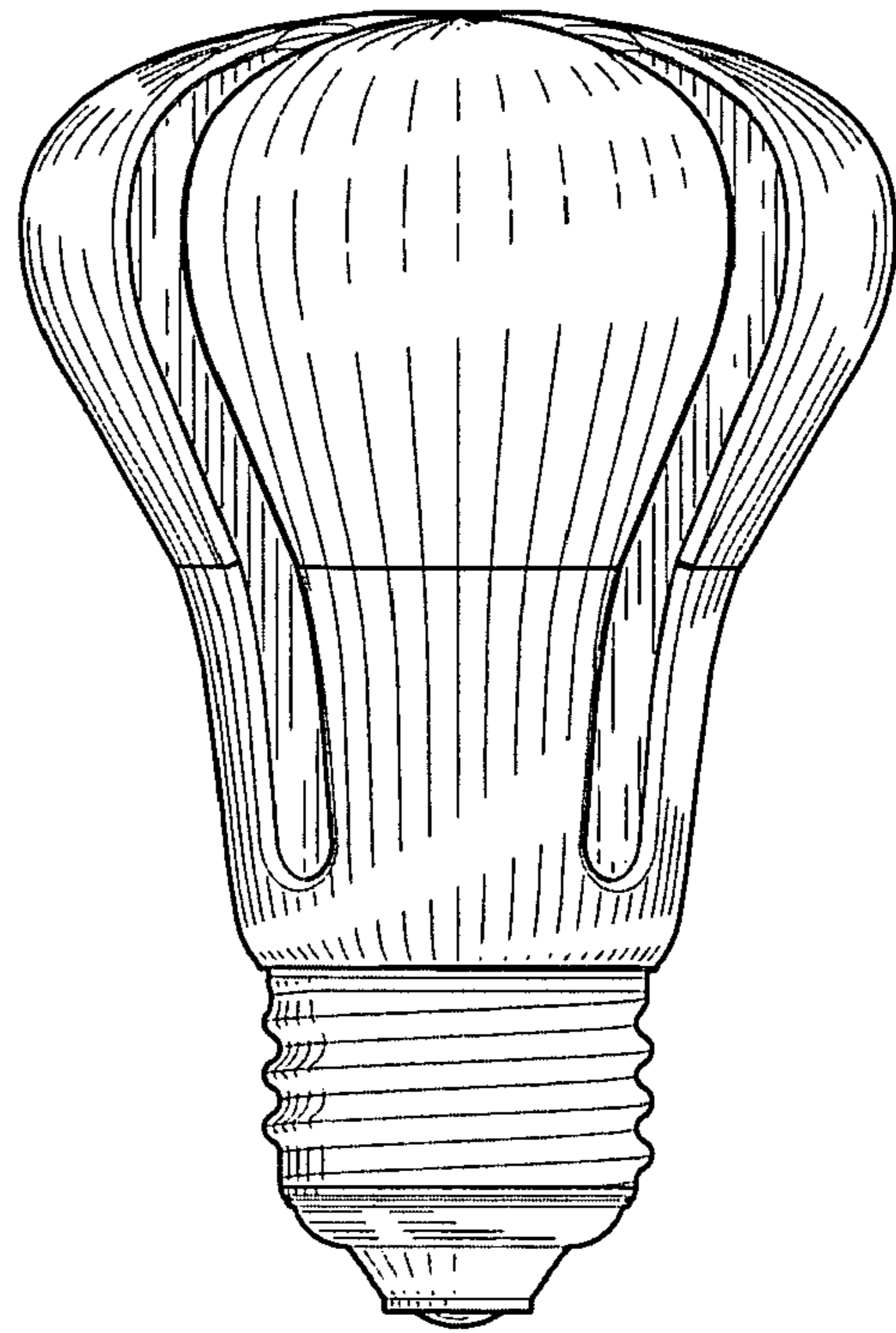

FIG. 5

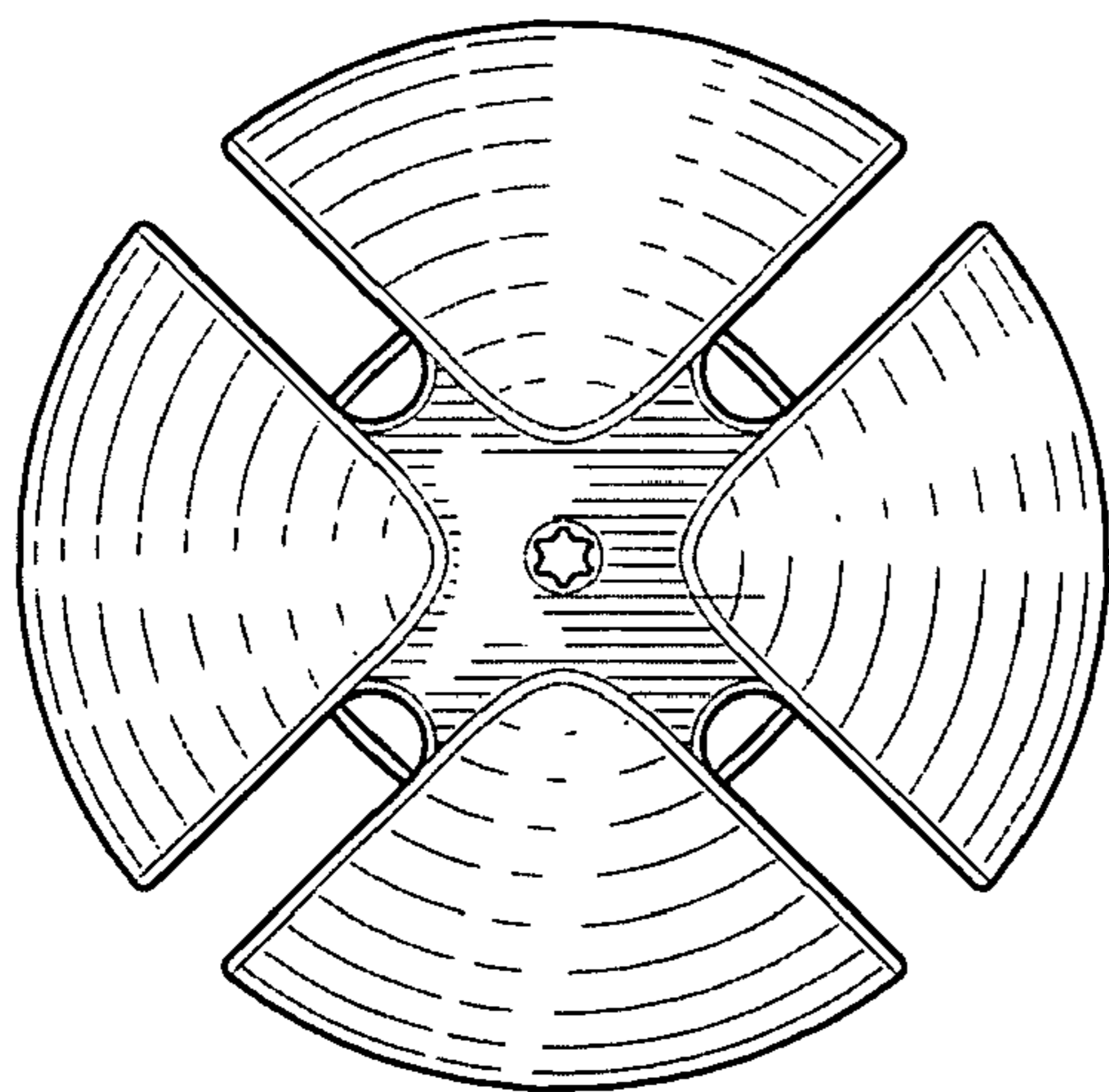

FIG. 6

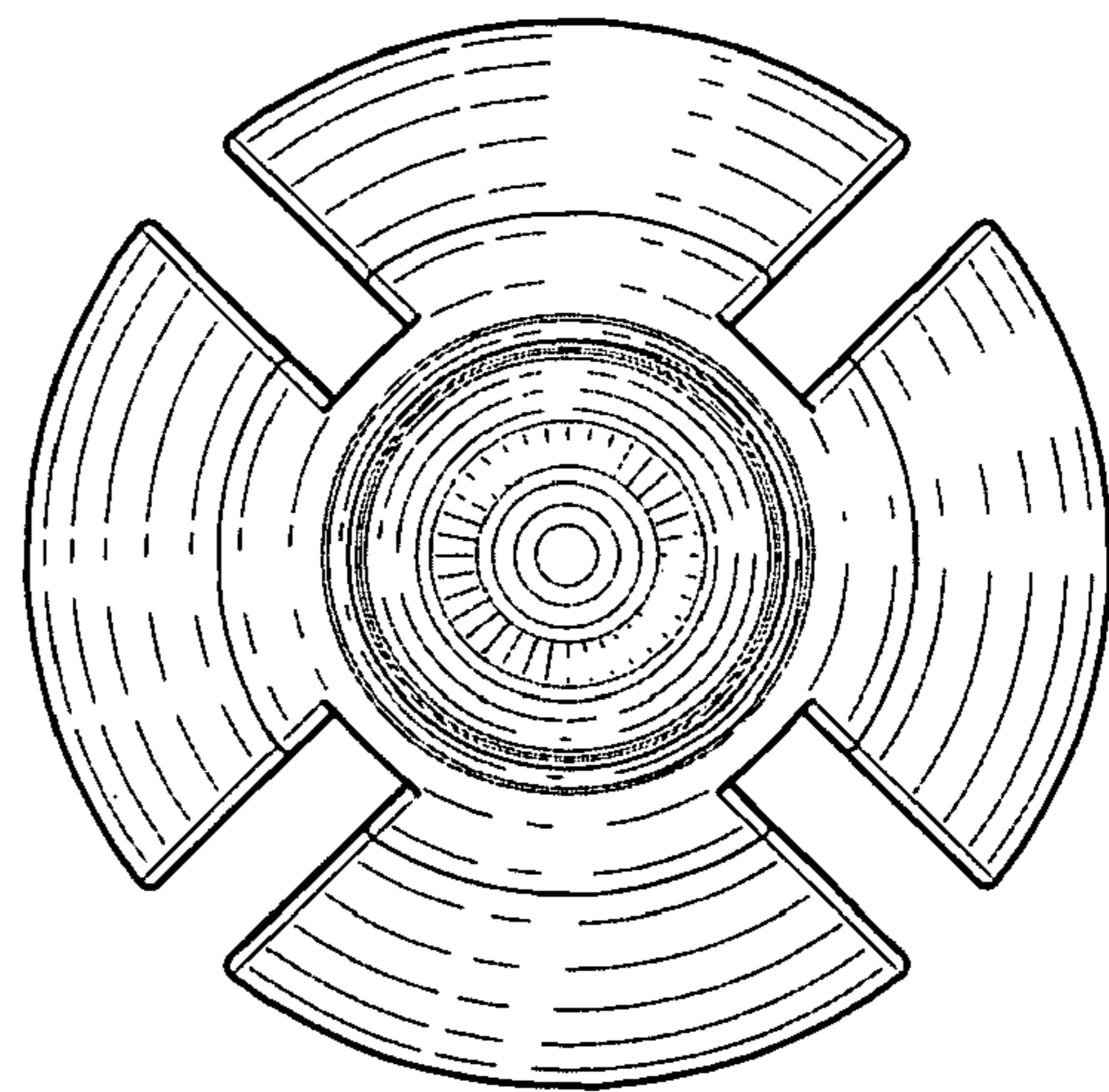

FIG. 7