



US00D598051S

(12) **United States Design Patent**  
**Englert et al.**

(10) **Patent No.:** **US D598,051 S**

(45) **Date of Patent:** **\*\* Aug. 11, 2009**

(54) **DEMONSTRATION DEVICE**

(75) Inventors: **Robert S. Englert**, Syracuse, NY (US);  
**Scott W. Osiecki**, Skaneateles, NY (US)

(73) Assignee: **The Iams Company**, Dayton, OH (US)

(\*\*) Term: **14 Years**

(21) Appl. No.: **29/292,408**

(22) Filed: **Oct. 11, 2007**

(51) **LOC (9) Cl.** ..... **19-07**

(52) **U.S. Cl.** ..... **D19/62**

(58) **Field of Classification Search** ..... D19/59-64;  
434/128, 393, 429, 433; D6/301, 304, 359,  
D6/435, 452, 564; D10/7, 109; D20/14,  
D20/30-31; D21/635, 781, 832

See application file for complete search history.

(56) **References Cited**

**U.S. PATENT DOCUMENTS**

D295,054 S *	4/1988	Allen	.....	D6/301
D321,370 S *	11/1991	Curtis	.....	D21/635
D351,632 S *	10/1994	Mitchell	.....	D19/62
D414,815 S *	10/1999	McDonald	.....	D20/31
D429,472 S *	8/2000	Austin	.....	D20/31
D466,825 S *	12/2002	Ettridge et al.	.....	D10/109
D539,373 S *	3/2007	Cook	.....	D21/781
D546,391 S *	7/2007	Peters, Jr.	.....	D19/62

\* cited by examiner

*Primary Examiner*—T. Chase Nelson

*Assistant Examiner*—Mark Cavanna

(74) *Attorney, Agent, or Firm*—Kristin Kohler; SarahAnn Dressel; Roddy M. Bullock

(57) **CLAIM**

The ornamental design for a demonstration device, as shown and described.

**DESCRIPTION**

FIG. 1 is a front perspective view of a demonstration device showing our new design;

FIG. 2 is a rear perspective view thereof;

FIG. 3 is a front view thereof;

FIG. 4 is a rear view thereof;

FIG. 5 is a left side view thereof;

FIG. 6 is a right side view thereof;

FIG. 7 is a top plan view thereof; and,

FIG. 8 is a bottom view thereof.

The broken lines shown in the interior of the rectangular area of the chute portion of the demonstration device shown in FIG. 7 are included for the purpose of illustrating a portion of the demonstration device that forms no part of the claimed design.

**1 Claim, 8 Drawing Sheets**

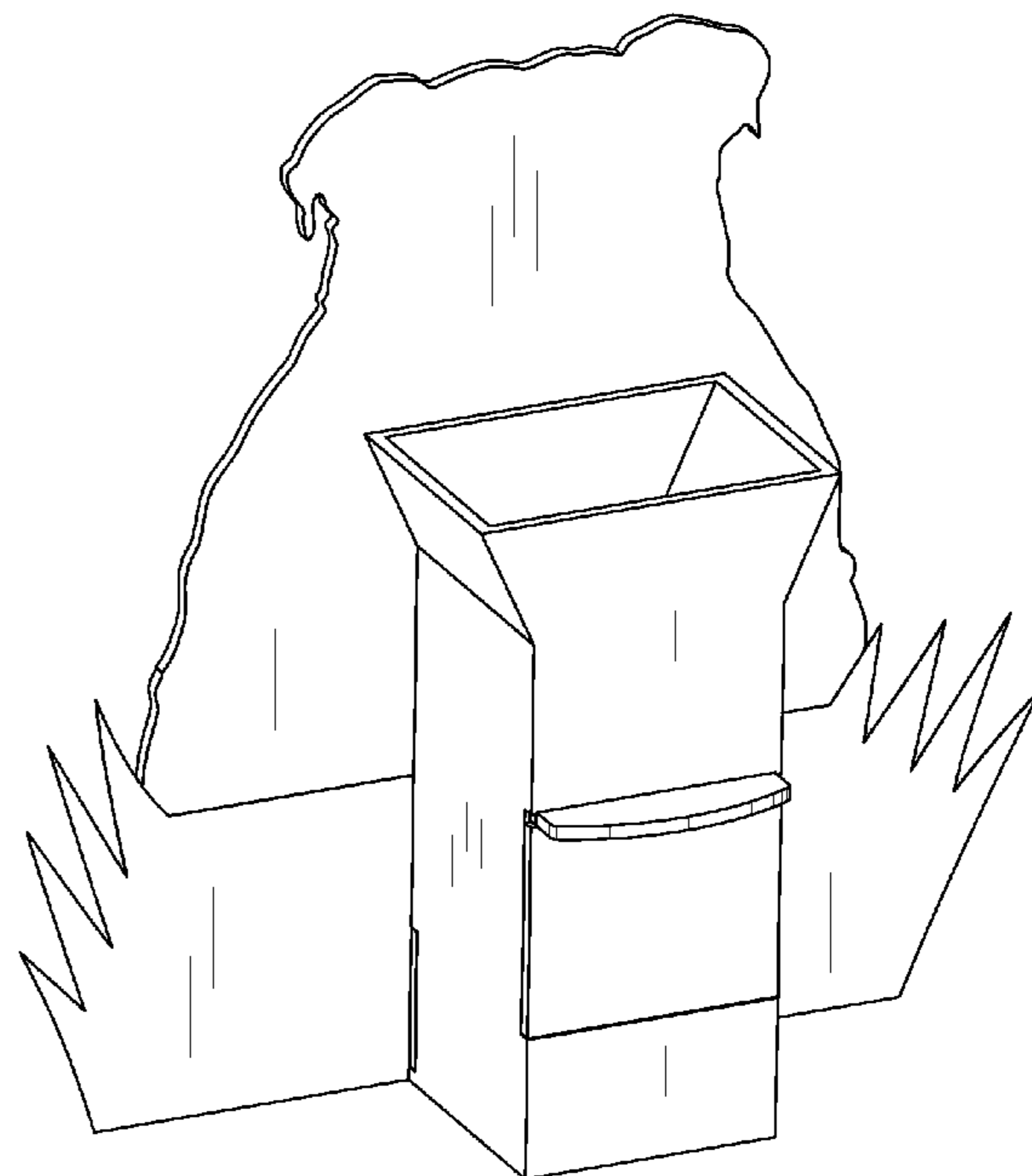
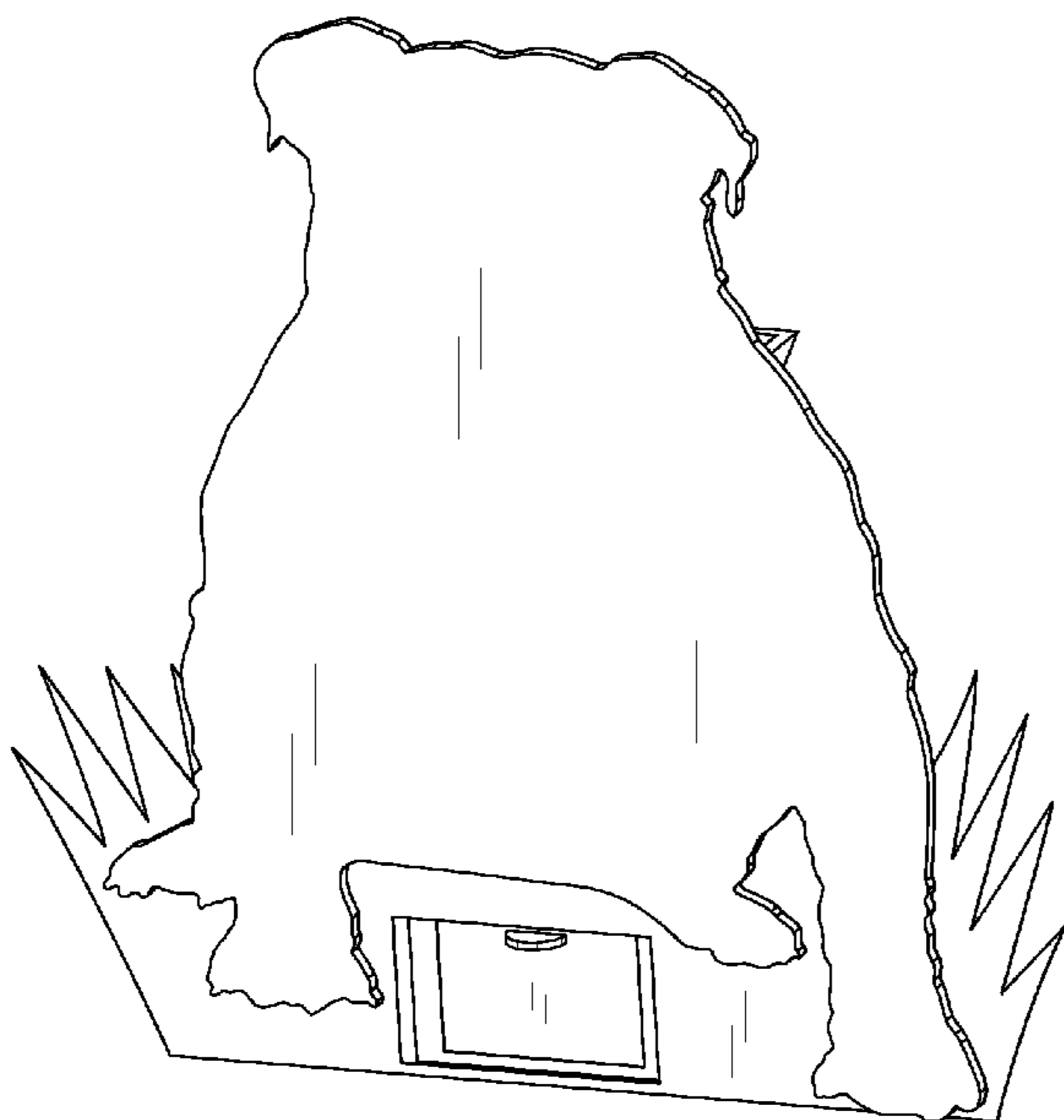

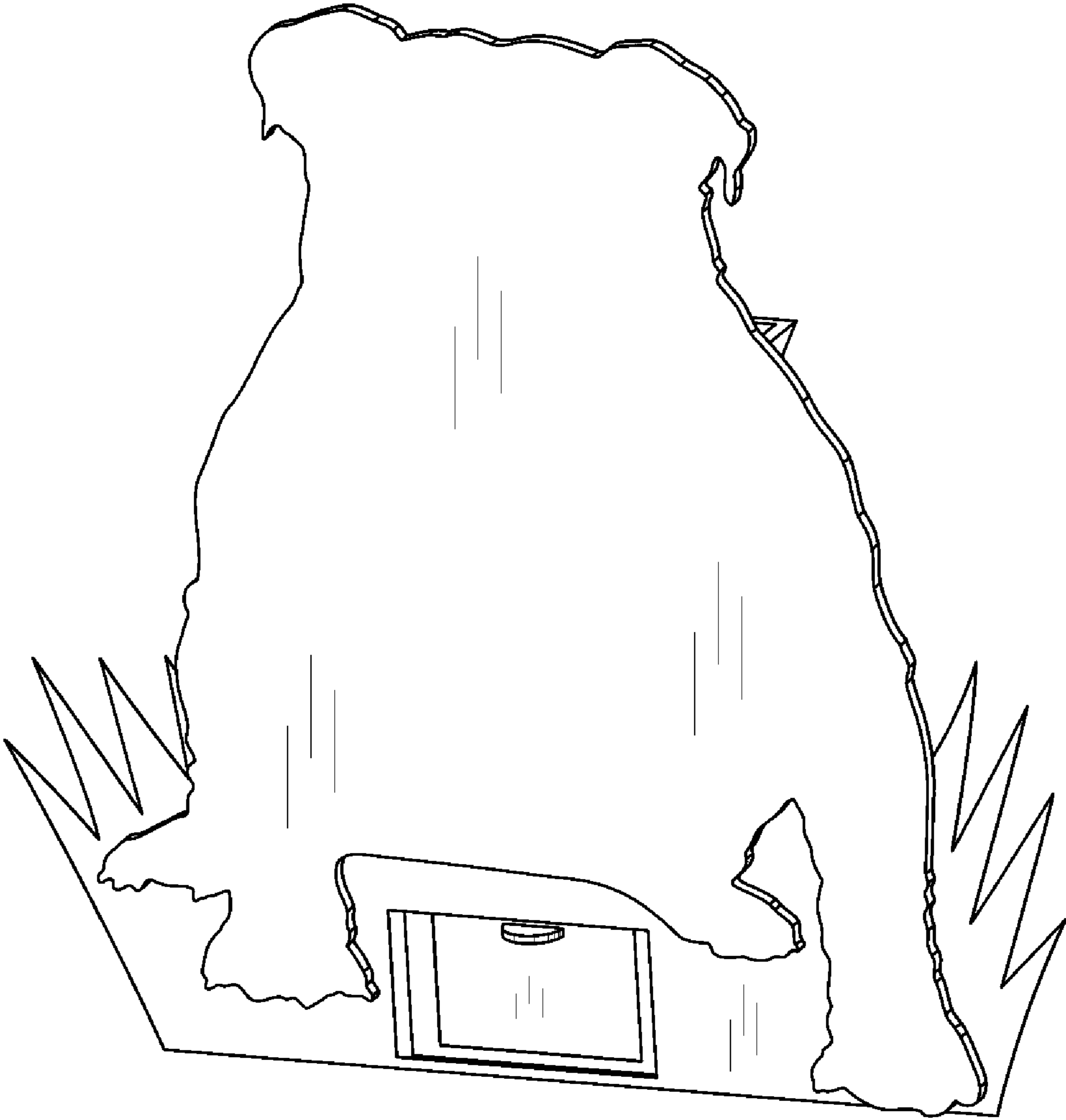

Fig. 1

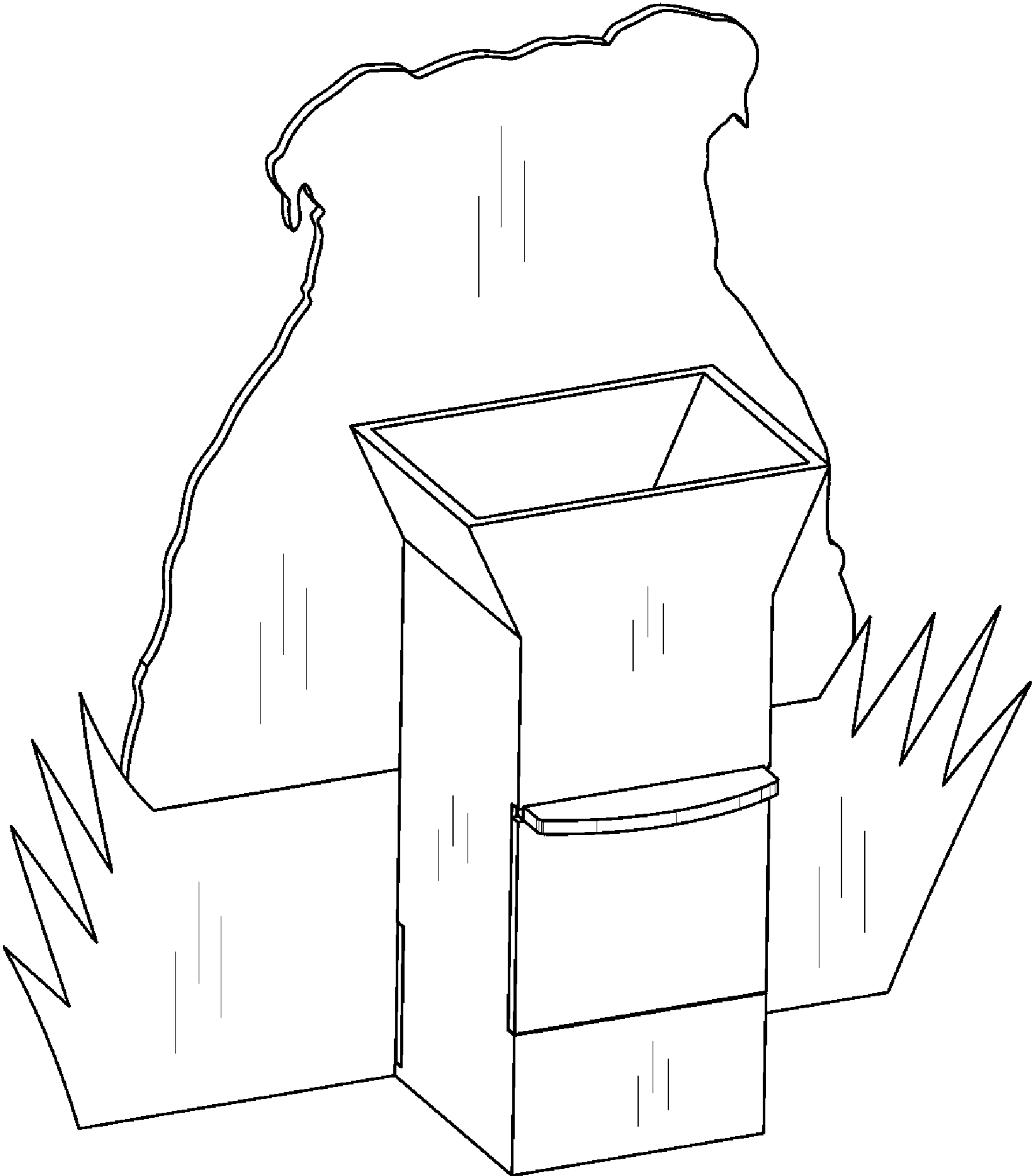

Fig. 2

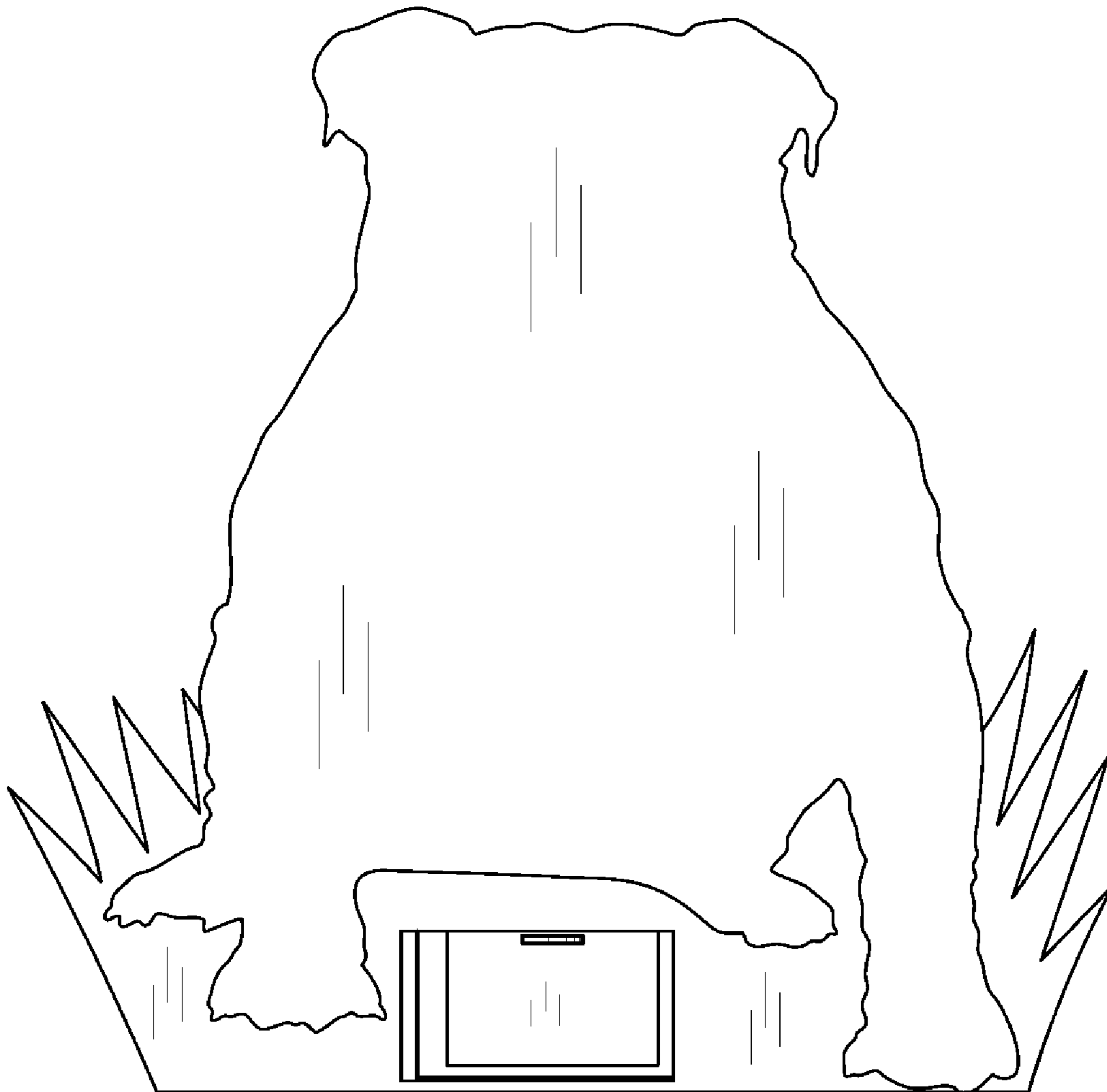

Fig. 3

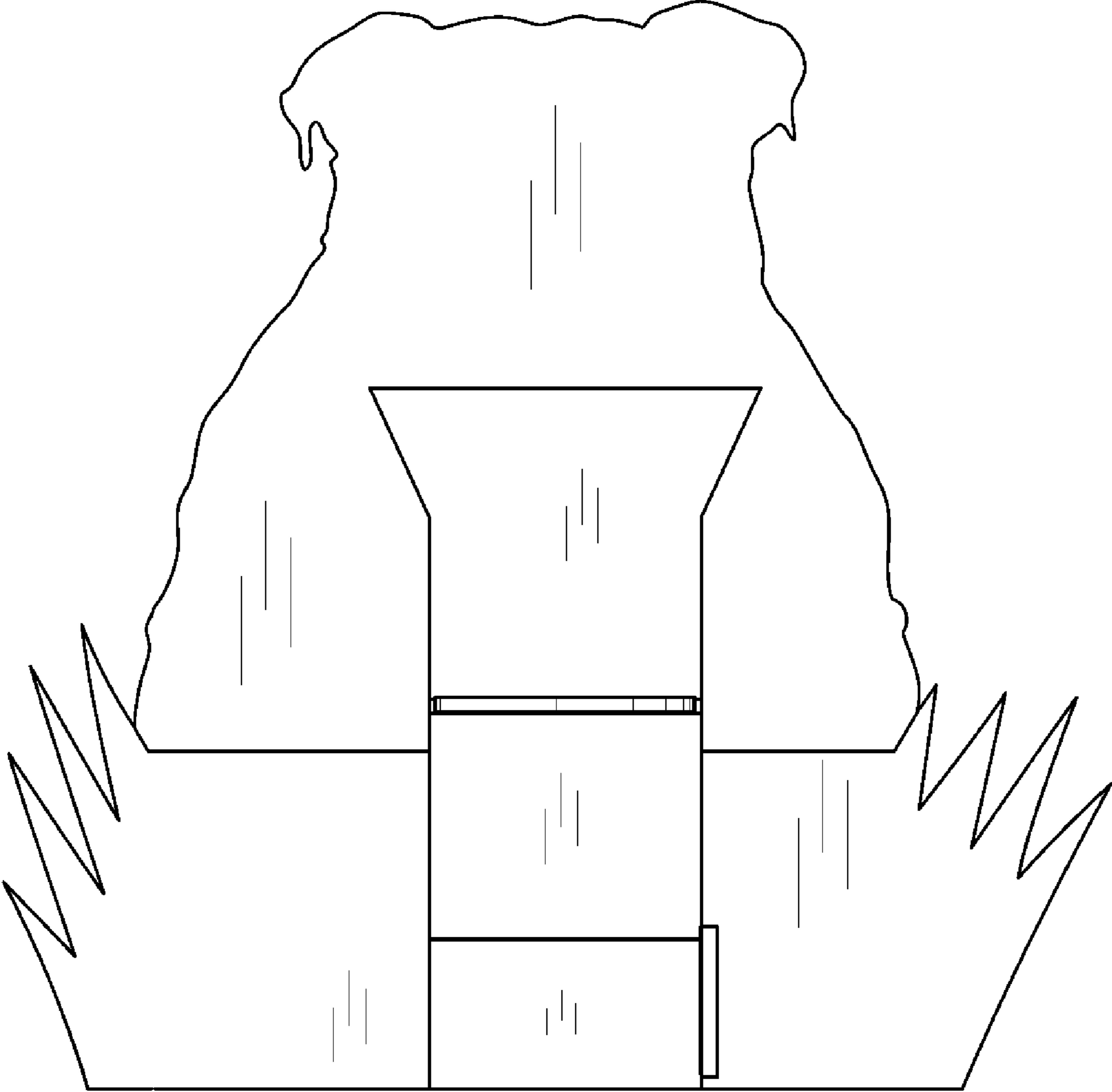

Fig. 4

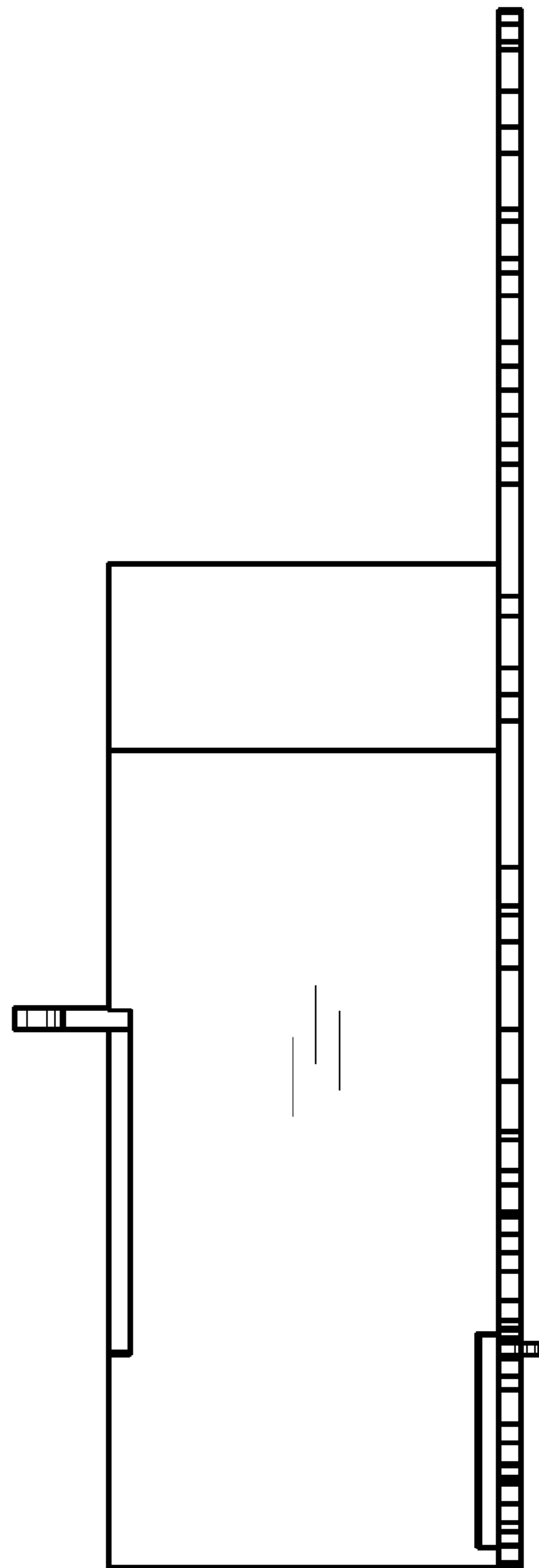

Fig. 5

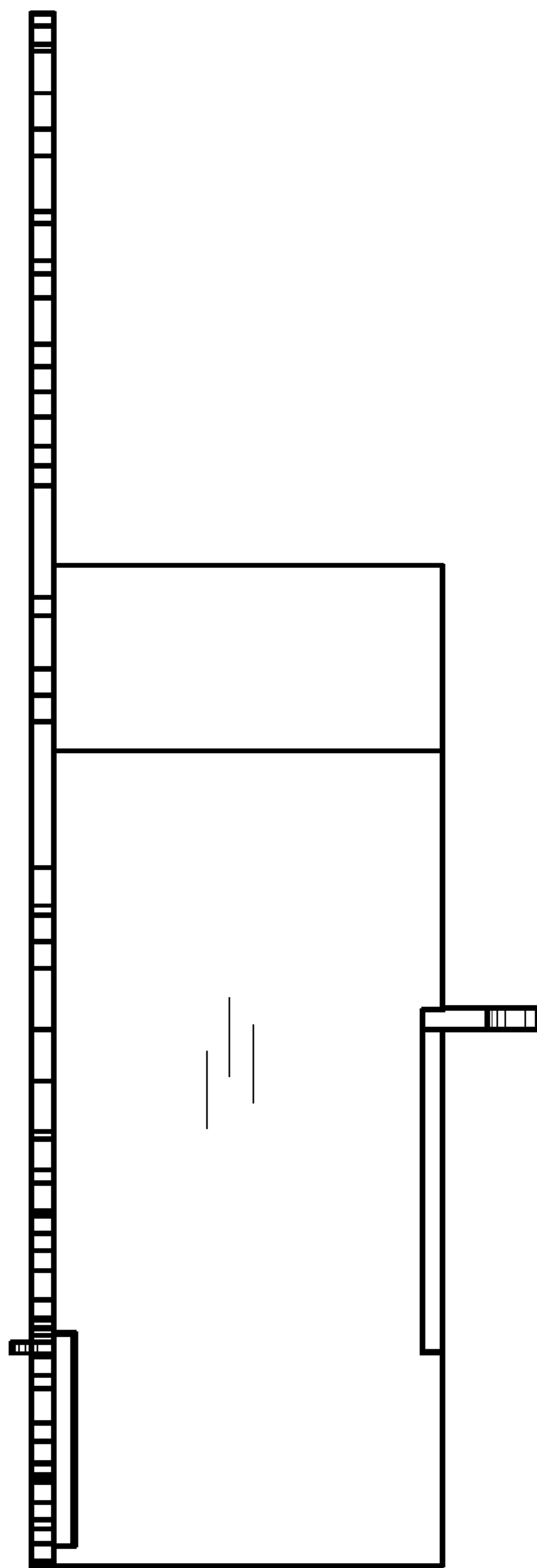

Fig. 6

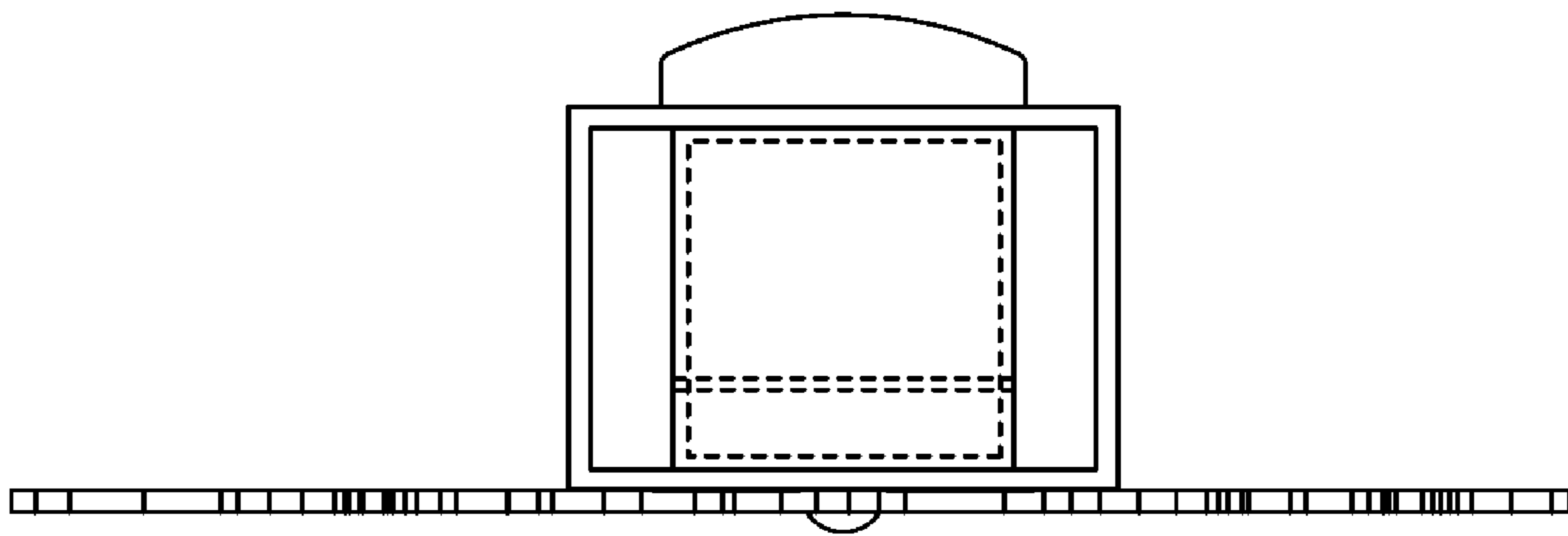

Fig. 7



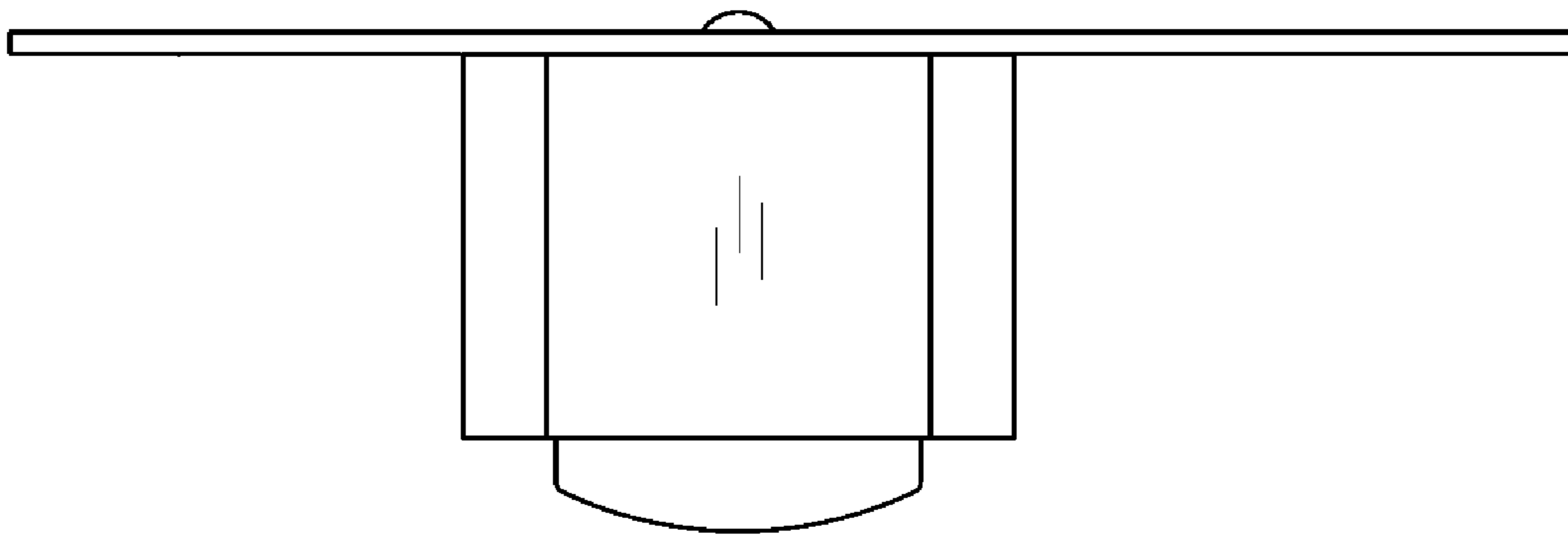

Fig. 8