



US00D598003S

(12) **United States Design Patent**
Park

(10) **Patent No.:** **US D598,003 S**

(45) **Date of Patent:** **** Aug. 11, 2009**

(54) **SPEAKERPHONE DEVICE**

(75) Inventor: **Cheol Woo Park**, Chicago, IL (US)

(73) Assignee: **Motorola, Inc.**, Schaumburg, IL (US)

(**) Term: **14 Years**

(21) Appl. No.: **29/328,369**

(22) Filed: **Nov. 24, 2008**

(51) **LOC (9) Cl.** **14-03**

(52) **U.S. Cl.** **D14/149**

(58) **Field of Classification Search** D14/130,
D14/137, 140, 140.1, 140.8, 141.1, 141.3,
D14/142, 149–151, 158–159, 168, 171–172,
D14/188, 211, 214, 225–226, 240, 243, 251,
D14/253, 299, 336, 215, 167, 210, 212, 509;
379/387.01, 388.02, 420.02, 447, 453, 434;
381/16; D13/107–108, 168; 455/351
See application file for complete search history.

(56) **References Cited**

U.S. PATENT DOCUMENTS

D367,274 S *	2/1996	Gobindram	D14/149
D376,593 S *	12/1996	Riggs	D14/137
5,946,610 A *	8/1999	Hama	455/351
D432,514 S *	10/2000	Nakamura et al.	D14/509
D481,370 S *	10/2003	Popowski et al.	D14/150
D482,672 S *	11/2003	Takagi	D14/509
D492,279 S *	6/2004	Lee	D14/188
D497,882 S *	11/2004	Huang	D13/168
D504,122 S *	4/2005	Zeitman	D14/509
D522,995 S *	6/2006	Iijima	D14/509
D561,732 S *	2/2008	Motoishi	D14/509
D568,304 S *	5/2008	Park	D14/240
D577,009 S *	9/2008	Wilson et al.	D14/225

OTHER PUBLICATIONS

Konftel KT50, <URL:http://www.101phones.com/details/11393-6386/Konftel-Conference-Phones-KT50.html>, retrieved from internet Mar. 10, 2009.*

* cited by examiner

Primary Examiner—Ian Simmons

Assistant Examiner—Carla Jobe Wright

(57) **CLAIM**

The ornamental design for a speakerphone device, as shown and described.

DESCRIPTION

FIG. 1 is a perspective view of a first embodiment of an ornamental design for a speakerphone device;

FIG. 2 is a front view of the first embodiment thereof;

FIG. 3 is a rear view of the first embodiment thereof;

FIG. 4 is a first side view of the first embodiment thereof;

FIG. 5 is a second side view of the first embodiment thereof;

FIG. 6 is a top view of the first embodiment thereof; and

FIG. 7 is a bottom view of the first embodiment thereof.

FIG. 8 is a perspective view of a second embodiment of an ornamental design for a speakerphone device;

FIG. 9 is a front view of the second embodiment thereof;

FIG. 10 is a rear view of the second embodiment thereof;

FIG. 11 is a first side view of the second embodiment thereof;

FIG. 12 is a second side view of the second embodiment thereof;

FIG. 13 is a top view of the second embodiment thereof; and,

FIG. 14 is a bottom view of the second embodiment thereof.

The broken line showing of environmental structures in FIGS. 1–7 is for illustrative purposes only and is not part of the scope of the claim of the embodiment in which they are shown.

1 Claim, 8 Drawing Sheets

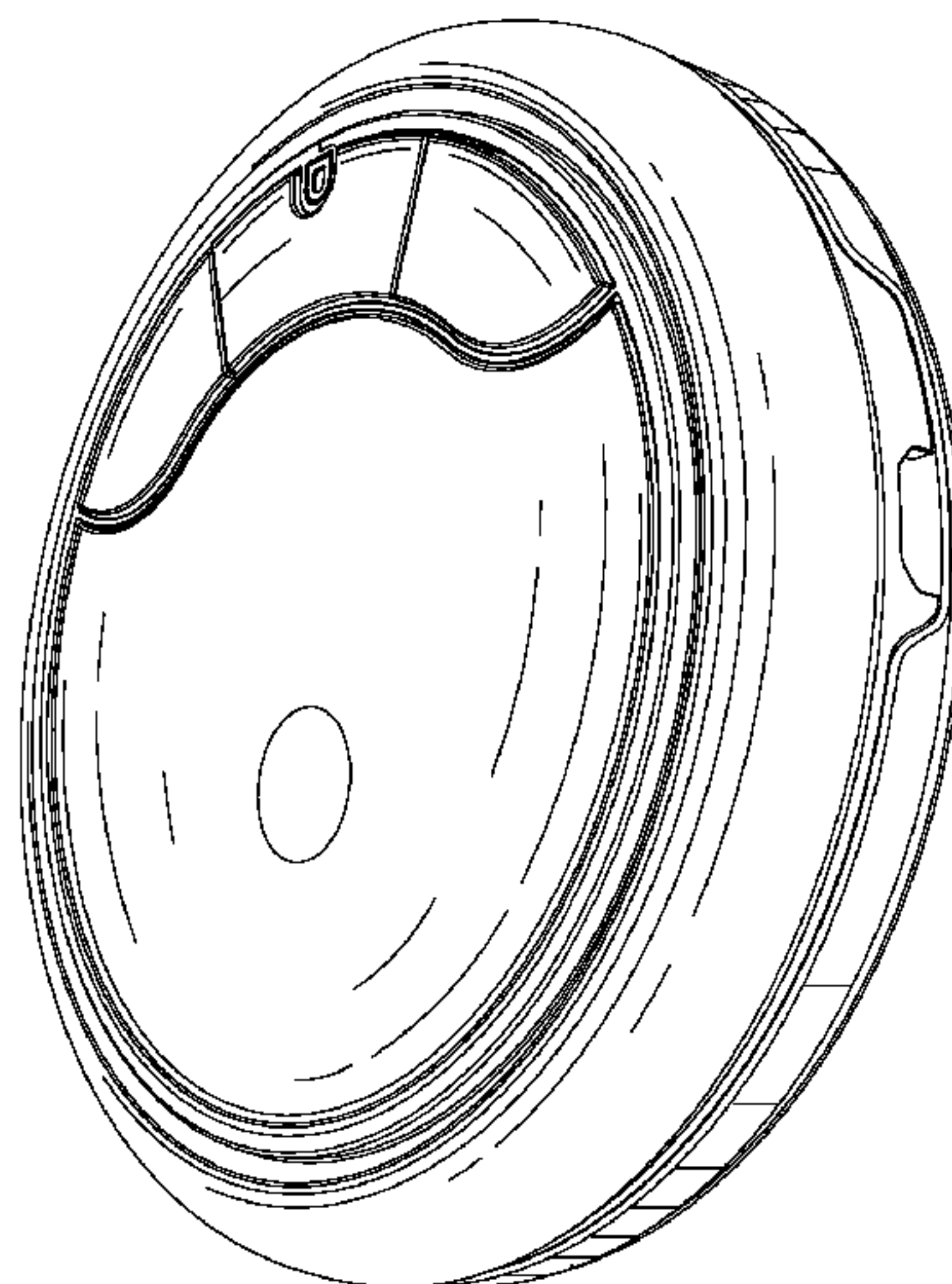

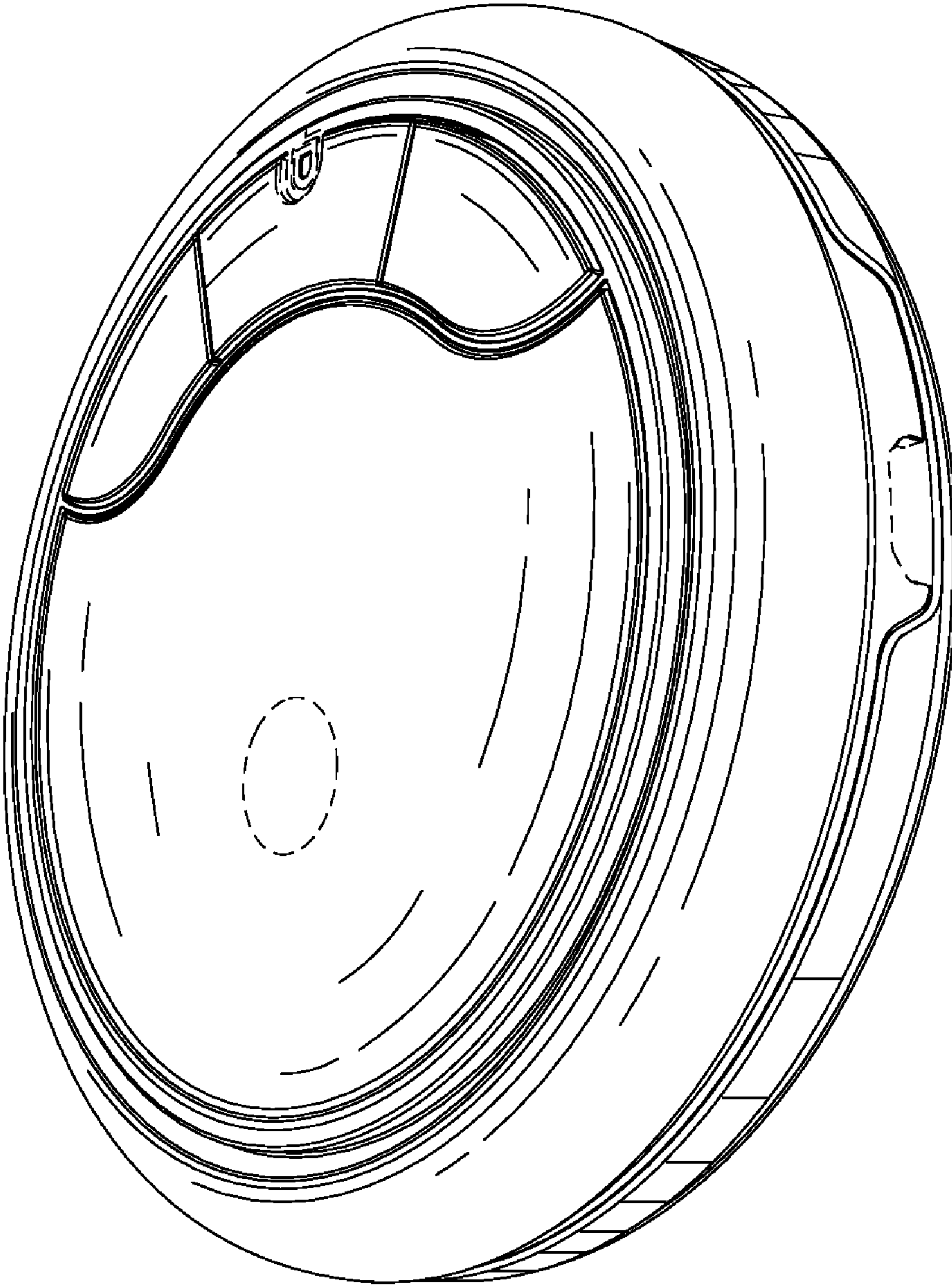

FIG. 1

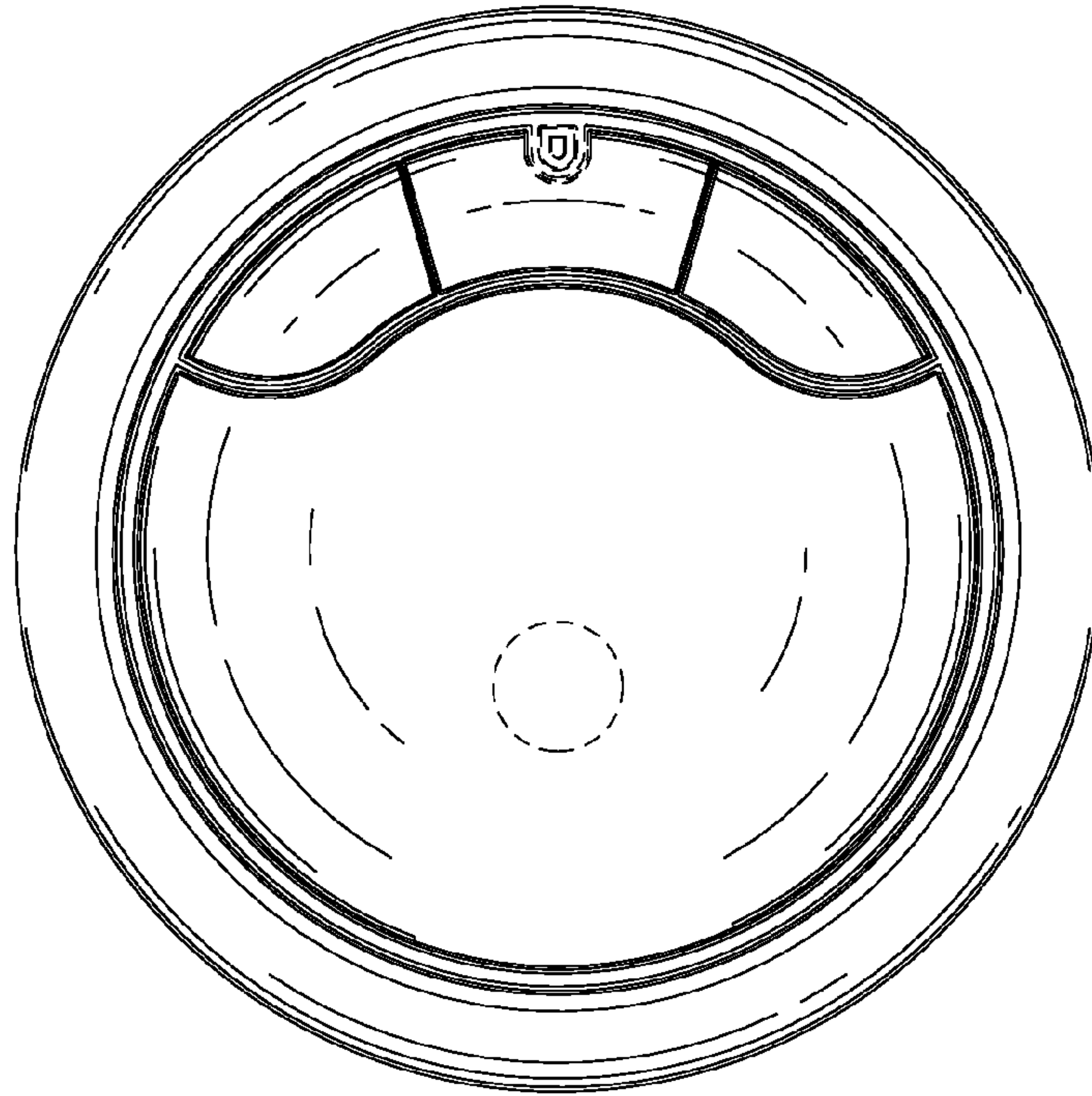

FIG. 2

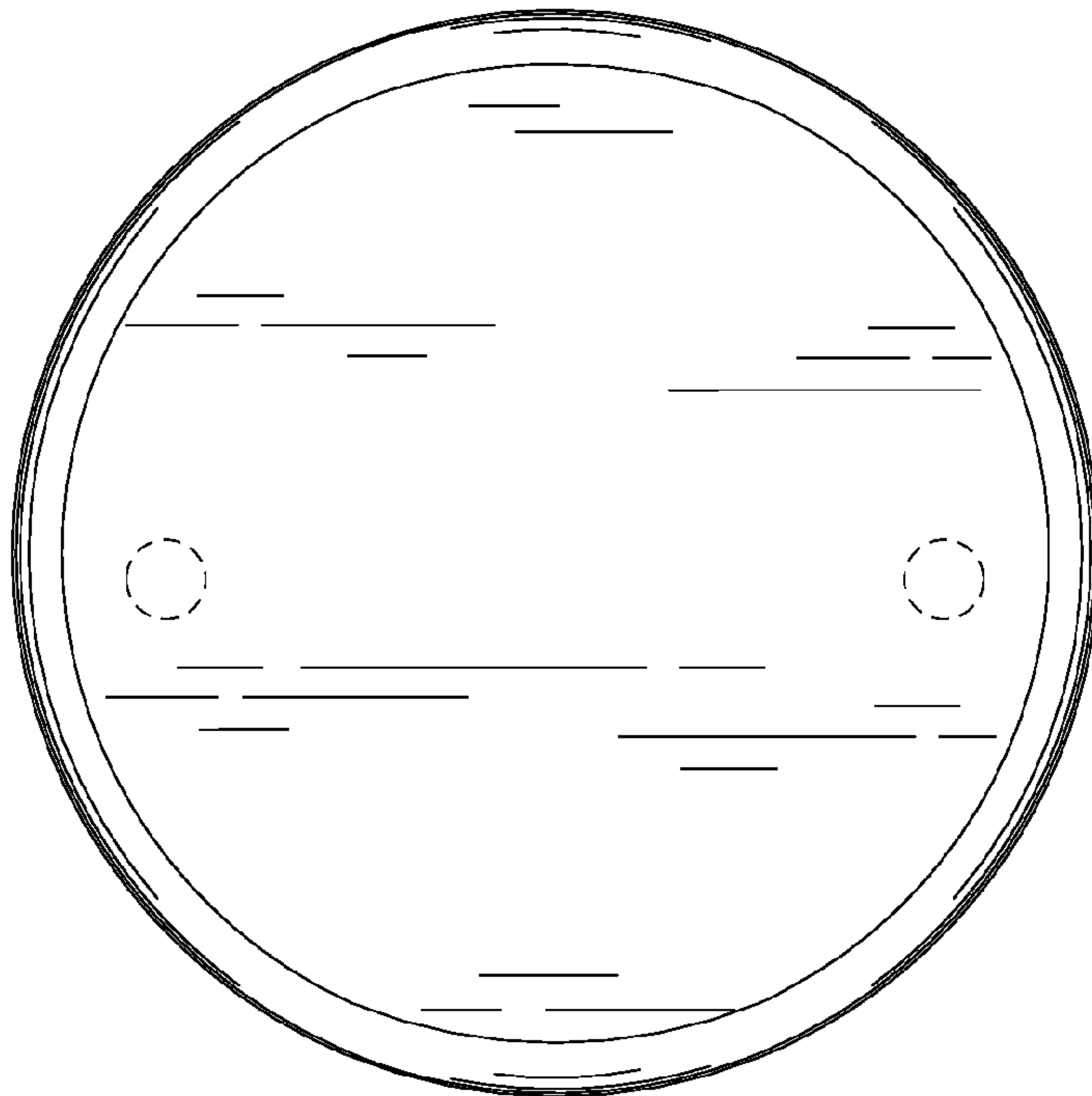

FIG. 3

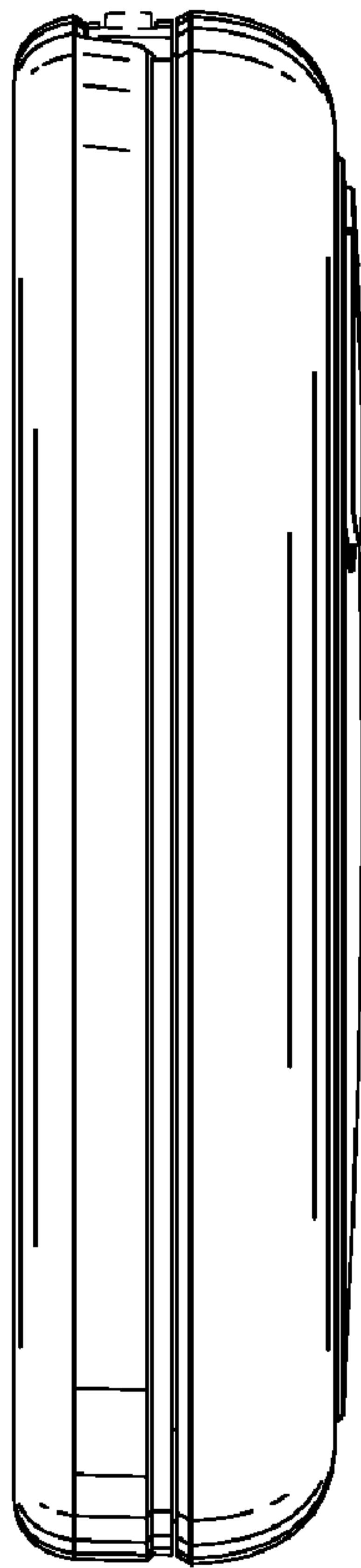

FIG. 4

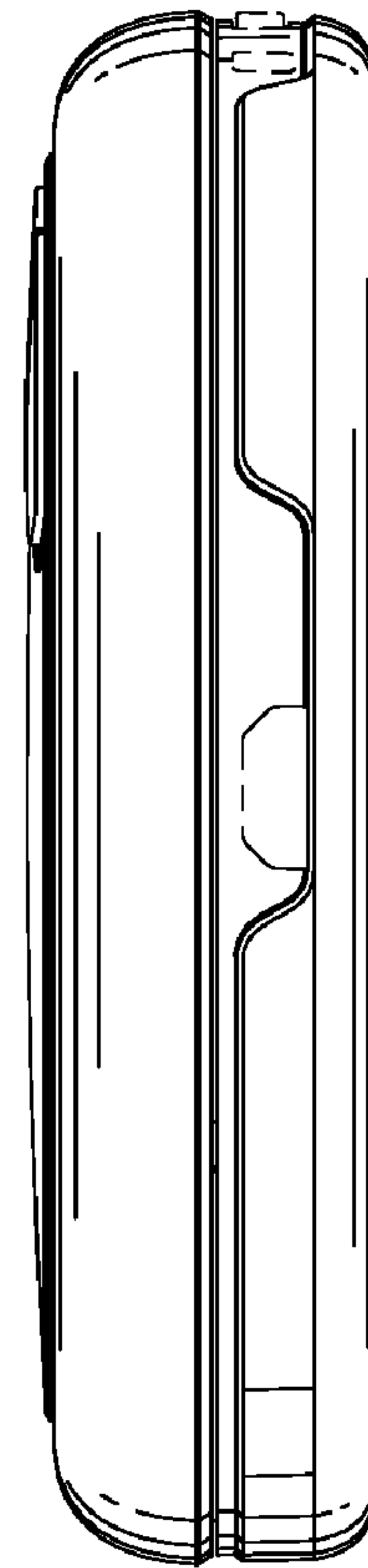

FIG. 5

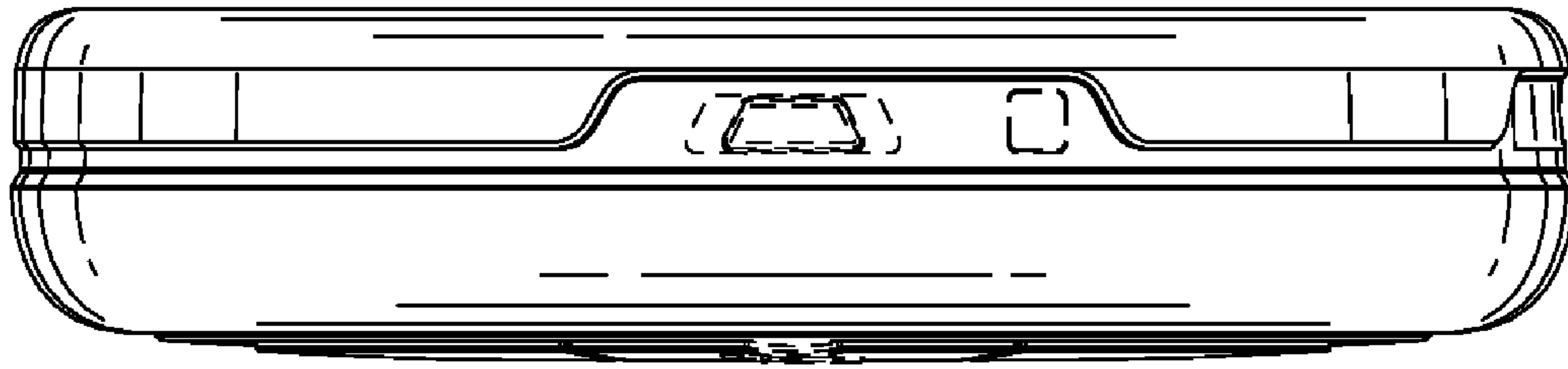

FIG. 6

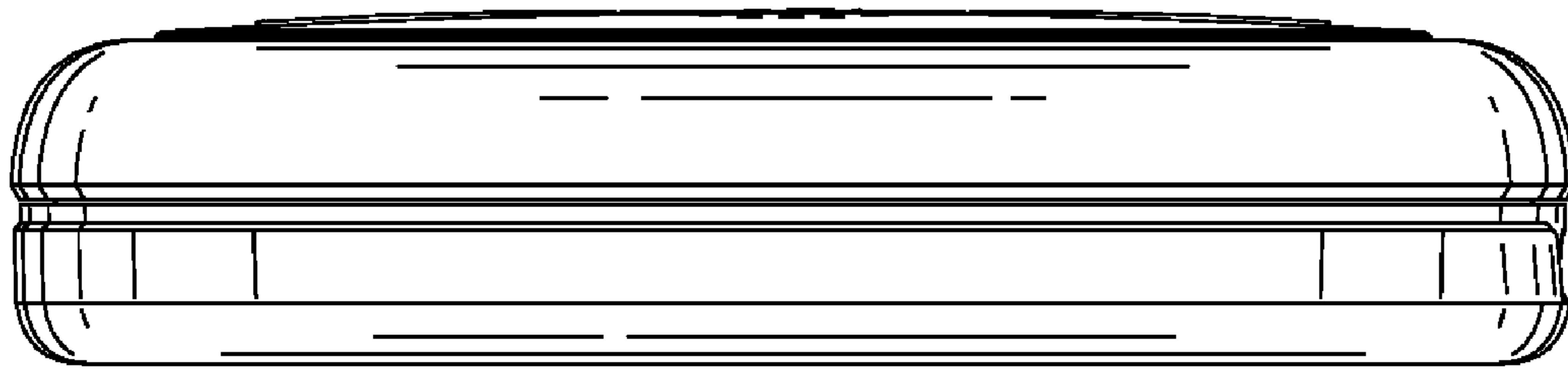

FIG. 7

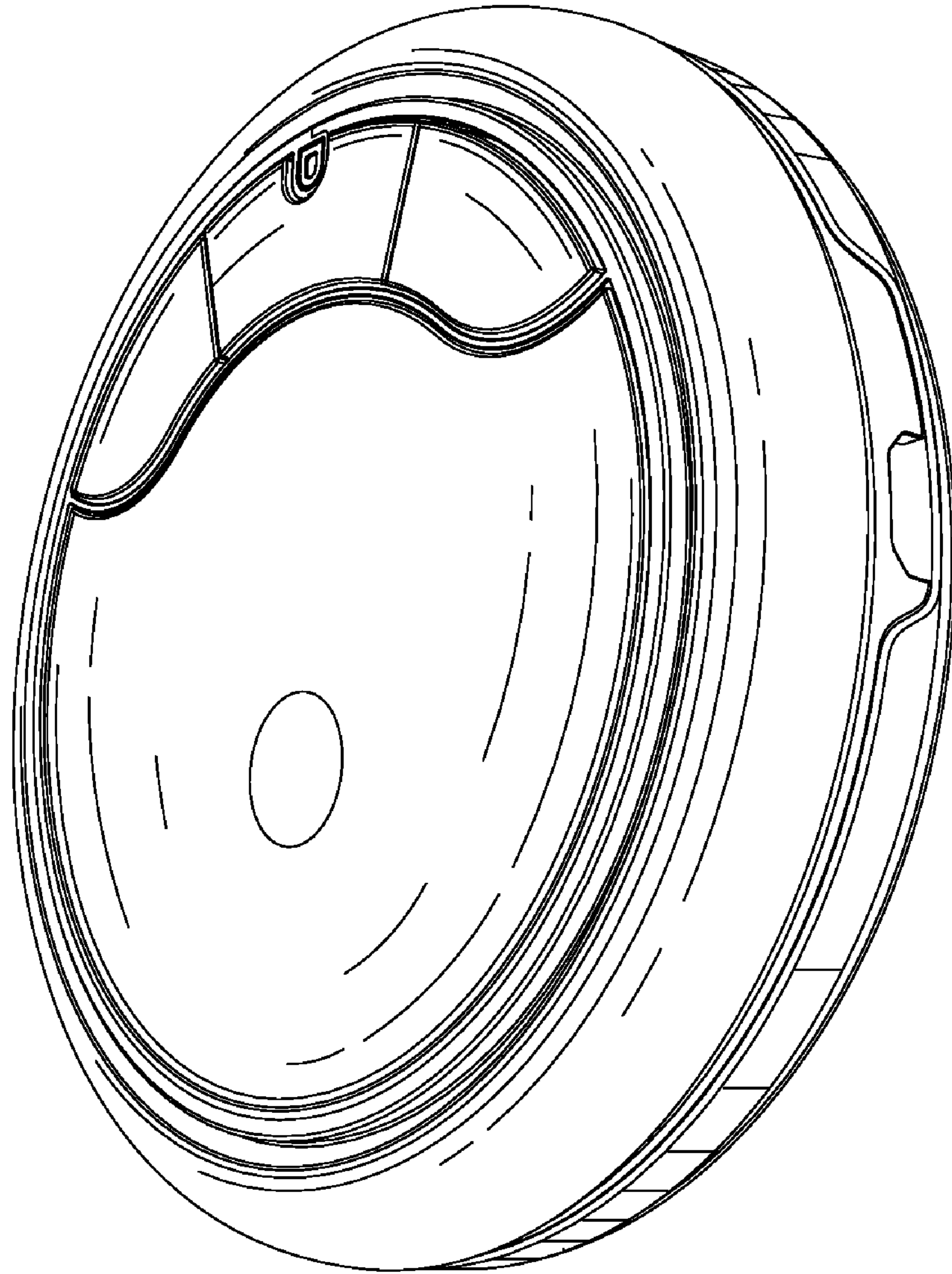

FIG. 8

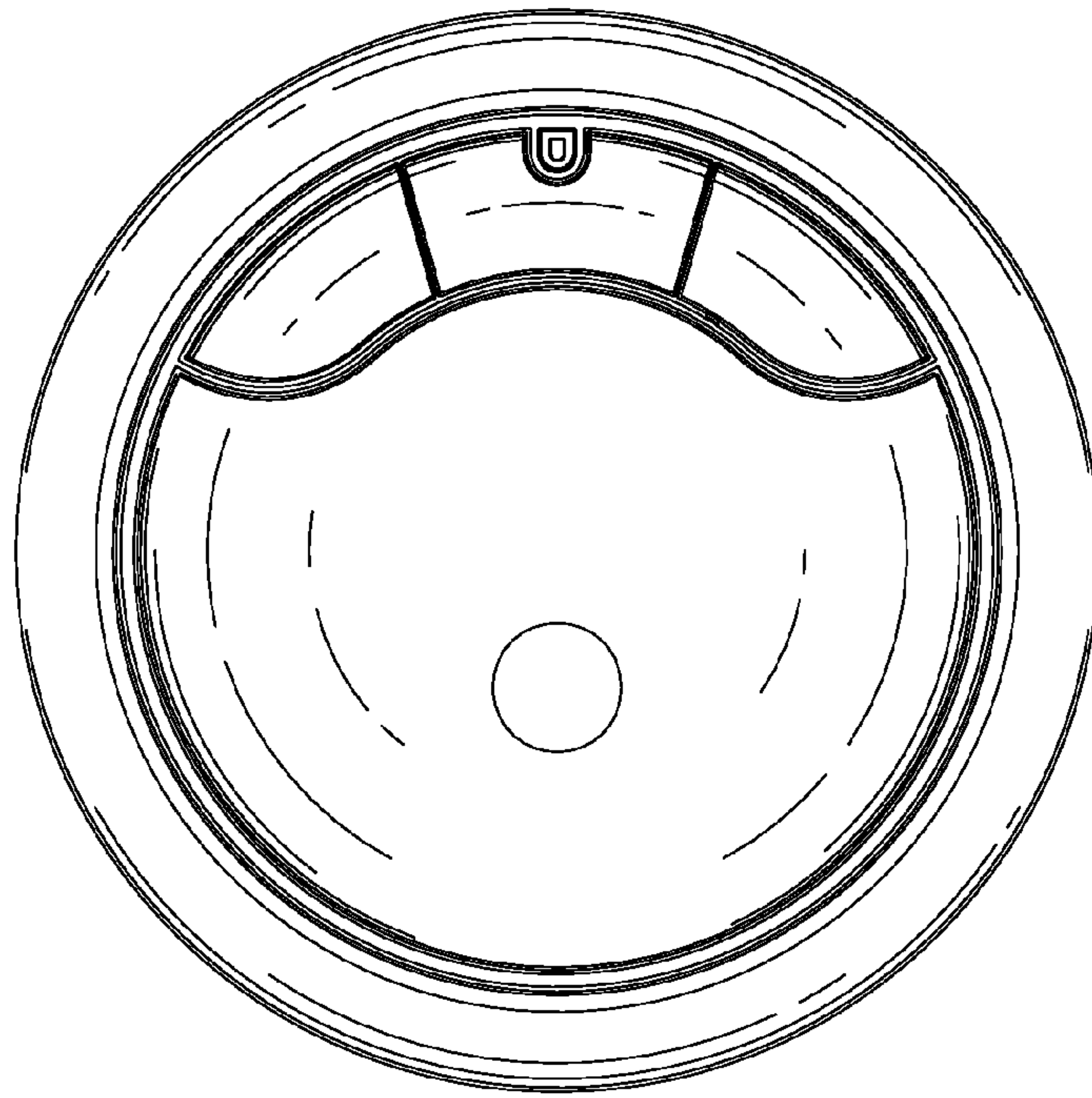

FIG. 9

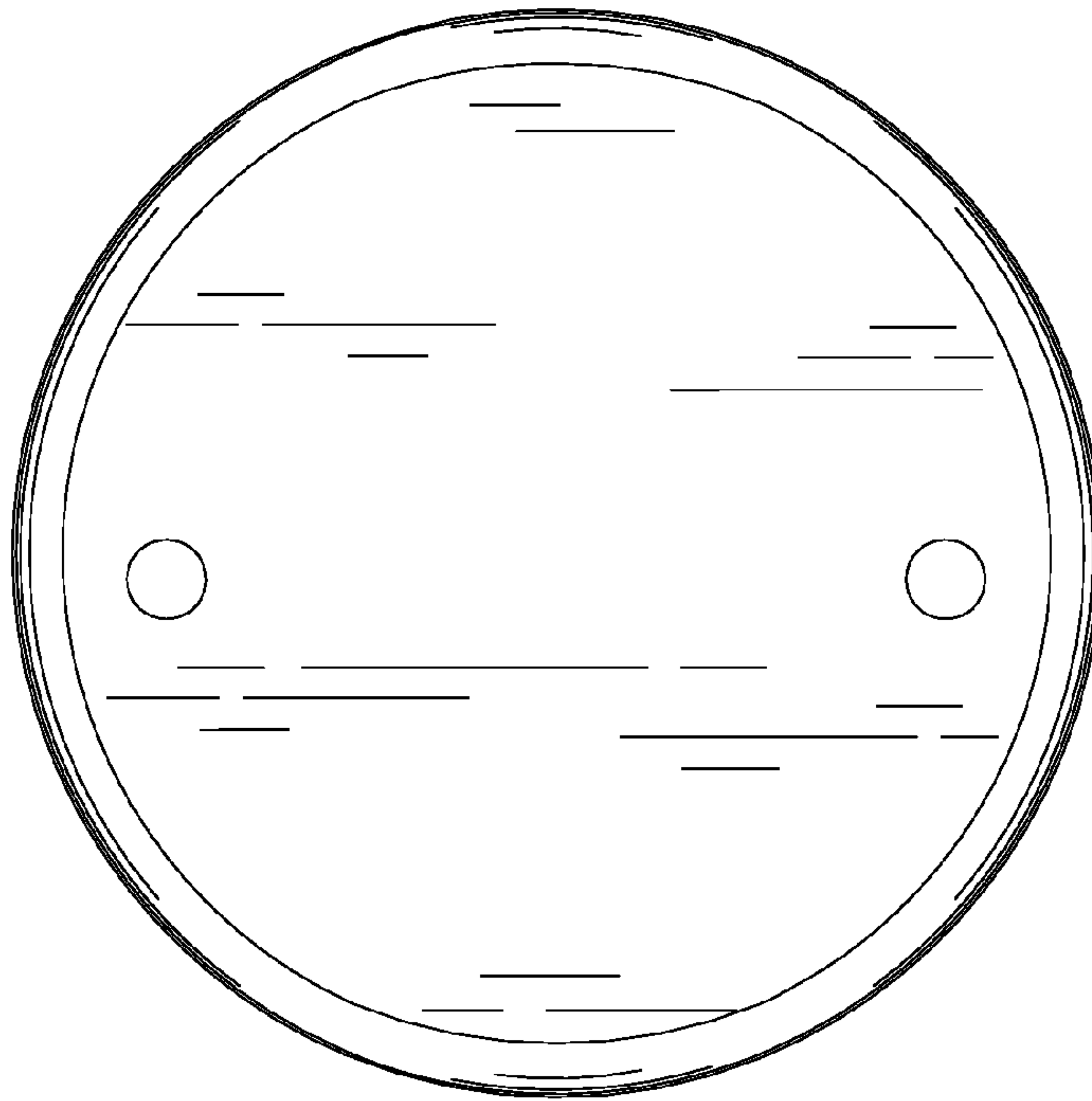

FIG. 10

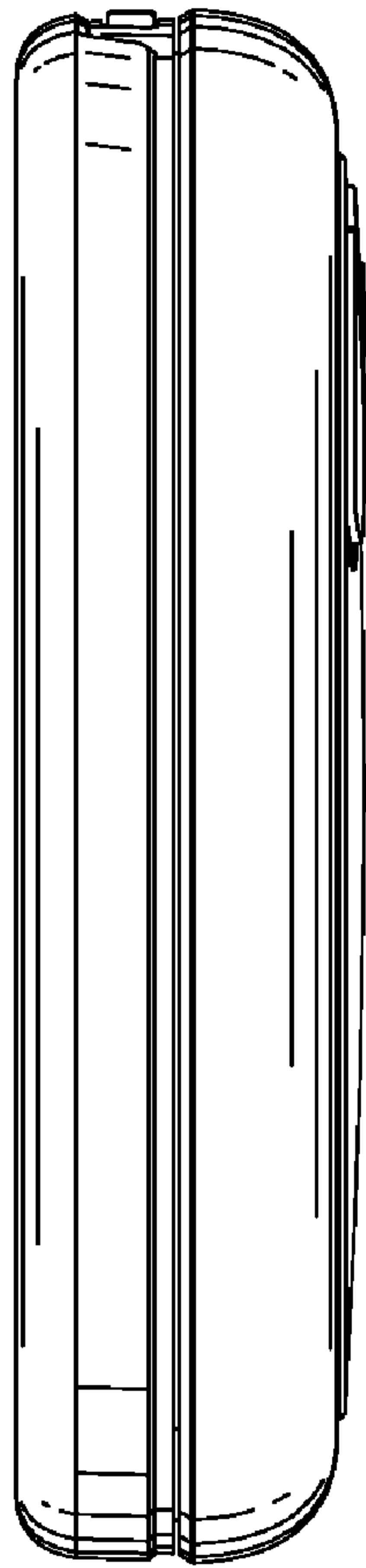

FIG. 11

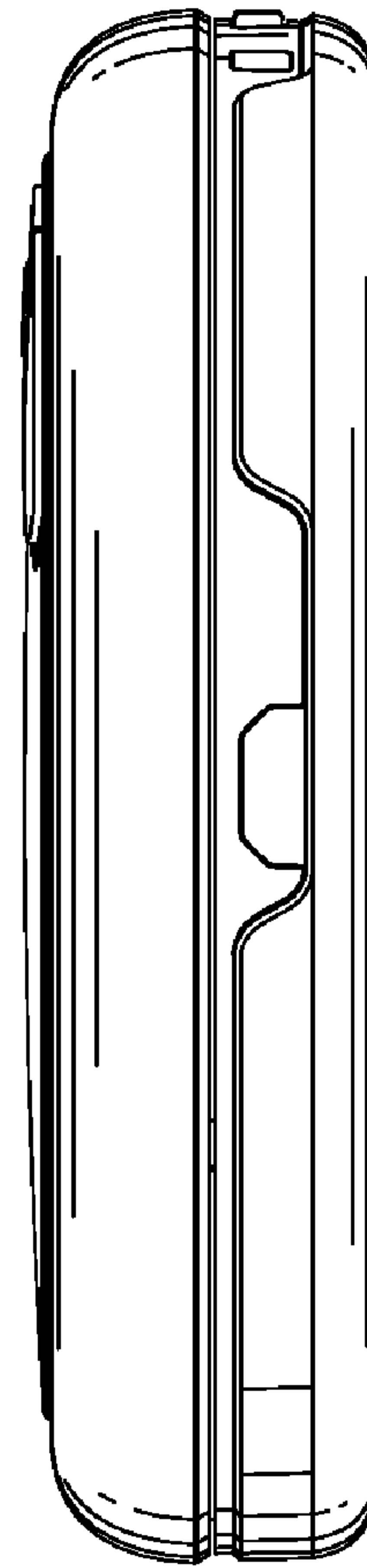

FIG. 12

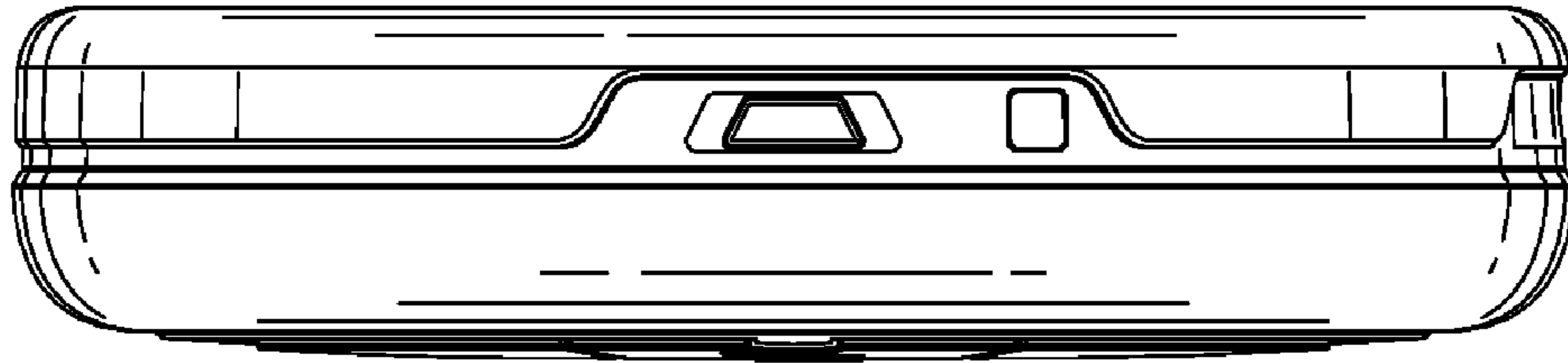

FIG. 13

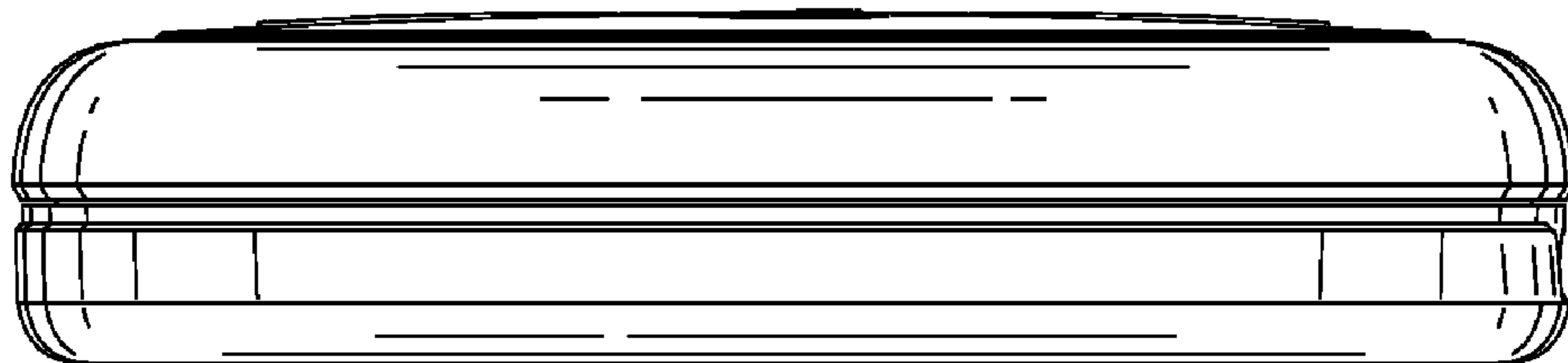

FIG. 14