



US00D597892S

(12) **United States Design Patent**
Andoh

(10) **Patent No.:** **US D597,892 S**

(45) **Date of Patent:** **** Aug. 11, 2009**

(54) **MOTORCYCLE**

(75) **Inventor:** **Seiko Andoh**, Tokyo-to (JP)

(73) **Assignee:** **Yamaha Hatsudoki Kabushiki Kaisha**
(JP)

(**) **Term:** **14 Years**

(21) **Appl. No.:** **29/324,068**

(22) **Filed:** **Sep. 5, 2008**

(51) **LOC (9) Cl.** **12-11**
(52) **U.S. Cl.** **D12/110**
(58) **Field of Classification Search** **D12/110;**
..... **180/219**
See application file for complete search history.

(56) **References Cited**

U.S. PATENT DOCUMENTS

D511,718 S * 11/2005 Manchester et al. D12/110
D524,192 S * 7/2006 Sugimoto D12/110
D567,148 S * 4/2008 Inose et al. D12/110

OTHER PUBLICATIONS

2006 Yamaha Roadliner. [Retrieved on Mar. 23, 2009]. Retrieved from the Internet <URL: <http://www.totalmotorcycle.com/photos/2006models/2006-Yamaha-RoadlinerSb.jpg>>.*

Cycle World Aug. 2005, 2006 Yamaha Roadliner on pp. 30 and 31.*

* cited by examiner

Primary Examiner—Robin V Webster

Assistant Examiner—Linda Brooks

(74) *Attorney, Agent, or Firm*—Ostrolenk, Faber, Gerb & Soffen, LLP

(57) **CLAIM**

The ornamental design for a motorcycle, as shown and described.

DESCRIPTION

FIG. 1 is a right side, front perspective view of my new design;

FIG. 2 is a left side, rear perspective view thereof;

FIG. 3 is a right side view thereof;

FIG. 4 is a left side view thereof;

FIG. 5 is a front view thereof;

FIG. 6 is a rear view thereof; and,

FIG. 7 is a top view thereof.

1 Claim, 6 Drawing Sheets

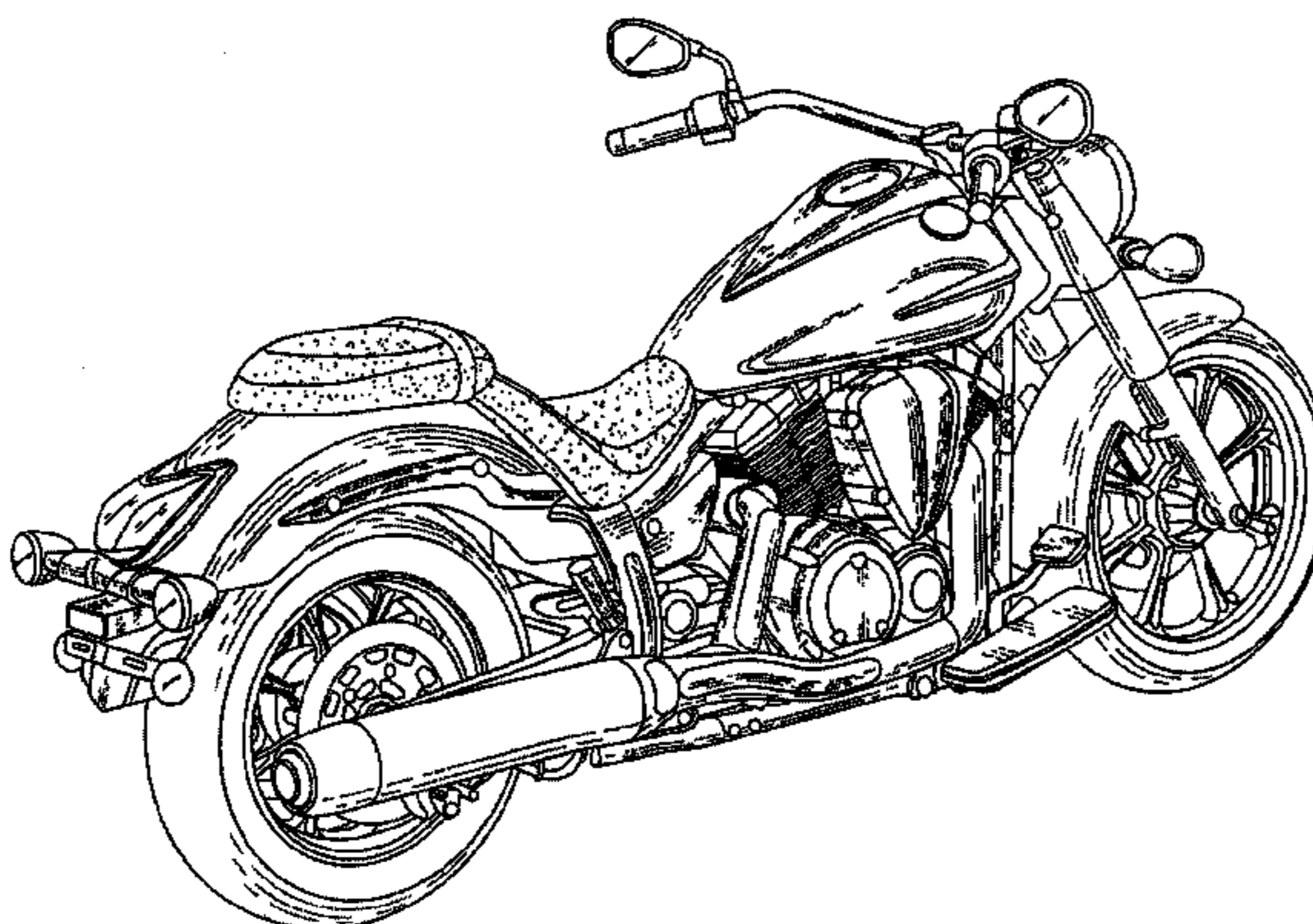
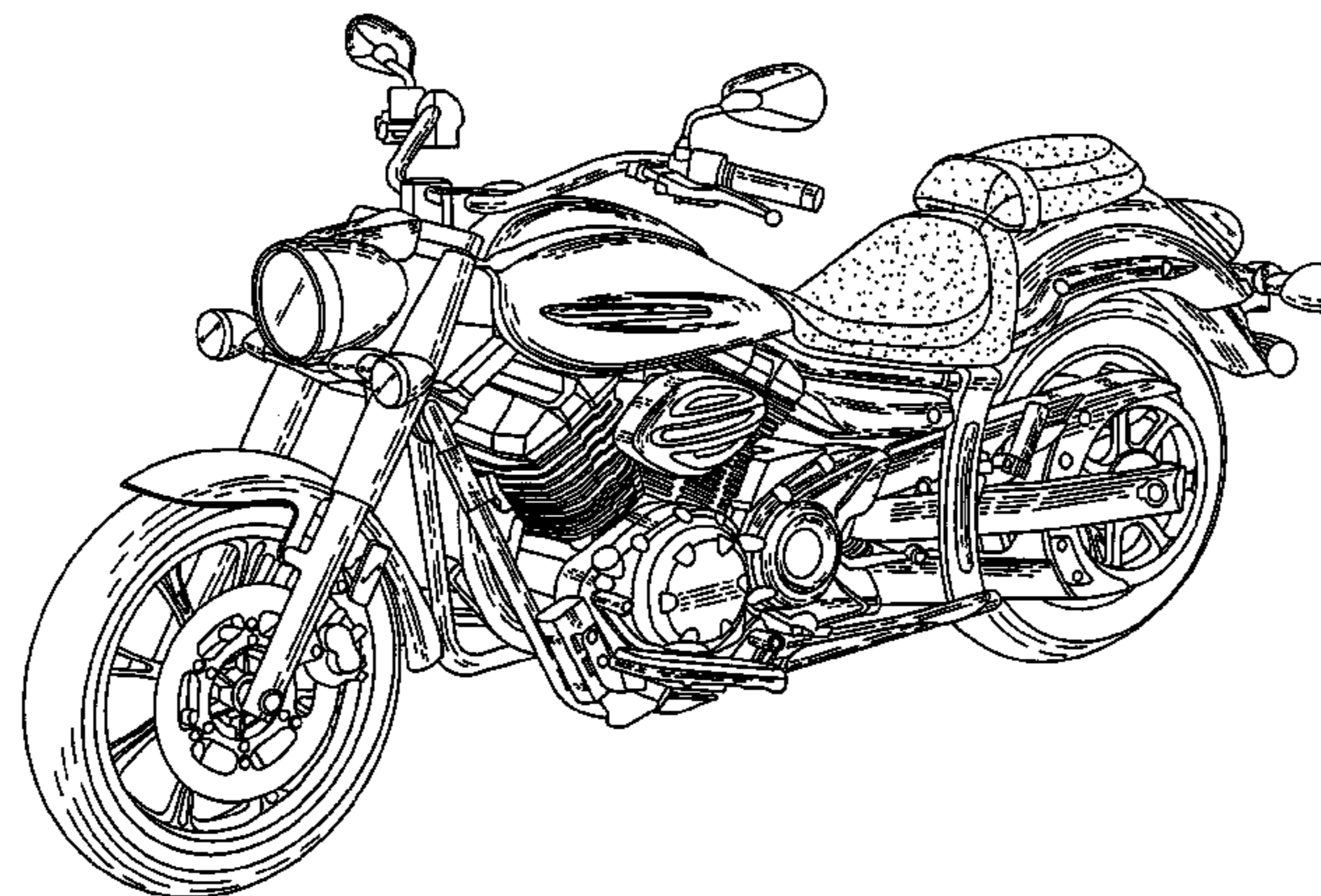

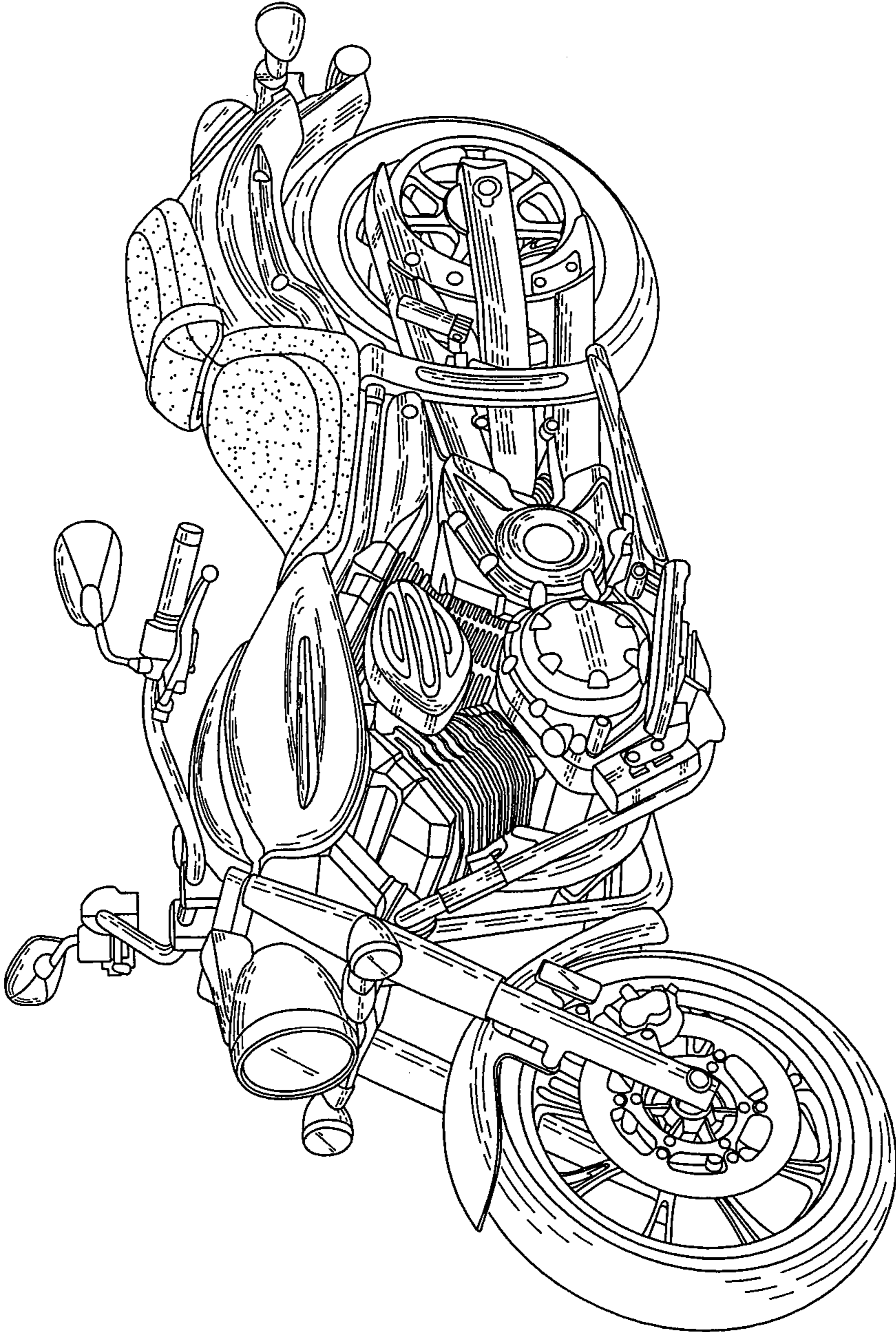

FIG. 1

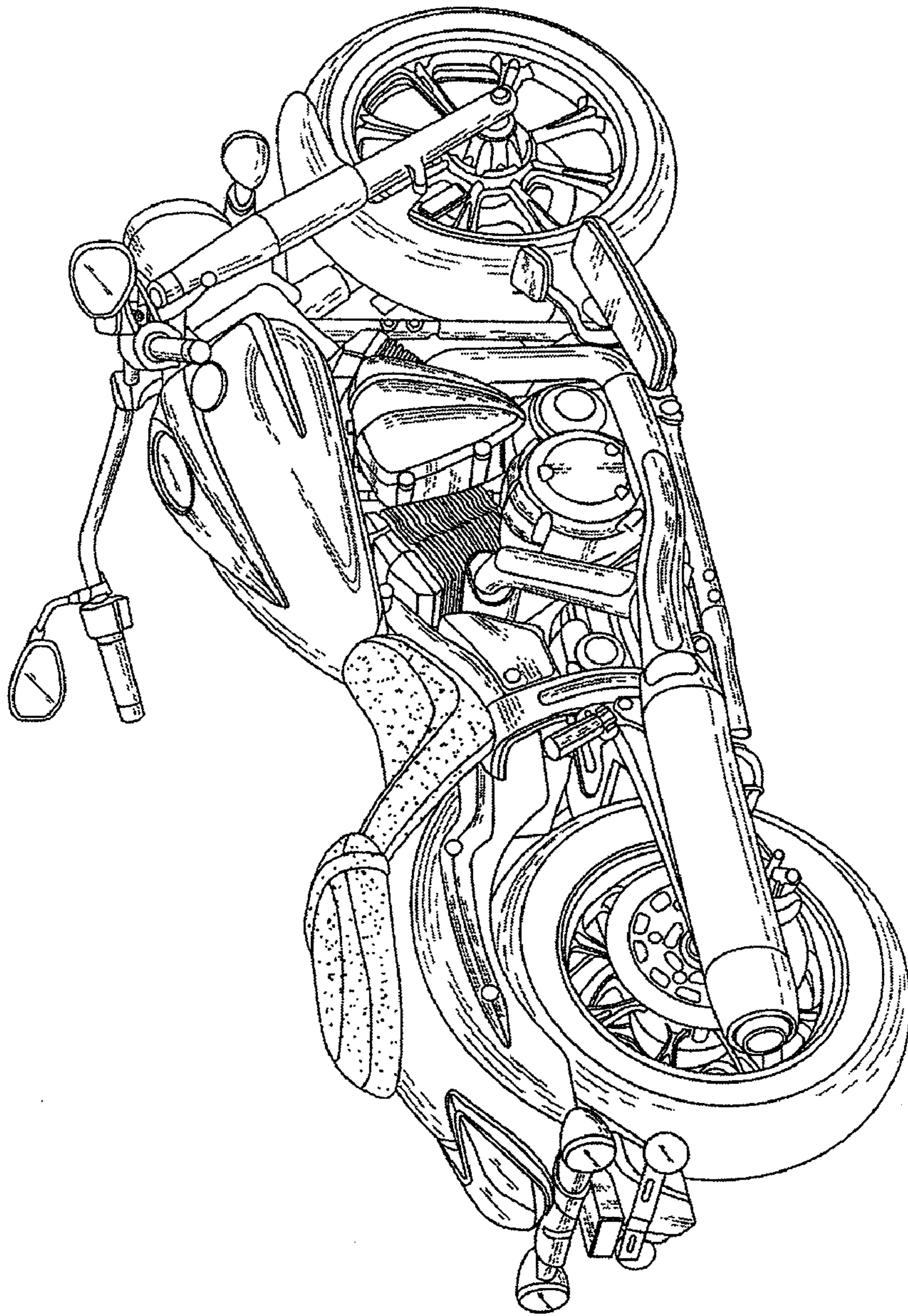

FIG. 2

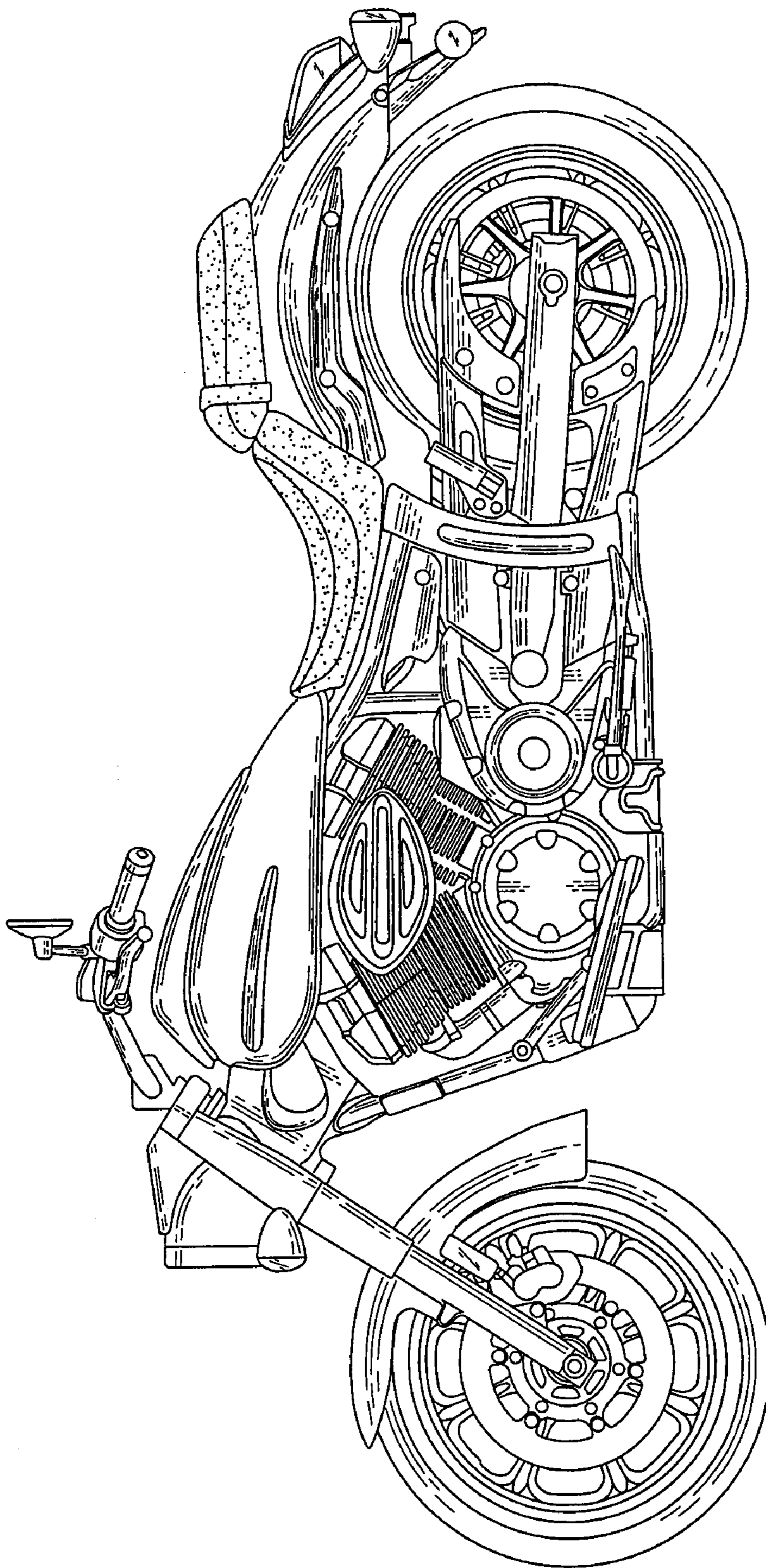

FIG. 3

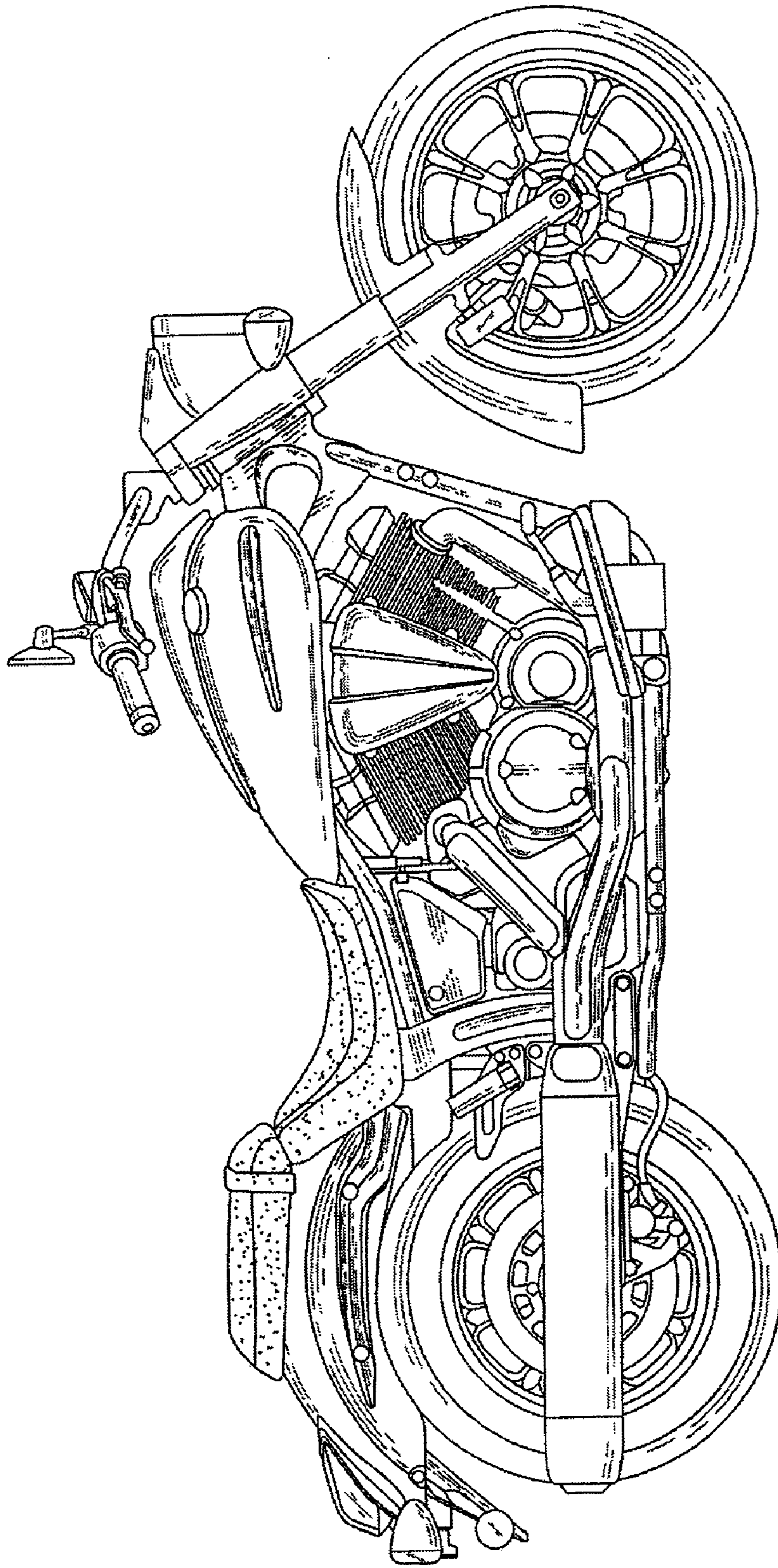

FIG. 4

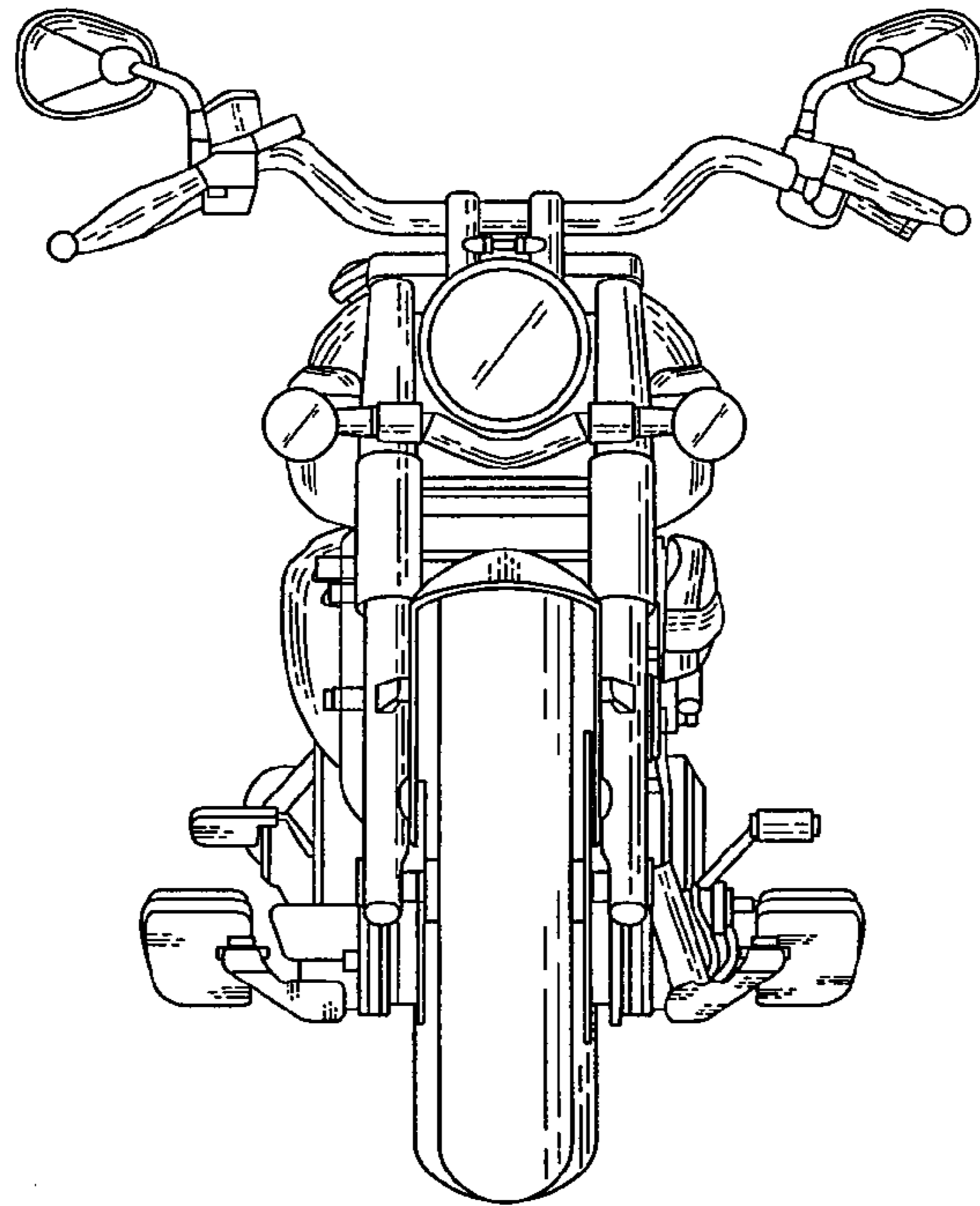

FIG. 5

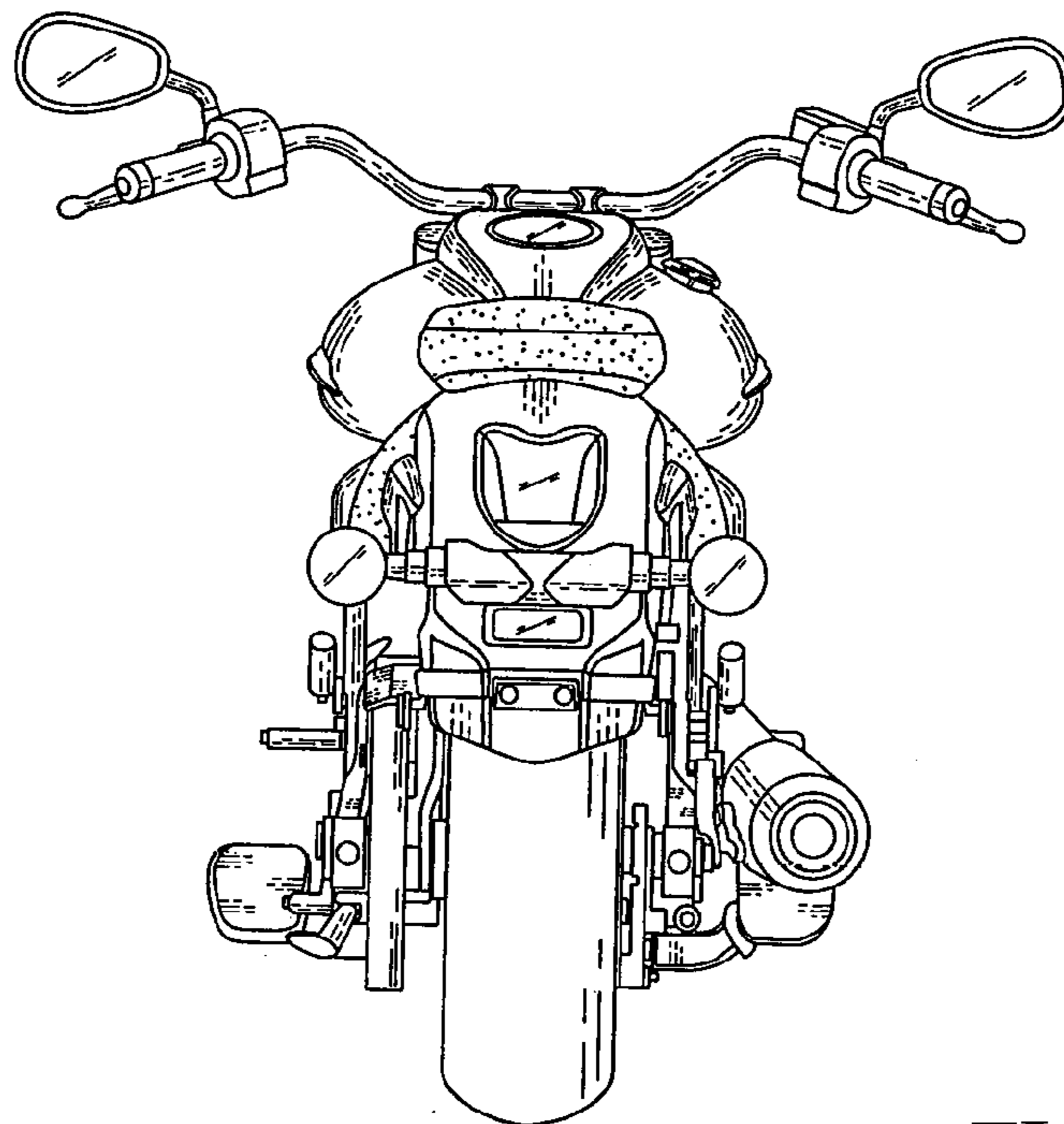

FIG. 6

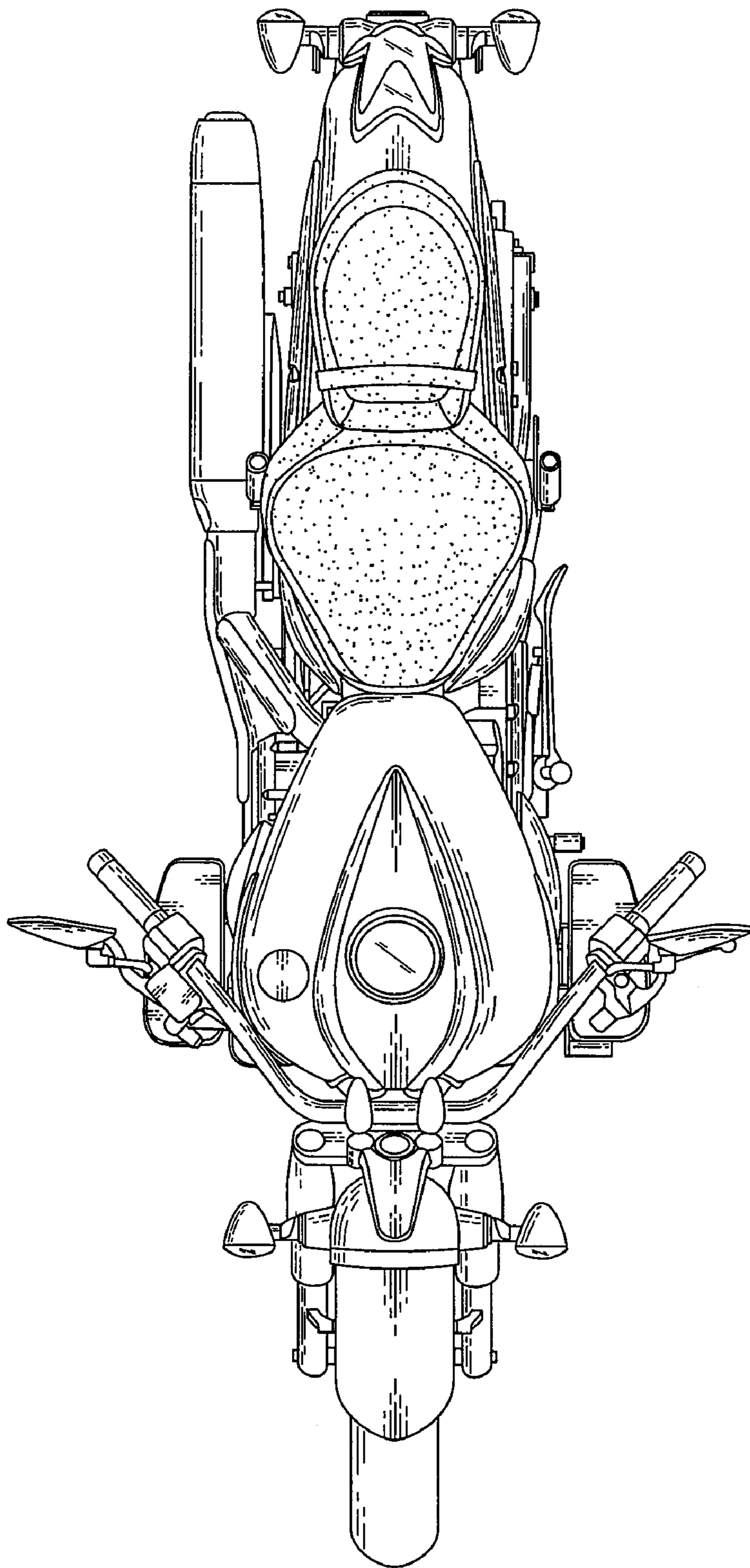

FIG. 7