



US00D597891S

(12) **United States Design Patent**  
**Andoh**

(10) **Patent No.:** **US D597,891 S**

(45) **Date of Patent:** **\*\* Aug. 11, 2009**

(54) **MOTORCYCLE**

(75) **Inventor:** **Seiko Andoh**, Tokyo-to (JP)

(73) **Assignee:** **Yamaha Hatsudoki Kabushiki Kaisha**  
(JP)

(\*\*) **Term:** **14 Years**

(21) **Appl. No.:** **29/324,066**

(22) **Filed:** **Sep. 5, 2008**

(51) **LOC (9) Cl.** ..... **12-11**

(52) **U.S. Cl.** ..... **D12/110**

(58) **Field of Classification Search** ..... D12/110;  
180/219

See application file for complete search history.

(56) **References Cited**

**U.S. PATENT DOCUMENTS**

D391,527 S *	3/1998	Maruyama et al.	.....	D12/110
D511,718 S *	11/2005	Manchester et al.	.....	D12/110
D524,192 S *	7/2006	Sugimoto	.....	D12/110
D567,148 S *	4/2008	Inose et al.	.....	D12/110

**OTHER PUBLICATIONS**

2006 Yamaha Stratoliner. [Retrieved on Mar. 24, 2009]. Retrieved from the Internet <URL: <http://www.motorcycle-usa.com/301/Motorcycle-Photo-Gallery/2006-Yamaha-Stratoliner...>>.\*

\* cited by examiner

*Primary Examiner*—Robin V Webster

*Assistant Examiner*—Linda Brooks

(74) *Attorney, Agent, or Firm*—Ostrolenk, Faber, Gerb & Soffen, LLP

(57) **CLAIM**

The ornamental design for a motorcycle, as shown and described.

**DESCRIPTION**

FIG. 1 is a right side, front perspective view of my new design;

FIG. 2 is a left side, rear perspective view thereof;

FIG. 3 is a right side view thereof;

FIG. 4 is a left side view thereof;

FIG. 5 is a front view thereof;

FIG. 6 is a rear view thereof; and,

FIG. 7 is a top view thereof.

**1 Claim, 7 Drawing Sheets**

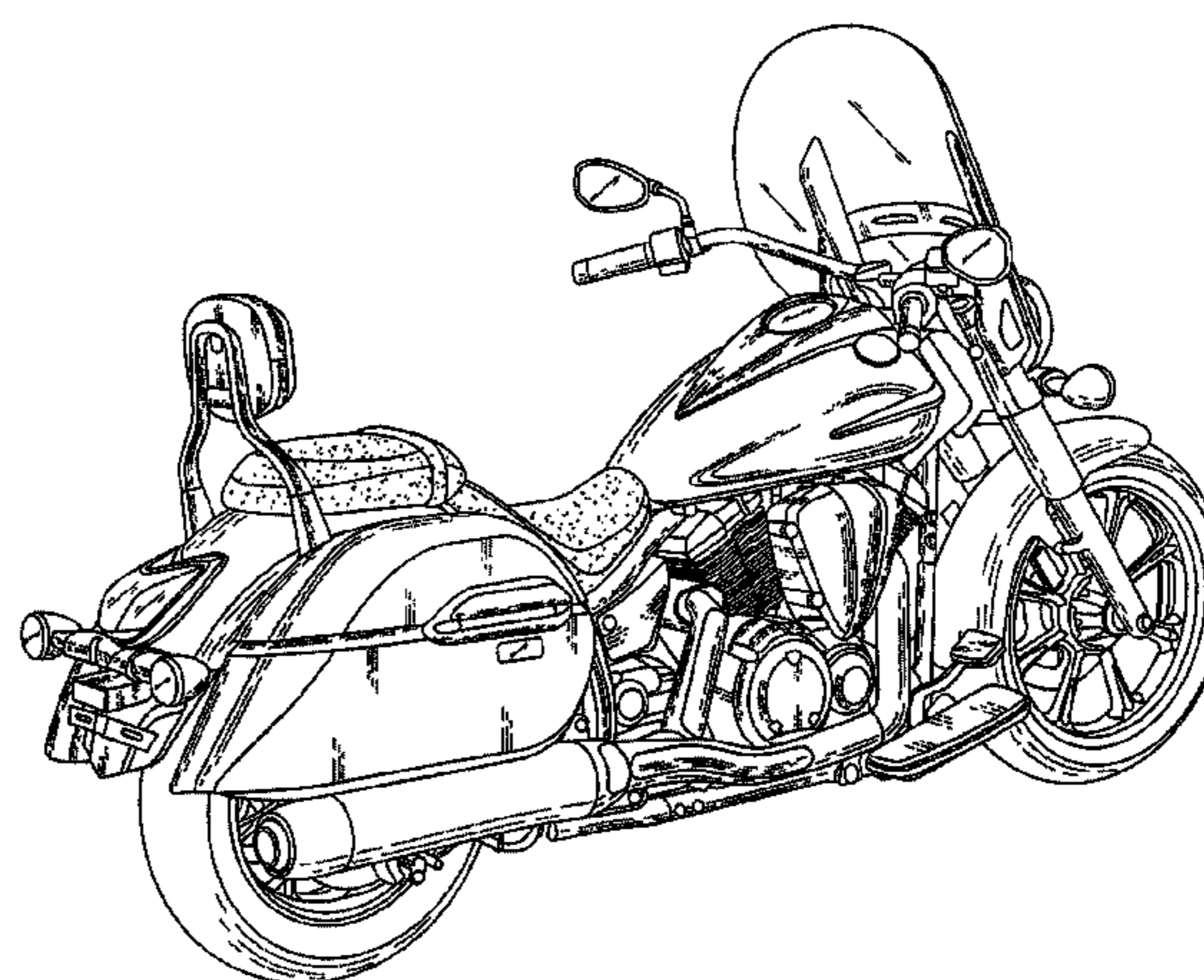
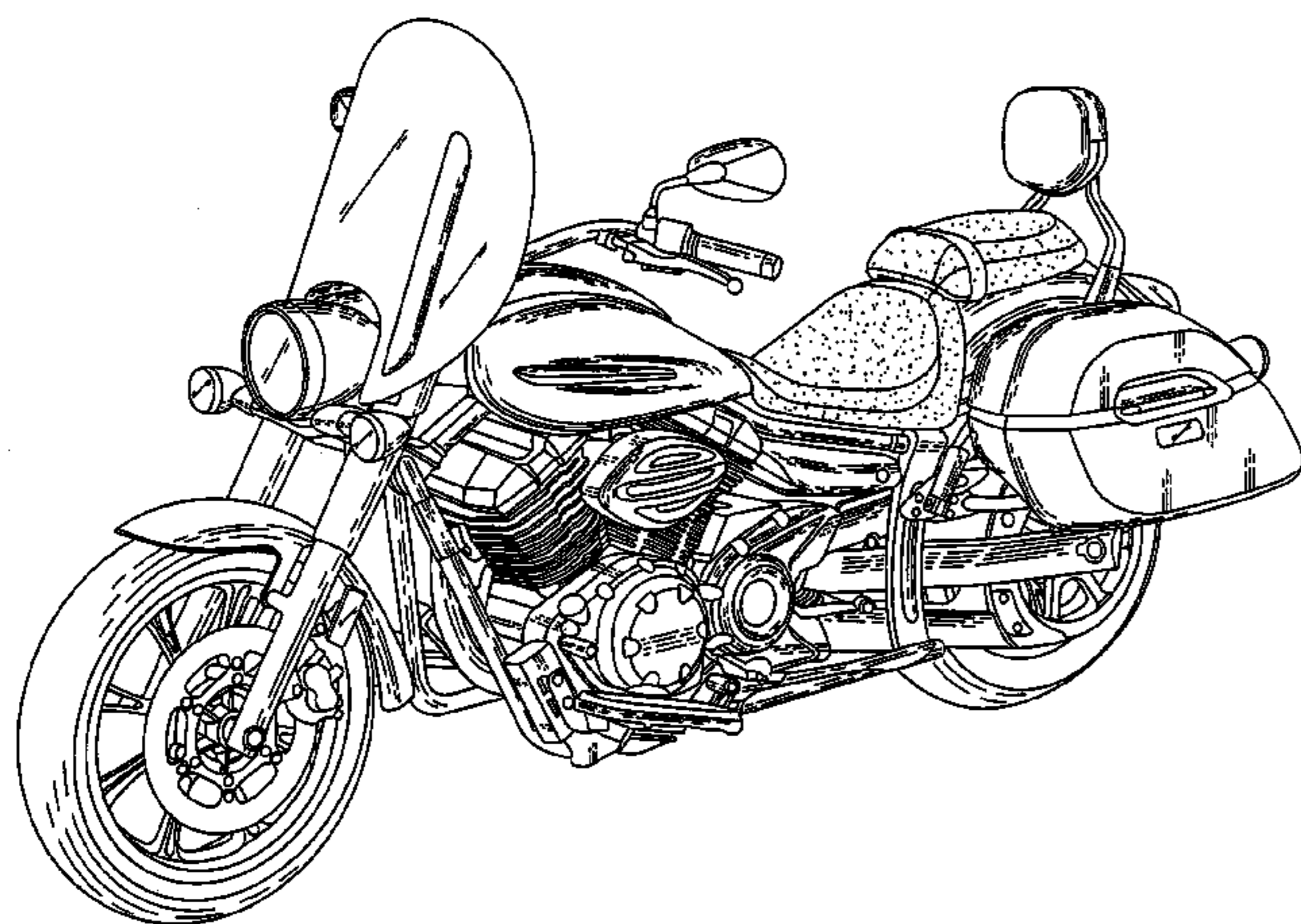

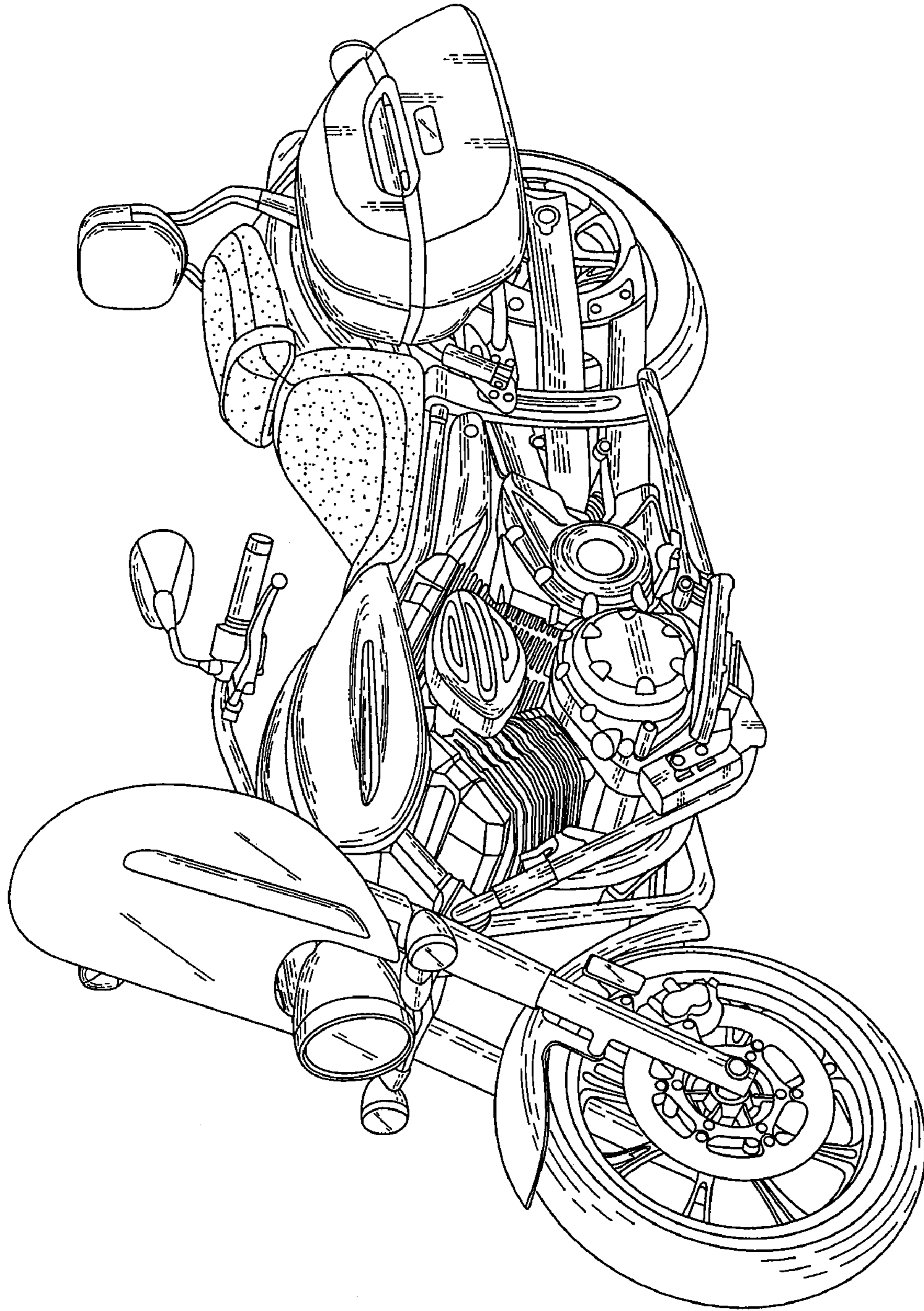

FIG. 1

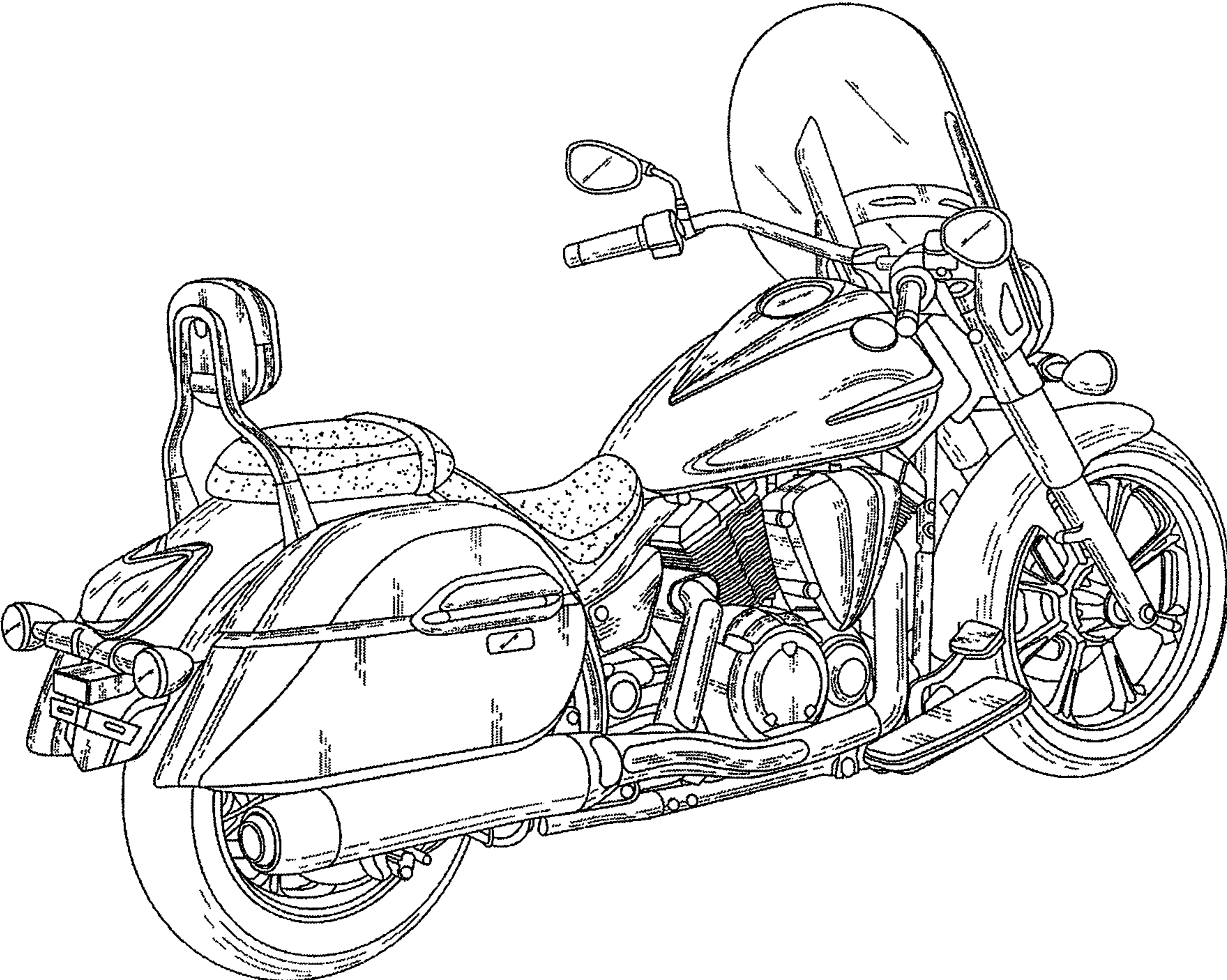

FIG. 2

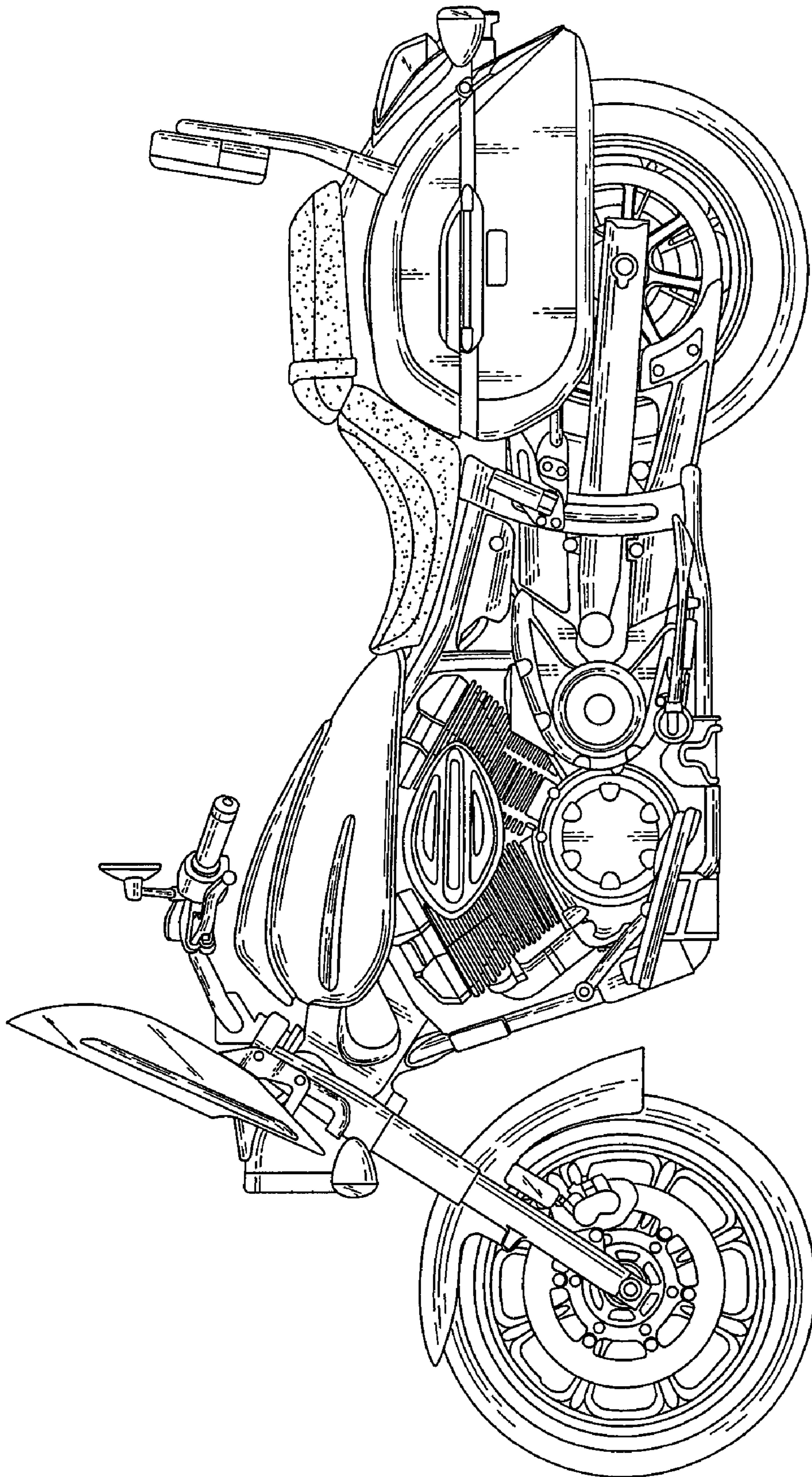

FIG. 3

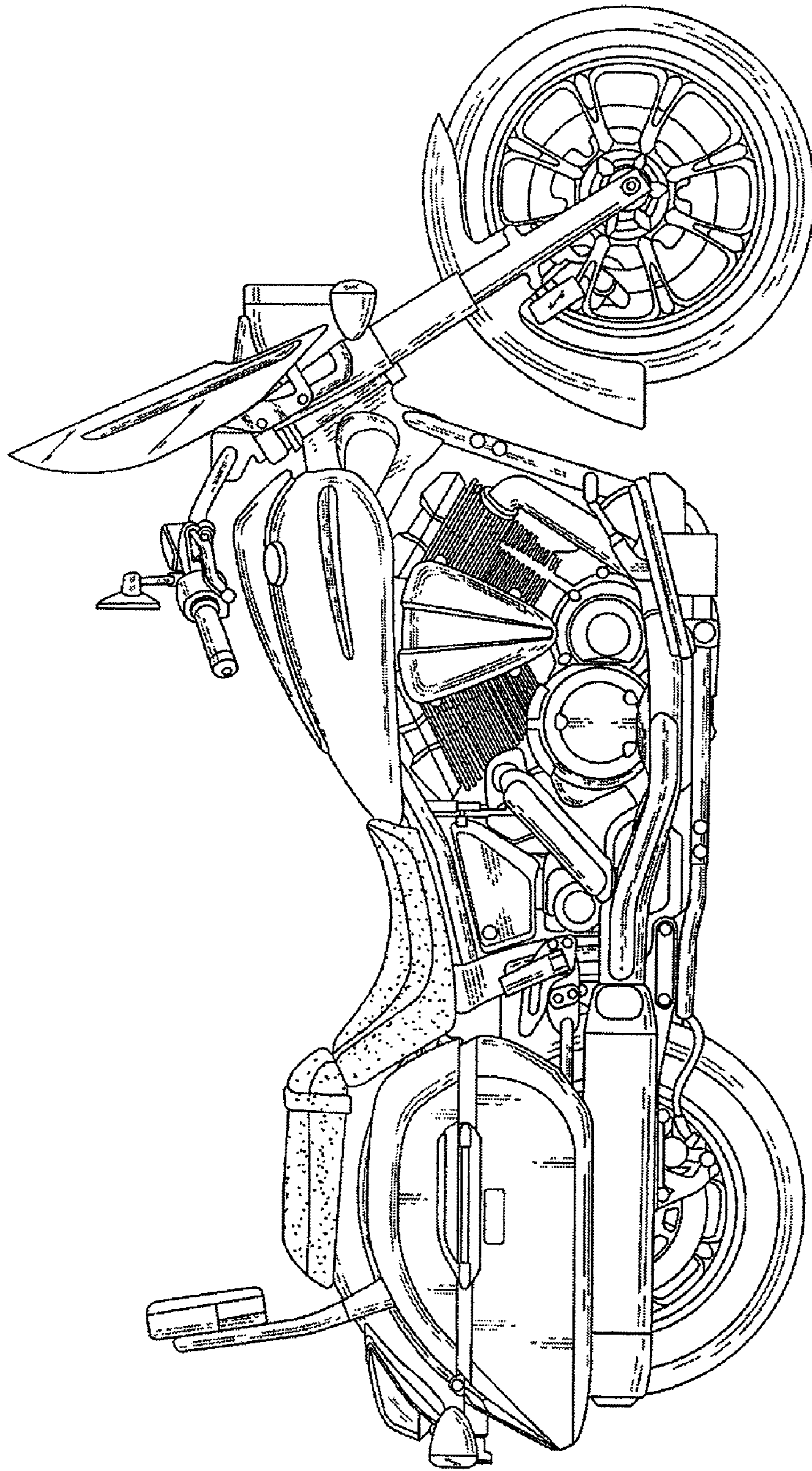

FIG. 4

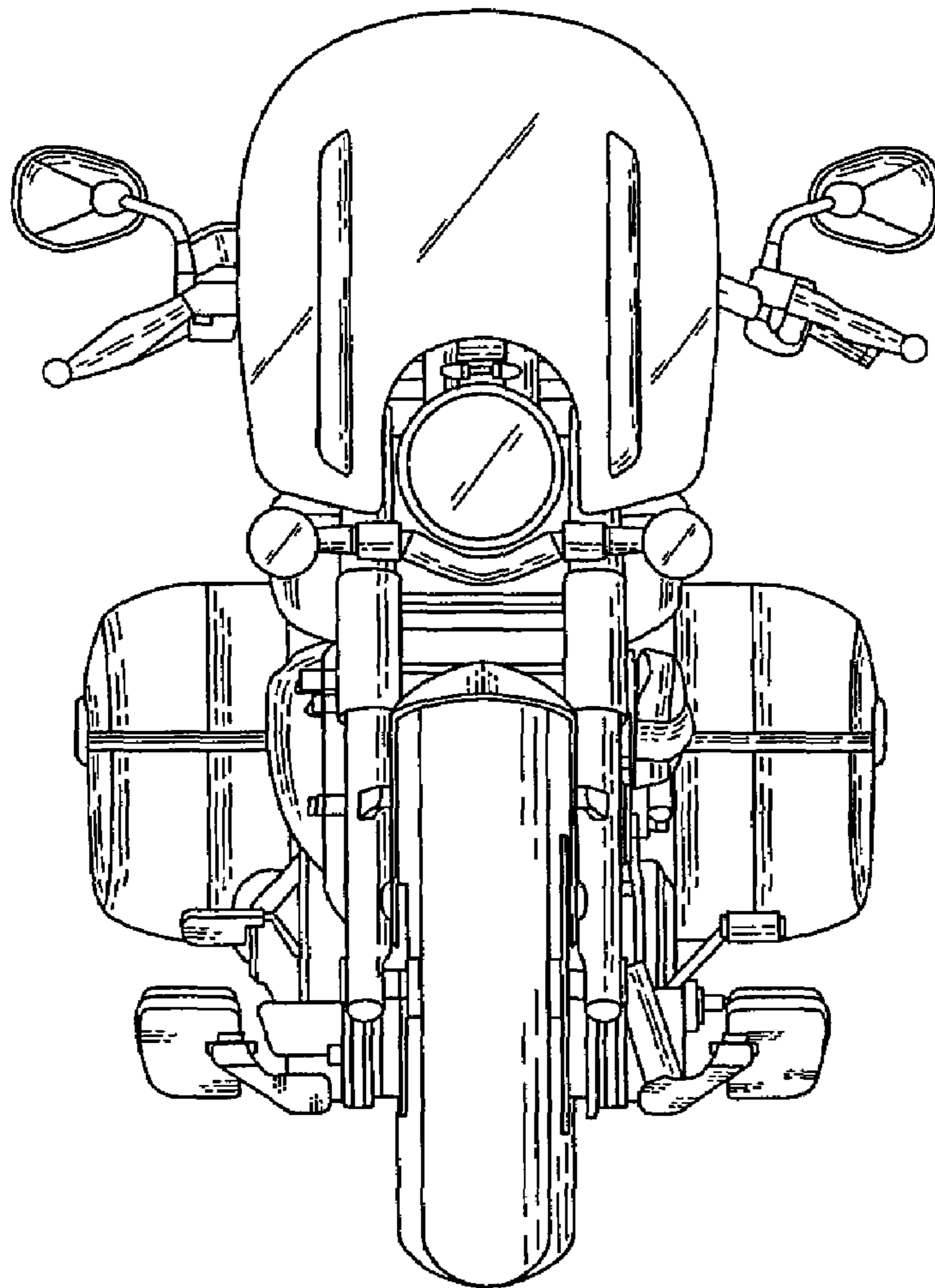

FIG. 5

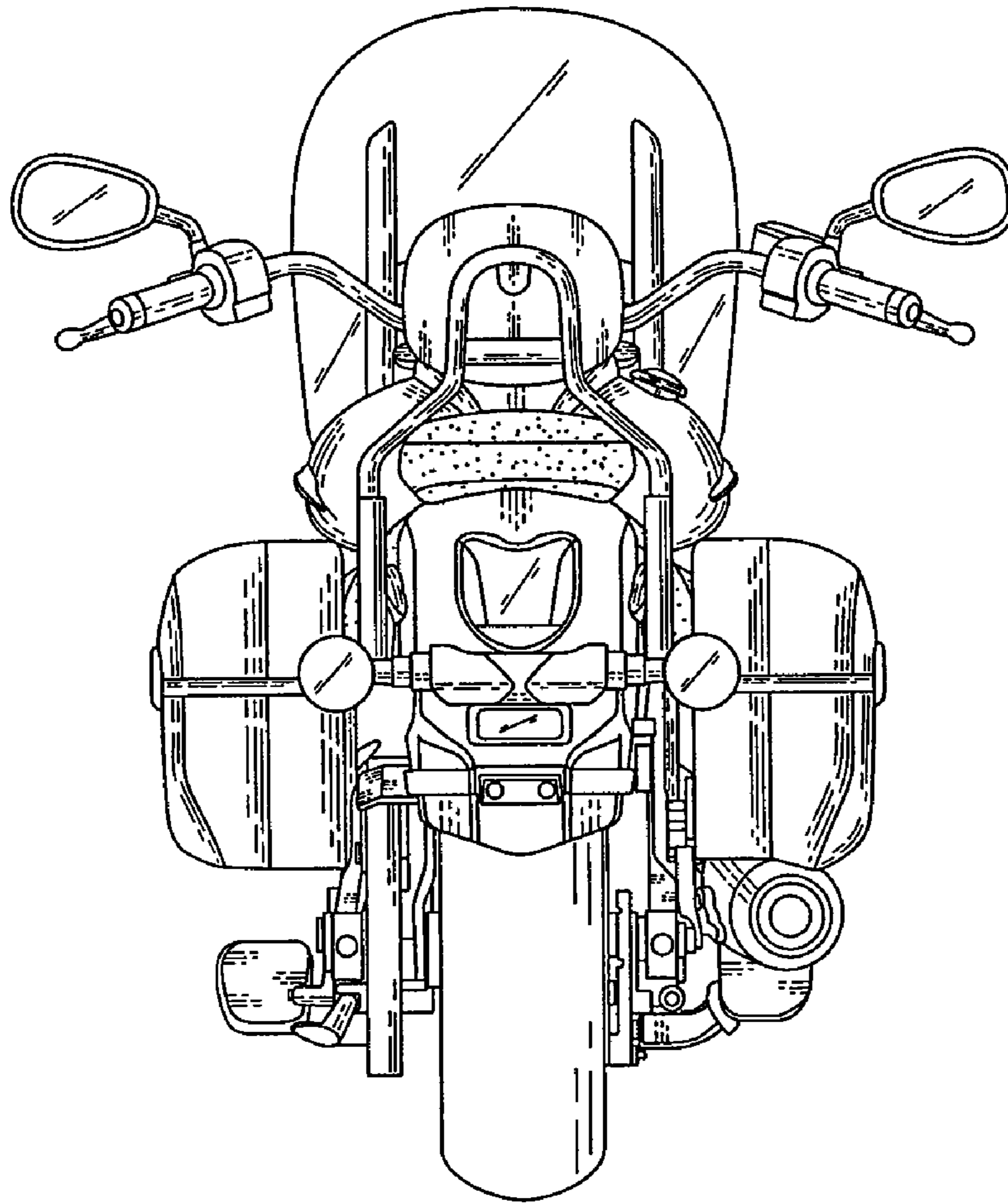

FIG. 6

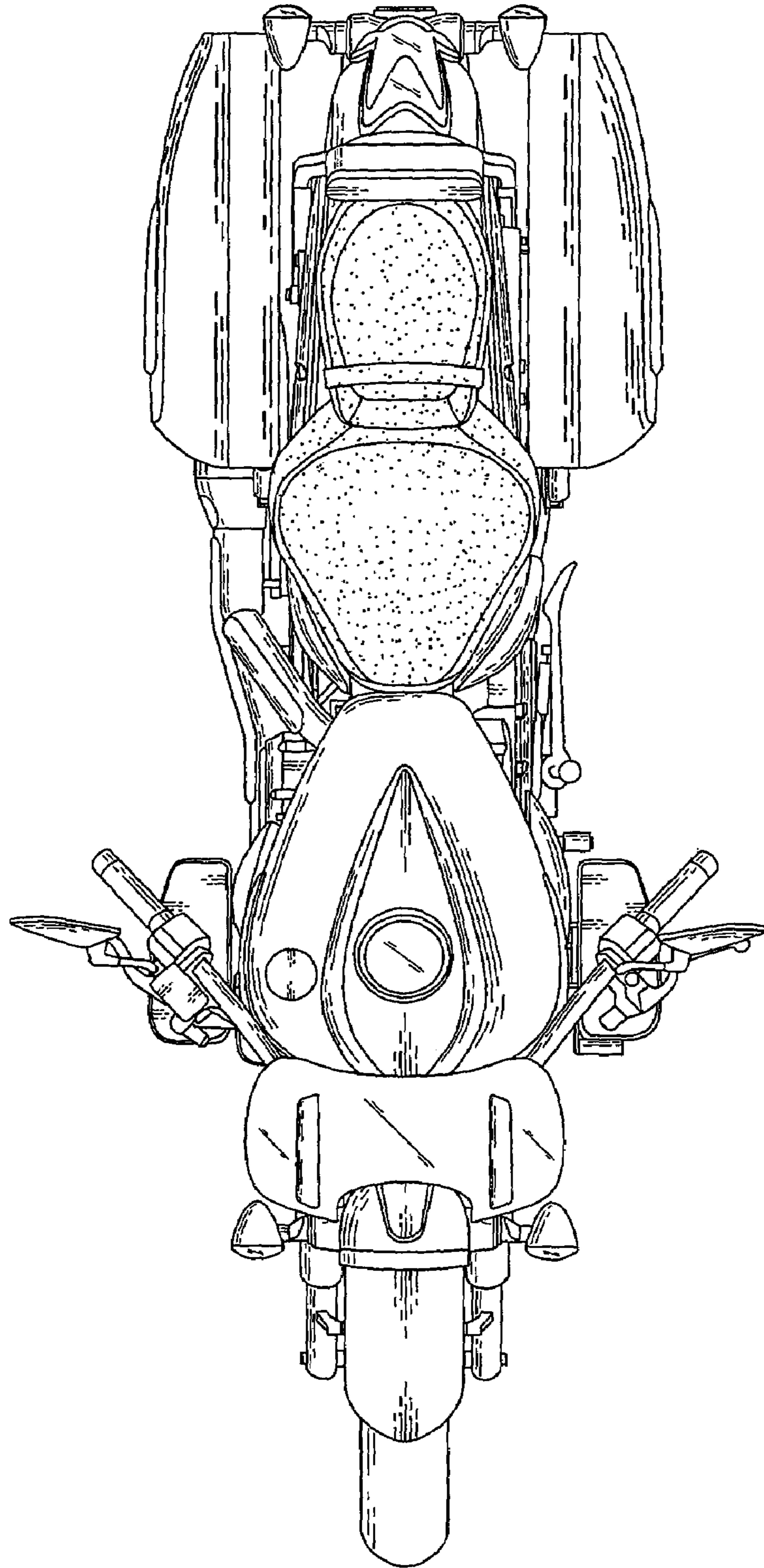

FIG. 7