



US00D597686S

(12) **United States Design Patent**
Noh

(10) **Patent No.:** **US D597,686 S**
(45) **Date of Patent:** **** Aug. 4, 2009**

(54) **FLUORESCENT LAMP**

(75) Inventor: **Si Chung Noh**, 624-8, Seogu-ri,
Gwangjeok-myeon, Yangju-si,
Gyeonggi-do (KR)

(73) Assignee: **Si Chung Noh (KR)**

(**) Term: **14 Years**

(21) Appl. No.: **29/312,023**

(22) Filed: **Sep. 25, 2008**

(51) **LOC (9) Cl.** **26-04**

(52) **U.S. Cl.** **D26/3**

(58) **Field of Classification Search** D26/1-4;
313/313, 315, 317, 318, 493; 315/52, 53,
315/56, 57, 58

See application file for complete search history.

(56) **References Cited**

U.S. PATENT DOCUMENTS

D506,274 S *	6/2005	Moriyama et al.	D26/3
D550,379 S *	9/2007	Hoshikawa et al.	D26/25
D574,093 S *	7/2008	Kitagawa et al.	D26/3
D576,749 S *	9/2008	Kitagawa et al.	D26/3
D577,138 S *	9/2008	Kitagawa et al.	D26/37

* cited by examiner

Primary Examiner—Marcus A. Jackson
(74) *Attorney, Agent, or Firm*—Finnegan, Henderson,
Farabow, Garrett & Dunner, LLP

(57) **CLAIM**

The ornamental design for a fluorescent lamp, as shown and described.

DESCRIPTION

FIG. 1 is a perspective view of the “fluorescent lamp” showing a new design;

FIG. 2 is a front view thereof;

FIG. 3 is a rear view thereof;

FIG. 4 is a left-side view thereof;

FIG. 5 is a right-side view thereof;

FIG. 6 is a top plan view thereof;

FIG. 7 is a bottom view thereof;

FIG. 8 is a partial enlarged perspective view of the left portion thereof;

FIG. 9 is a partial enlarged plan view of the left portion thereof; and,

FIG. 10 is an enlarged left-side view thereof.

1 Claim, 3 Drawing Sheets

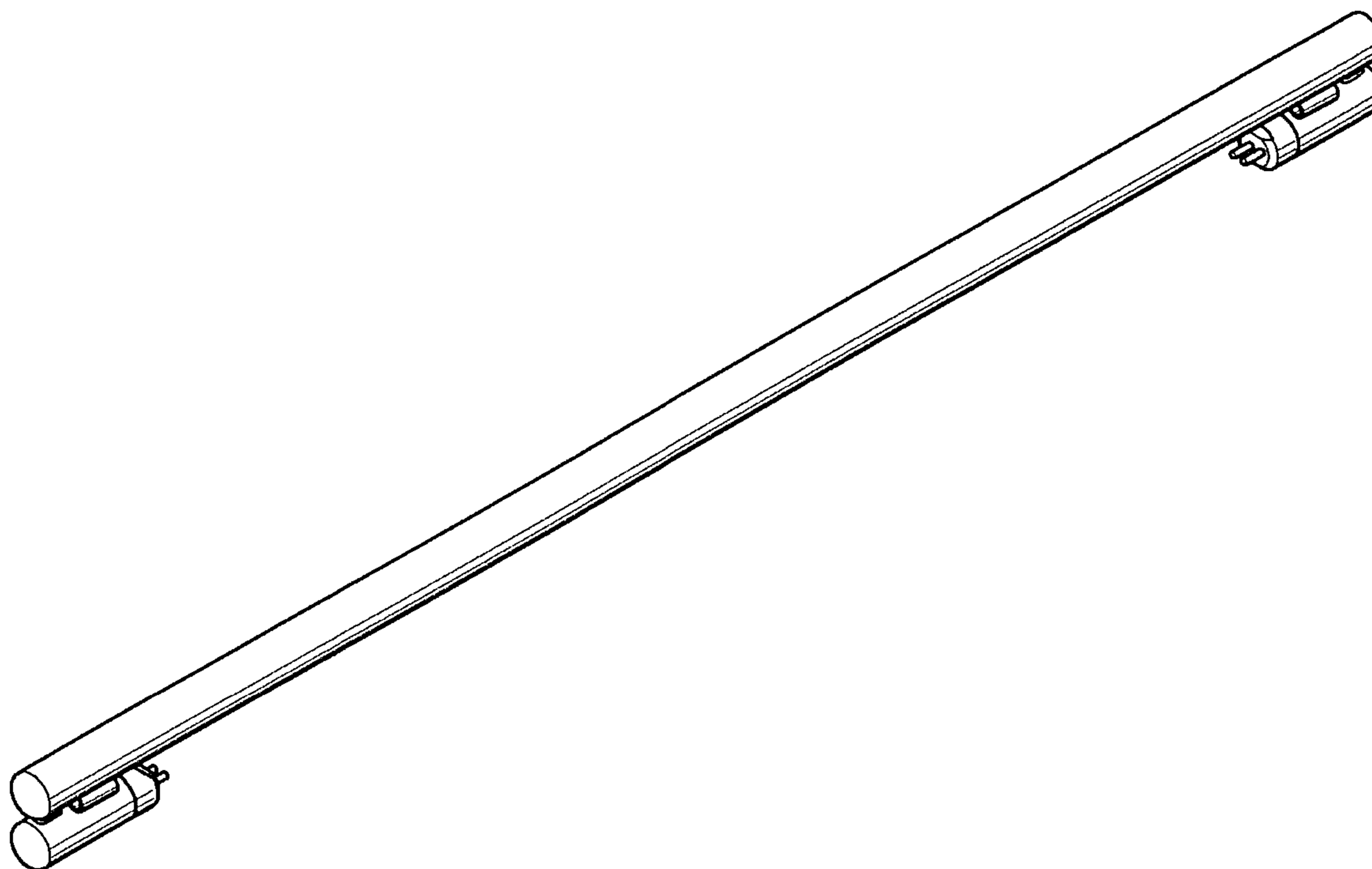

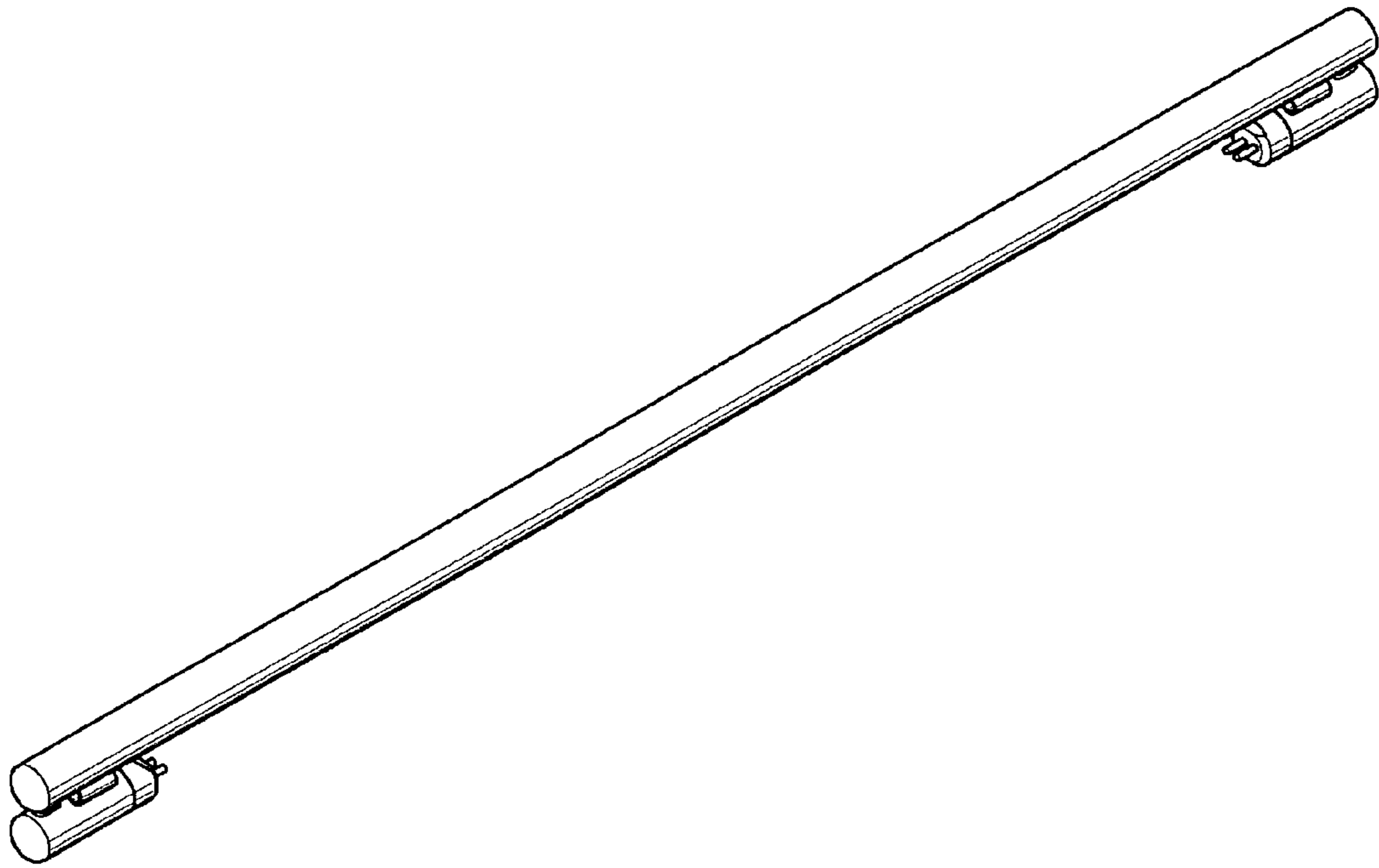

FIG. 1

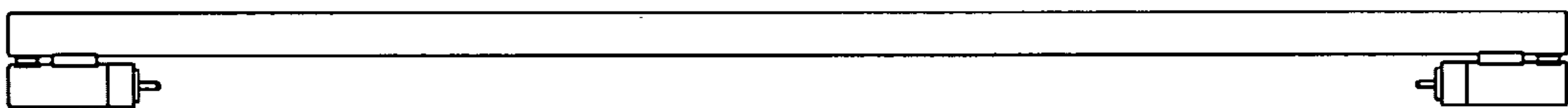

FIG. 2

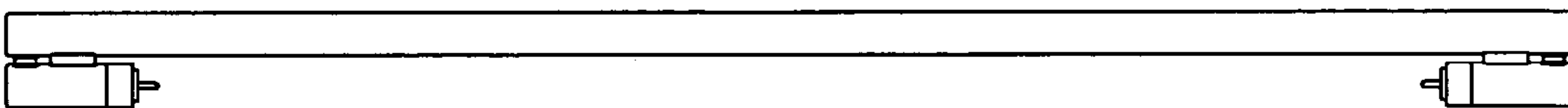

FIG. 3



FIG. 4



FIG. 5



FIG. 6

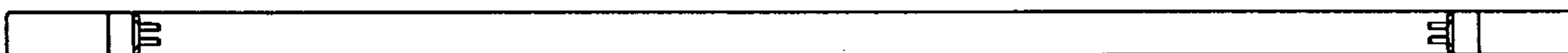

FIG. 7

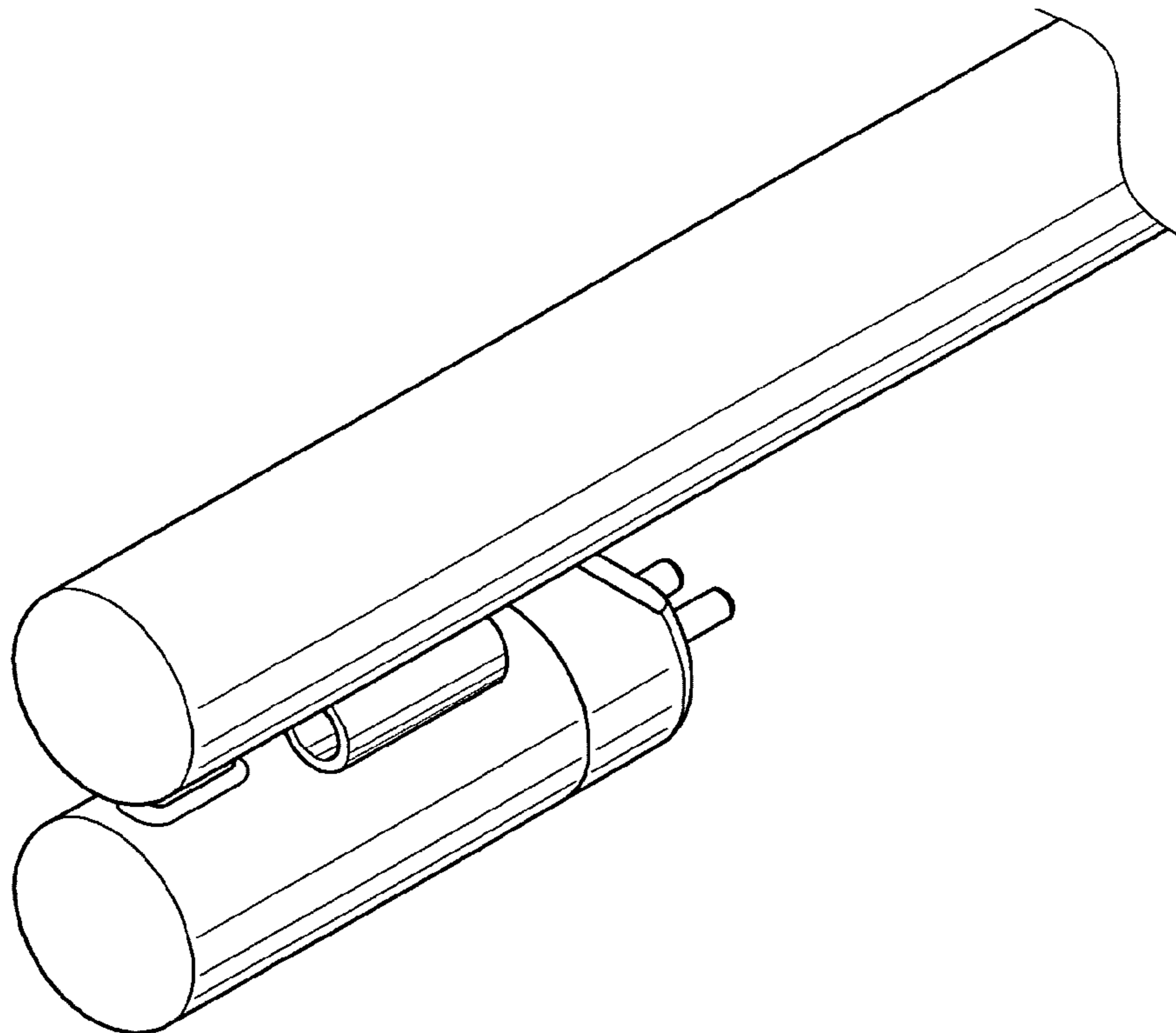

FIG. 8

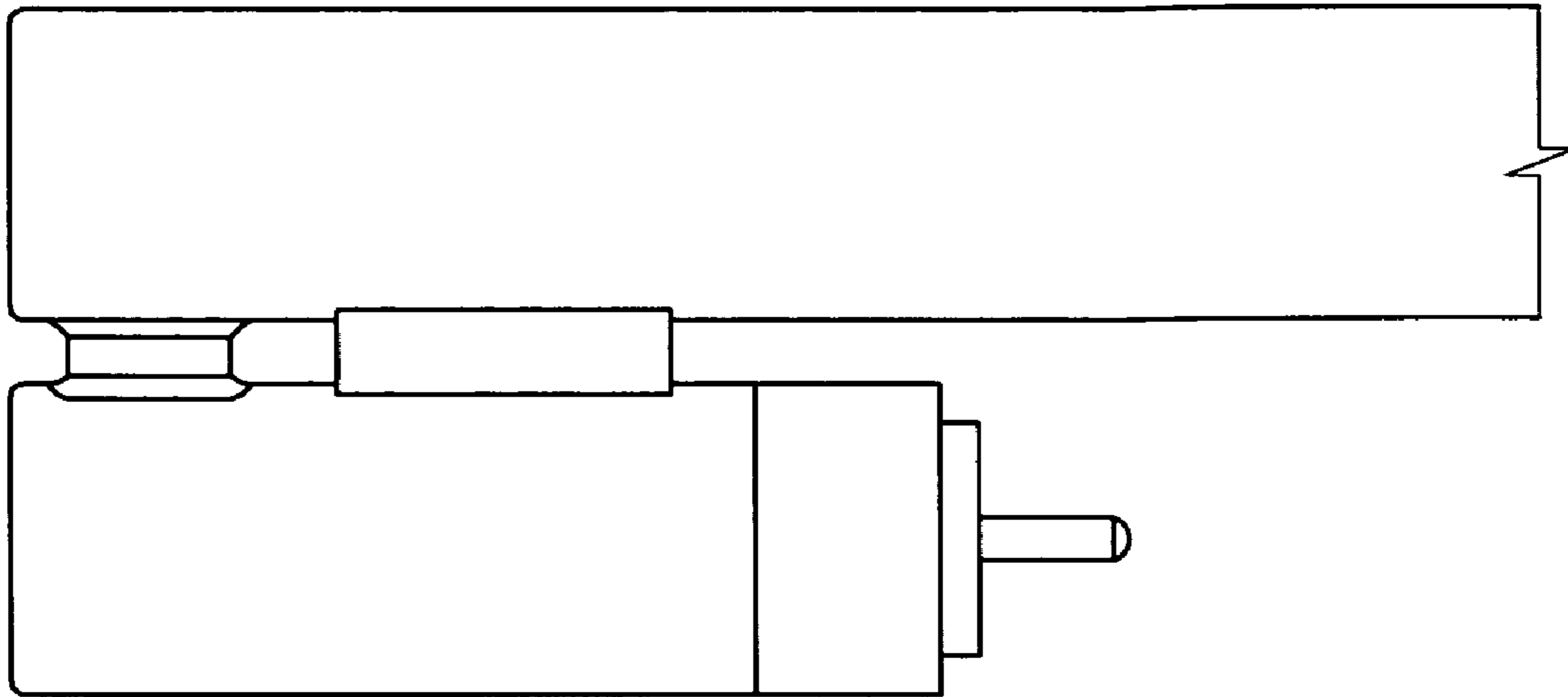

FIG. 9

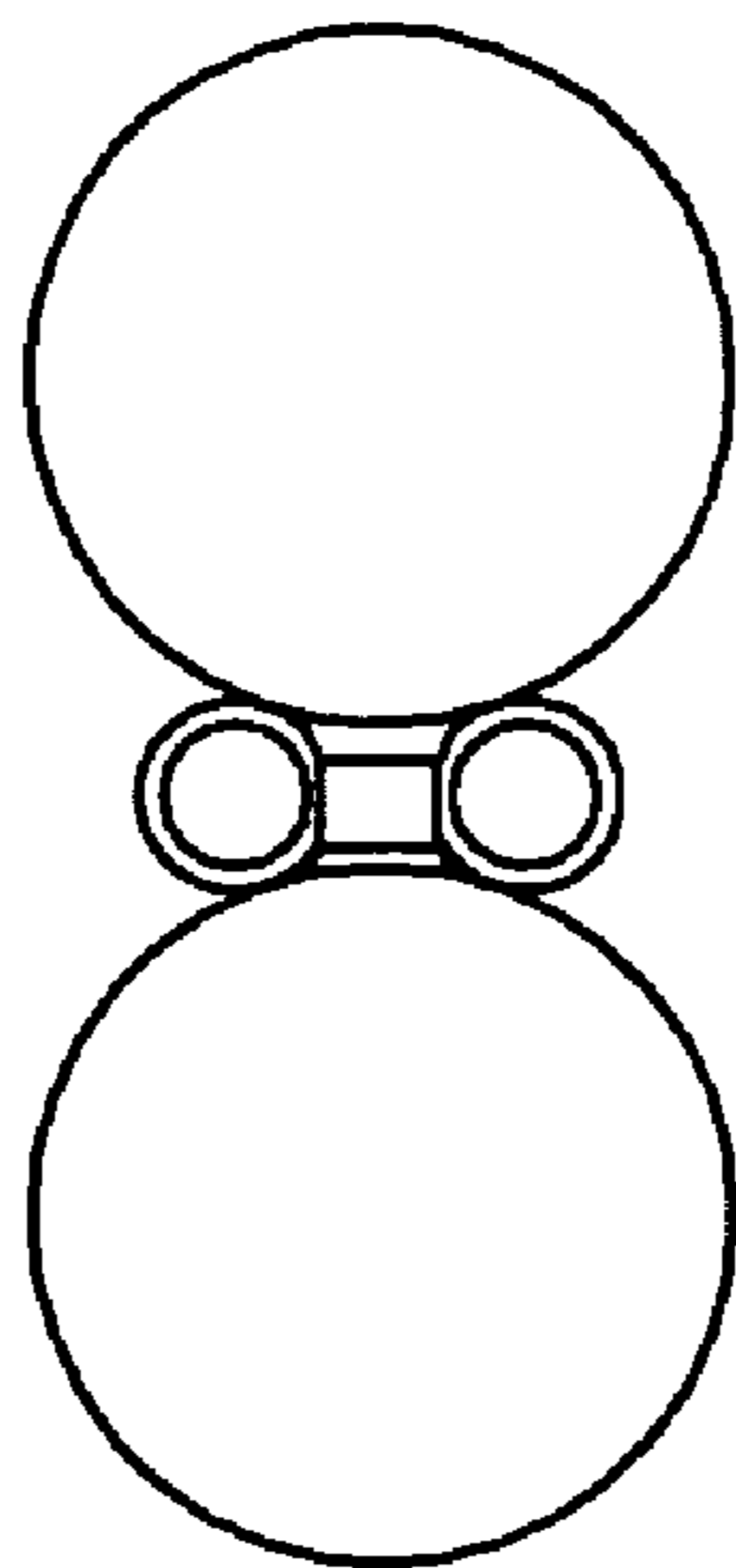

FIG. 10